

Waverunner[™]

OPERATOR'S MANUAL

JANUARY 2002

LeCroy Corporation

700 Chestnut Ridge Road
Chestnut Ridge, NY 10977-6499
Tel: (845) 578 6020, Fax: (845) 578 5985

Internet: www.lecroy.com

© 2002 by LeCroy Corporation. All rights reserved. Information in this publication supersedes all earlier versions. Specifications subject to change.

LeCroy, ProBus and SMART Trigger are registered trademarks, and ActiveDSO, ScopeExplorer, WaveAnalyzer and Waverunner are trademarks, of LeCroy Corporation. Centronics is a registered trademark of Data Computer Corp. Epson is a registered trademark of Epson America Inc. Mathcad is a registered trademark of MATHSOFT Inc. MATLAB is a registered trademark of The MathWorks, Inc. Microsoft, MS and Microsoft Access are registered trademarks, and Windows and NT trademarks, of Microsoft Corporation. PowerPC is a registered trademark of IBM Microelectronics. DeskJet, ThinkJet, QuietJet, LaserJet, PaintJet, HP 7470 and HP 7550 are registered trademarks of Hewlett-Packard Company.

LTXXX-OM-E Rev B





INTRODUCTION..... 1

FIRST THINGS..... 3

When Your Waverunner is Delivered... 3

 CHECK THAT YOU HAVE EVERYTHING 3

 BE SURE TO READ THIS WARRANTY 3

 TAKE ADVANTAGE OF MAINTENANCE AGREEMENTS 4

 OBTAIN ASSISTANCE 4

 RETURN A PRODUCT FOR SERVICE OR REPAIR 4

 STAY UP-TO-DATE 4

 **Safety First** 6

 OPERATE IN A SAFE ENVIRONMENT 6

 GET TO KNOW THE WARNING SYMBOLS..... 6

 CHOOSE THE CORRECT POWER SOURCE 7

 MAINTAIN POWER GROUND 7

 REPLACE WITH THE CORRECT FUSES 8

 CLEAN YOUR WAVERUNNER (BUT LET US MAINTAIN IT)..... 8

Up and Running 9

 GET TO KNOW WAVERUNNER — FRONT PANEL 9

 INSTALL AND POWER UP..... 9

 GET TO KNOW WAVERUNNER — BACK PANEL 10

 INITIALIZE 12

 CHECK YOUR WAVERUNNER SYSTEM 12

 ADD AN OPTION? 13

 UPDATE TO THE LATEST FIRMWARE? 13

 SAVE THE SCREEN (AND ENERGY) 13

 DO YOU PREFER YOUR CONTROLS WITH SOUND AND AUTO-REPEAT? 14

PART ONE: GETTING STARTED 15

CHAPTER ONE: CATCH A NEW WAVE 17

View Your Waveform 17

 USE TIME/DIV TO ADJUST THE TIMEBASE 19

 ADJUST SENSITIVITY AND POSITION 20

 ZOOM AND SCROLL AUTOMATICALLY 20

 USE THE POSITION AND ZOOM CONTROLS..... 22

 SET UP THE TIMEBASE 23

TABLE OF CONTENTS

SET THE COUPLING.....	24
SET UP FOR CAL AND BNC SIGNALS.....	25
CHAPTER TWO: <i>SIMPLY TRIGGER</i>.....	29
Edge Trigger on Simple Signals.....	29
CONTROL TRIGGERING.....	29
SET UP AN EDGE TRIGGER.....	30
USE WINDOW TRIGGER.....	33
TRIGGER SOURCE.....	34
OBTAIN A TRIGGER STATUS SUMMARY.....	35
CHAPTER THREE: <i>DISPLAY YOUR SIGNAL</i>.....	37
Display Persistence.....	37
VIEW SIGNAL CHANGES OVER TIME.....	37
SET UP YOUR DISPLAY.....	38
SET UP FOR PERSISTENCE.....	39
CHOOSE A GRID STYLE.....	40
Save and Recall Your Panel Setups.....	42
SAVE PANEL SETUPS.....	42
RECALL PANEL SETUPS.....	43
CHAPTER FOUR: <i>CHOOSE A MEASURE TOOL</i>.....	45
Measure with Cursors.....	45
CONTROL THE TIME CURSORS.....	45
CONTROL THE AMPLITUDE CURSORS.....	46
Measure Automatically with Parameters.....	50
CHOOSE A STANDARD PARAMETER.....	51
TURN OFF CURSORS AND PARAMETERS.....	52
CHAPTER FIVE: <i>USE MATH TOOLS</i>.....	55
Make Math Easy.....	55
SET UP TO DO WAVEFORM MATHEMATICS.....	56
USE A MATH TOOL.....	57
PERFORM AN FFT OPERATION.....	58
DO SUMMED AVERAGING.....	61
Save and Recall Waveforms.....	63
OBTAIN A WAVEFORM OR MEMORY STATUS REPORT.....	65
CHAPTER SIX: <i>DOCUMENT YOUR WORK</i>.....	67
Make a Hard Copy.....	67
PRINT, PLOT OR COPY.....	68
Manage Floppy or Card Files.....	69
CUSTOMIZE FILE NAMES.....	70
ADD A NEW DIRECTORY.....	71

COPY FILES	72
PART TWO: LOOKING DEEPER.....	75
CHAPTER SEVEN: A QUESTION OF TIMEBASE.....	77
Choose a Sampling Mode.....	77
SINGLE-SHOT — WAVERUNNER'S BASIC CAPTURE TECHNIQUE	77
RIS — FOR HIGHER SAMPLE RATES.....	78
ROLL — DISPLAY IN REAL-TIME.....	78
SEQUENCE — WORKING WITH SEGMENTS.....	79
PAIRING CHANNELS	80
Use a Sampling Mode.....	81
SET UP FOR SINGLE-SHOT OR RIS	81
SET UP FOR SEQUENCE CAPTURE	82
OBTAIN A SEQUENCE STATUS SUMMARY.....	83
OR SAMPLE EXTERNALLY.....	84
CHAPTER EIGHT: TRIGGER SMART.....	87
Hold Off by Time or Events	87
HOLD OFF BY TIME	87
HOLD OFF BY EVENTS	88
Trigger SMART	89
CATCH A GLITCH.....	89
CAPTURE RARE PHENOMENA	93
TRIGGER ON INTERVALS	96
QUALIFY A SIGNAL	100
TRIGGER ON LOST SIGNALS	103
TRIGGER ON TV SIGNALS.....	106
TRIGGER PATTERN	108
CHAPTER NINE: DISPLAY MORE	113
Transform Your Vision	113
“Paint” Your Display	116
CHANGE YOUR PALETTE	117
Set Up XY Display.....	120
CHAPTER TEN: USE ADVANCED MATH TOOLS.....	125
Compute Extrema Waveforms.....	125
Rescale and Assign Units	127
Enhance Resolution	128
Do More with FFT	132
DO FFT AVERAGE	132
DO ADDITIONAL PROCESSING.....	132

TABLE OF CONTENTS

USE CURSORS WITH FFT	132
SET FFT SPAN	135
Use an Advanced Math Function.....	137
Resample to Deskew.....	138
Plot Trends.....	139
READ TRENDS.....	141
CHAPTER ELEVEN: ANALYZE WITH PARAMETERS.....	145
Use Custom Parameters.....	145
CUSTOMIZE A PARAMETER	146
Test for Pass and Fail.....	147
SET UP A PASS/ FAIL TEST.....	147
PASS/ FAIL TEST ON A MASK	148
MAKE A WAVEFORM MASK	149
CHANGE A TEST ACTION.....	149
Choose a Parameter.....	153
CHAPTER TWELVE: USE WEVERUNNER WITH PC.....	161
Transfer Data and Images to PC.....	161
EXPLORE YOUR SCOPE	162
MONITOR YOUR REMOTE CONTROL OPERATIONS.....	163
Save Waveforms in ASCII.....	164
SAVE IN AN ASCII FORMAT.....	165
Use ASCII Formats.....	167
SAVE TO SPREADSHEET.....	167
PLOT A WAVEFORM IN SPREADSHEET	170
USE MATHCAD	171
USE MATLAB	173
PART THREE: WAVA OPTION	175
CHAPTER THIRTEEN: PARAMETERS.....	177
A Valuable Tool for Waveform Analysis.....	177
SET UP FOR HISTOGRAMS	177
PARAMETER MATH.....	185
CHAPTER FOURTEEN: MAKING HISTOGRAMS.....	191
Create and View a Histogram.....	191
SETTING BINNING AND SCALE.....	196
CHOOSING HISTOGRAM PARAMETERS.....	200
USING MEASUREMENT CURSORS	201
ZOOMING SEGMENTED TRACES.....	203
CHAPTER FIFTEEN: HOW HISTOGRAMS WORK.....	205
Theory of Operation.....	205



DSO PROCESS.....	206
PARAMETER BUFFER	206
CAPTURE OF PARAMETER EVENTS	207
HISTOGRAM PARAMETERS	207
ZOOM TRACES AND SEGMENTED WAVEFORMS	208
HISTOGRAM PEAKS.....	208
BINNING AND MEASUREMENT ACCURACY.....	209
CHAPTER SIXTEEN : HISTOGRAM PARAMETERS	211
avg	211
fwhm.....	212
fwxx.....	213
hampl.....	214
H base	215
high.....	216
hmedian.....	217
hrms.....	218
htop.....	219
low	220
maxp.....	221
mode	222
pctl.....	223
pks	224
range.....	226
sigma	227
totp.....	228
xapk.....	229
APPENDIX: ARCHITECTURE AND SPECIFICATIONS.....	231
Instrument Architecture Overview.....	231
PROCESSORS.....	231
ADCs	231
MEMORIES.....	231
RIS.....	231
TRIGGER SYSTEM	231
AUTOMATIC CALIBRATION	232
DISPLAY SYSTEM	232
INTERFACE AND PANEL SETUPS.....	232
REMOTE CONTROL	232
Specifications.....	234
MODELS.....	234
 ACQUISITION SYSTEM	234
TIMEBASE SYSTEM.....	235

TABLE OF CONTENTS

TRIGGERING SYSTEM.....	236
SMART TRIGGER TYPES.....	236
AUTOSETUP.....	237
PROBES.....	237
COLOR WAVEFORM DISPLAY.....	237
ANALOG PERSISTENCE DISPLAY.....	237
ZOOM EXPANSION TRACES.....	237
RAPID SIGNAL PROCESSING.....	238
INTERNAL WAVEFORM MEMORY.....	238
SETUP STORAGE.....	238
MATH TOOLS.....	238
MEASURE TOOLS.....	239
EXTENDED MATH AND MEASUREMENTS OPTION.....	239
WAVEANALYZER OPTION.....	239
SPECIAL APPLICATION SOLUTIONS.....	239
INTERFACE.....	240
OUTPUTS.....	240
 GENERAL.....	240
<i>GLOSSARY OF TECHNICAL TERMS.....</i>	243





About this Manual

Like the Waverunner scope itself, this manual is designed to make your measurements as easy as “1–2–3.” Each section shows you step by step how to use the oscilloscope to solve simple or complex problems.

Use the manual with Waverunner in front of you. Then you’ll see clearly just what is being referred to; and you can immediately put into action what is described.

The manual has two main parts:

Part One, “Getting Started,” is for new users and basic operations. It explains the most important Waverunner features, and shows you how to apply them. Use it when starting out and for getting quick results.

Part Two, “Looking Deeper,” goes into more detail. It explains how to perform complex measurements using more advanced Waverunner functions. It also looks more deeply into operations covered in Part One. Use it for tackling demanding tasks, or as a reference for understanding better how your scope works.

Consult the glossary for clarification of oscilloscope and related terms.

As an additional guide, each chapter is prefaced by a summary of its contents.

Watch for panels and sections throughout the manual marked by these icons:

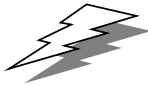

TIPS offer additional hints on how to get the most out of Waverunner actions or features.



NOTES bring to your attention important information you should know.



The sections marked by the magnifying glass, and printed in *italic text*, “zoom” on particular topics. They offer more information on the subject, where appropriate.



FIRST THINGS... *First*

In this preface, see how

To make sure you have everything

To operate with safety

To get to know your Waverunner scope

To install and power up

To initialize

To check the system status

To install new software and firmware

To activate the screen saver

To use menus, menu buttons and knobs

To choose button and knob preferences



When Your Waverunner is Delivered

CHECK THAT YOU HAVE EVERYTHING

First, verify that all items on the packing list or invoice copy have been shipped to you. (The items are also listed below.) Second, check the SYSTEM STATUS display once your Waverunner oscilloscope is installed (see page 12). Contact your nearest LeCroy customer service center or national distributor if anything is missing or damaged. If there is something missing or damaged, and you do not contact us immediately, we cannot be responsible for replacement.

The following is shipped with the standard Waverunner scope:

10:1 10 M Ω PP006 Passive Probe — one per channel

AC Power Cord and Plug

Performance or Calibration Certificate

Front Scope Cover

Two 250 V Fuses

Operator's Manual

Remote Control Manual

Quick Reference Guide

Declaration of Conformity.

NOTE: The warranty below replaces all other warranties, expressed or implied, including but not limited to any implied warranty of merchantability, fitness, or adequacy for any particular purpose or use. LeCroy shall not be liable for any special, incidental, or consequential damages, whether in contract or otherwise. The customer is responsible for the transportation and insurance charges for the return of products to the service facility. LeCroy will return all products under warranty with transport prepaid.

BE SURE TO READ THIS WARRANTY

The Waverunner oscilloscope is warranted for normal use and operation, within specifications, for a period of three years from shipment. LeCroy will either repair or, at our option, replace any product returned to one of our authorized service centers within this period. However, in order to do this we must first examine the product and find that it is defective due to workmanship or materials and not due to misuse, neglect, accident, or abnormal conditions or operation.

Spare and replacement parts, and repairs, all have a 90-day warranty.

The oscilloscope's firmware has been thoroughly tested and is presumed to be functional. Nevertheless, it is supplied without warranty of any kind covering detailed performance. Products not made by LeCroy are covered solely by the warranty of the original equipment manufacturer.

TAKE ADVANTAGE OF MAINTENANCE AGREEMENTS

We offer a variety of services under the heading of Maintenance Agreements. These give extended warranty and allow you to budget maintenance costs after the initial three-year warranty has expired. Installation, training, enhancements, and on-site repairs — among other services — are available through special supplemental support agreements. Inquire at your LeCroy customer service center or national distributor.

OBTAIN ASSISTANCE

Help with installation, calibration, and the use of your Waverunner scope in a range of applications is also available from your customer service center.

RETURN A PRODUCT FOR SERVICE OR REPAIR

If you do need to return a LeCroy product, identify it by its model and serial numbers (see page 12). Describe the defect or failure, and provide your name and contact number.

For factory returns, use a Return Authorization Number (RAN), obtainable from customer service. Attach it so that it can be clearly seen on the outside of the shipping package to ensure rapid forwarding within LeCroy.

Return those products requiring only maintenance to your customer service center.

Within the warranty period, transportation charges to the factory will be your responsibility, while products under warranty will be returned to you with transport prepaid by LeCroy. Outside the warranty period, you will have to provide us with a purchase order number before the work can be done. You will be billed for parts and labor related to the repair work, as well as for shipping.

You should prepay return shipments. LeCroy cannot accept COD (Cash On Delivery) or Collect Return shipments. We recommend using air freight.

STAY UP-TO-DATE

To maintain your Waverunner scope's performance within specifications, have us calibrate it at least once a year. LeCroy offers state-of-the-art technology by continually refining and improving the instrument's capabilities and operation. We frequently update both firmware and software during service, free of charge during warranty.

You can also install new firmware yourself, without the need of a factory refit. Simply provide us with your Waverunner serial number and ID, and the version number of the software already installed (see page 12), along with ordering information. We will provide you with a unique option key that has a code to be entered through the instrument's front panel to upgrade your software. In addition, the very latest versions of LeCroy's unique oscilloscope software applications can be downloaded from the Internet, free of charge. Included are ScopeExplorer™ and ActiveDSO.

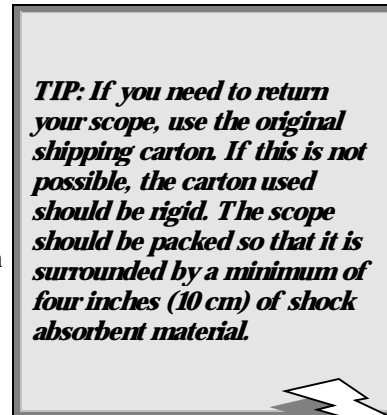

ScopeExplorer is a highly practical PC-based connectivity tool that interfaces Waverunner to a PC that is running Microsoft® Windows™, via the rear panel GPIB (IEEE 488) or RS-232 port. Specially designed by LeCroy for its oscilloscopes, ScopeExplorer allows you to perform data and image transfers and other remote operations from scope to PC with just a few keyboard strokes or mouse clicks. See Chapter 12, “Use Waverunner with PC,” for more about using ScopeExplorer with your Waverunner scope.

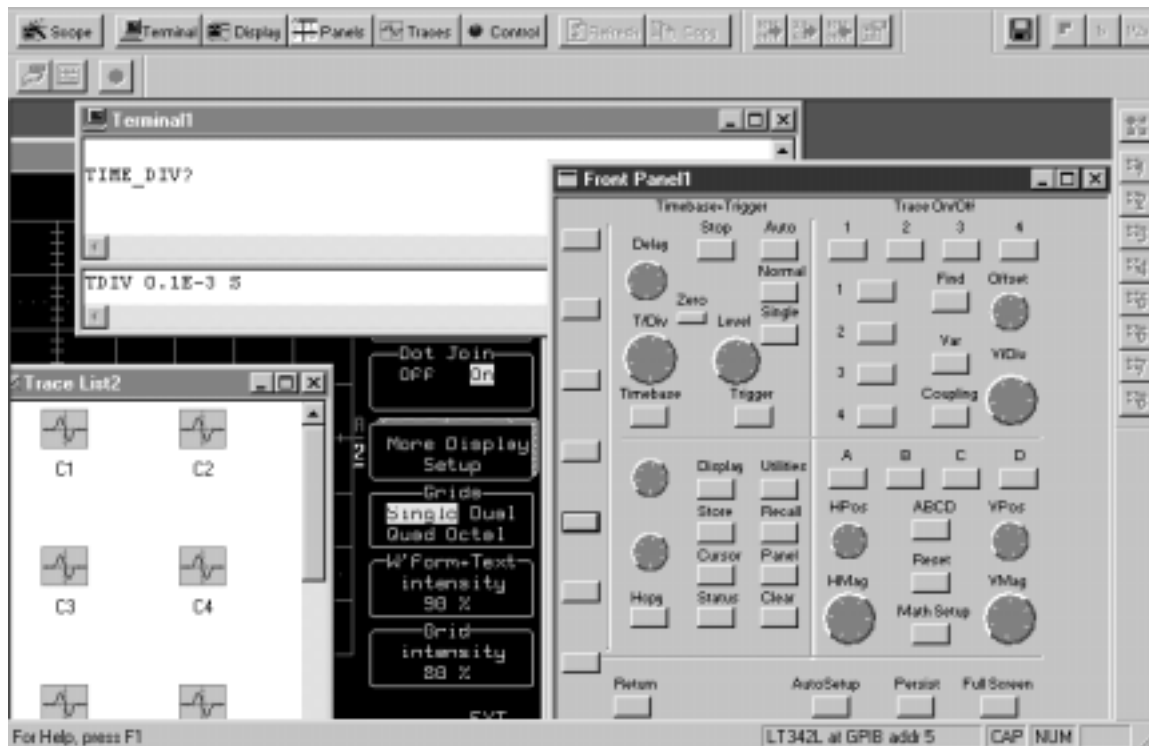

ScopeExplorer now has a virtual front panel to allow full control of remote scopes.

ActiveDSO works on any PC running Windows 95, 98 or NT™, and enables you to exchange data with a variety of Windows applications or programming languages that support the ActiveX standard, such as MS® Office, Internet Explorer, Visual Basic, Visual C++ and Visual Java. ActiveDSO hides the intricacies of programming for each of these interfaces and provides a simple and consistent interface to the controlling application. You can also visually embed ActiveDSO in any OLE automation compatible client and use it manually without programming. You could, for example, generate a report by importing scope data straight into Excel or Word, analyze your waveforms by bringing them directly into MathCad®, archive measurement results “on the fly” in a Microsoft Access® database, and automate tests using Visual Basic, Java, C++, or Excel (VBA).

Visit our website at <http://www.lecroy.com/software> to download these and other free software applications.

Safety First

OPERATE IN A SAFE ENVIRONMENT

Before installing your Waverunner, ensure that its operating environment will be maintained within these parameters:

Temperature: 5 to 40 °C (41 to 104 °F)

Humidity: ≤80% RH (non-condensing)

Altitude: ≤2000 m (6560 ft)

Operation: Indoor use only

NOTE: Waverunner has been qualified to the following EN 61010-1 category:

Protection Class I

Installation (Over voltage) Category II

Pollution Degree 2

GET TO KNOW THE WARNING SYMBOLS

Wherever these warning signs appear on the Waverunner's front or rear panels, or in this manual, they alert you to aspects of safety.



CAUTION: Refer to accompanying documents (for safety related information). See elsewhere in this manual wherever this symbol is present, as indicated in the Table of Contents.



CAUTION: Risk of Electric Shock



On (Supply)



Standby



Earth (Ground) Terminal



WARNING

Any use of the instrument in a manner not specified by the manufacturer may impair the instrument's safety protection. Waverunner has NOT been designed to make direct measurements on the human body. Never connect the Waverunner to a living person.



CAUTION

Do not exceed the maximum specified input voltage levels



Protective Conductor Terminal

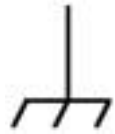

Chassis Terminal



Alternating Current Only

NOTE: Waverunner automatically adapts to the line voltage present:

115 V (90-132 V)	45-66 Hz
220 V (180-250 V)	45-66 Hz

WARNING Denotes a hazard. If a WARNING is indicated on the instrument, do not proceed until its conditions are understood and met (see also CAUTION).

CHOOSE THE CORRECT POWER SOURCE

Waverunner operates from a single-phase, 115 V (90 to 132 V) or 220 V (180 to 250 V), AC (~) power source at 45 Hz to 66 Hz.

No voltage selection is required because the instrument automatically adapts to line voltage. The power supply of the oscilloscope is protected against short circuit and overload by one 5x20 mm fuse (T 6.3 A/250 V). See next page for replacement procedure.

MAINTAIN POWER GROUND

Maintain the ground line to avoid electric shock.

The current-carrying conductors cannot exceed 250 V rms with respect to ground potential. Waverunner is provided with a three-wire electrical cord containing a three-terminal polarized plug for line voltage and safety ground connection. The plug's ground terminal is connected directly to the frame of the unit. For adequate protection against electrical hazard, this plug must be inserted into a mating outlet containing a safety ground contact. Set the power switch to STANDBY before connecting or disconnecting the power cord.

REPLACE WITH THE CORRECT FUSES

For continued fire protection at all line voltages, replace fuses only with those of the specified type and rating.

Disconnect the power cord before inspecting or replacing a fuse. Open the fuse holder (located directly to the left of the mains power plug) using a small, flat-bladed screwdriver. Remove the old fuse and replace it with a new 5x20 mm fuse (T 6.3 A/250 V).

CLEAN YOUR WAVERUNNER (BUT LET US MAINTAIN IT)

Maintenance and repairs should be carried out exclusively by a LeCroy technician.

Clean only the exterior of your Waverunner, using a damp, soft cloth. Do not use chemicals or abrasive elements. Under no circumstances allow moisture to penetrate the oscilloscope. To avoid electric shocks, disconnect the instrument from the power supply before cleaning.



CAUTION

Risk of electric shock. No user serviceable parts inside. Leave repair to qualified personnel.

Up and Running

GET TO KNOW YOUR WAVERUNNER – FRONT PANEL

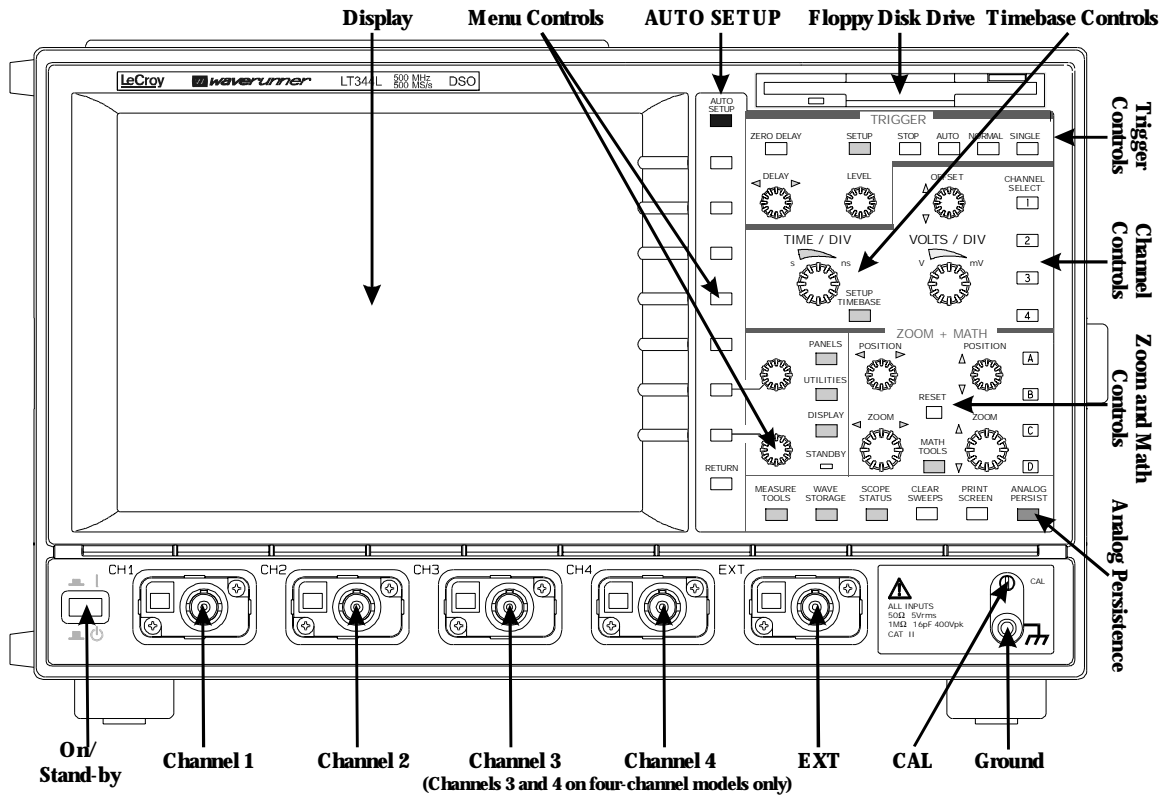

Waverunner main front panel controls and features.

INSTALL AND POWER UP

1. Before powering up, check that the local power source corresponds to Waverunner's power range (see page 7).
2. Use the cable provided to connect the scope to the power outlet through its rear panel receptacle (see next page).
3. Turn the scope on by pressing the On button at the bottom left-hand corner of the Waverunner front panel (see above).

FIRST THINGS

Before a display appears, the instrument will automatically perform hardware and software self-tests, followed by a full system calibration. The front panel STANDBY LED will be lit during this sequence. The full testing procedure will take about 10 seconds, after which a display appears.

UTILITIES

4. Press  to display the UTILITIES on-screen menus.

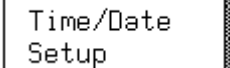
5. Then press the button beside the menu  to set the time and date.

GET TO KNOW WAVERUNNER – BACK PANEL

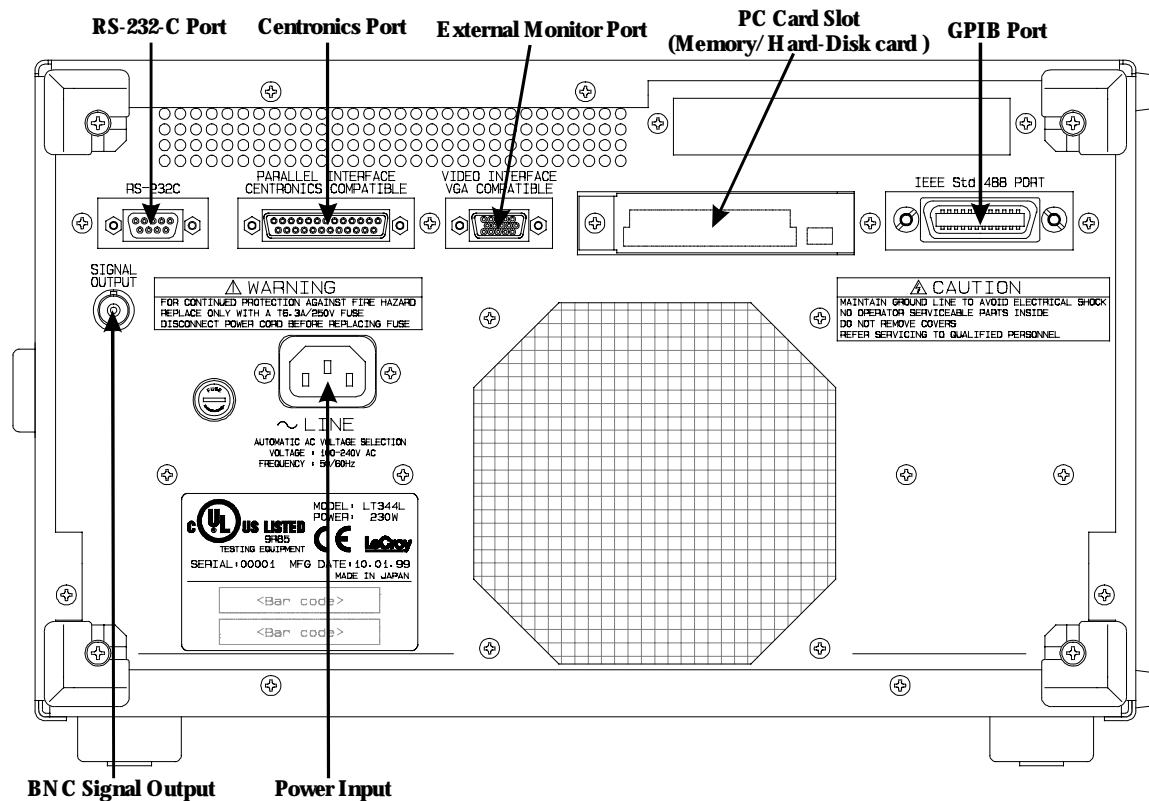

Use the RS-232-C and GPIB ports to connect your Waverunner scope to a computer or terminal, the external monitor port to display your waveforms on another monitor, and the Centronics® port to connect compatible printers or other devices. Use the PC Card slot for the PC Memory Card and portable Hard Disk options, and the BNC output for external clock signals.

TO NAVIGATE THROUGH MENUS

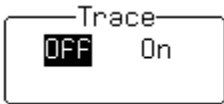

Menus such as  enable you to perform actions or adjust settings.

The menu button beside each displayed menu controls that menu.

Longer menus that span the breadth of two buttons are controlled by both buttons.

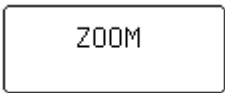
Capitalized menus —  for example — perform specific actions.

The two menu knobs work together with the two menu buttons beside them.



Combinations of knobs and buttons control continuously adjustable variables. The button selects or changes the variable, while the knob adjusts its value.

Menus are grouped and shown together according to their function. Press a button or turn a knob to select a particular menu or an item on a menu. Travel up or down in the menu list and change the selection. Or change values and settings.

The darker, labeled buttons also play a role in menu selection:  — for example — was used to select the menus for initialization. When you press any one of these, it offers access to related menus in its group.

Menus with shadows  lead to other menus: Press their buttons to display those others.

Press  **to return** to a shadowed menu. And use this button whenever you wish to go back to the previous menu display.

Arrows on the side of a long menu indicate that you can scroll up  or  down the menu list. Press one or the other of these menus' buttons to move in the desired direction, and to view or select any menu item not displayed. Arrows disappear when you reach the beginning or end of the menu list.

FIRST THINGS

INITIALIZE

Initialize your Waverunner scope to its basic default waveform display settings:

PANELS

6. Press  to display the PANEL SETUPS menu group.

7. If **Recall** is not selected, press the button once to select it:

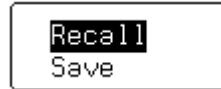

8. Then press the button beside

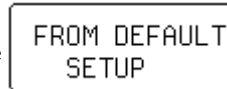

Initialize to Waverunner default settings whenever you wish to clear your settings and make a fresh start on a new measurement.

CHECK YOUR WAVERUNNER SYSTEM

SCOPE
STATUS

9. Press  to show the STATUS menus.

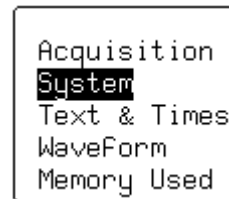

10. Press the top button to highlight and select **System**. The screen will show your Waverunner's serial number, the version of software installed and the date of its release, as well as a full list of your currently installed software and hardware.

Contact LeCroy customer service immediately if any of the options you ordered have not been installed.

ADD AN OPTION

This menu will also be displayed when you select **System:**

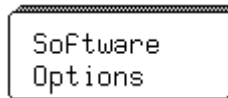

Use it to install new options — without the need to return your Waverunner for a refit.

1. Press that menu's button to display

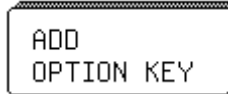

2. Then press that menu's button to display the ADD OPTION menu. Use them whenever you wish to add a Waverunner option by means of a special code. Contact your LeCroy sales or service center to obtain the code.

UPDATE TO THE LATEST FIRMWARE

Your Waverunner comes with the latest firmware installed. But to take advantage of our continuous improvement, contact us to obtain a floppy disk or card containing the latest firmware. Then use these menus to install it:

UTILITIES

1. Press  to display the UTILITIES menus.

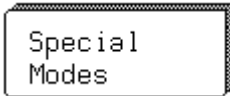
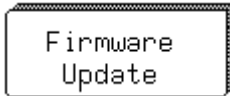
2. Press the button for , then for the one for .

3. Place the floppy or card in the Waverunner and press the buttons to select **Floppy** or **Card** and then Update Flash. The newly installed firmware will appear on the System Status screen (see above).

You may also download the firmware from the internet, using ScopeExplorer.

SAVE THE SCREEN (AND ENERGY)

Enable or disable your Waverunner's screen saver:

DISPLAY

1. Press  to show the DISPLAY SETUP menus.

2. Press the button for "More Display Setup" to access this menu:

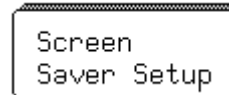

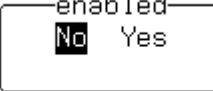
3. Press its button, then select **Yes** or **No** from 



When enabled, the built-in screen saver is activated 10 minutes after the last use of a front panel control. This is a complete display shutdown of the internal screen — an “Energy-Saver.” The front panel LED light will indicate when the scope is in the screen-saving STANDBY state. Press any front panel button to restore the screen.

DO YOU PREFER YOUR CONTROLS WITH SOUND AND AUTO-REPEAT?

Have your buttons and knobs repeat their actions and make an audible sound when used:

UTILITIES

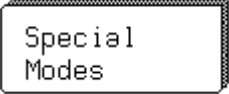
1. Press  to display the UTILITIES menus. These you will find useful for a variety of functions.

2. Press the button for , then the button for .

3. Make your preferences by means of the USER PREF'S menu displayed.

With Pushbutton auto-repeat **On**, all front panel buttons, when pressed and held in, will move the selection automatically and sequentially through all items in a menu.

With audible feedback for buttons and knobs **On**, an audible “click” will sound when any front panel button is pressed or any knob is turned.





PART ONE

GETTING STARTED

This part of the manual covers the main Waverunner features and explains, step by step, how to use them. You'll get to know your scope and start working with it quickly and effectively. Capture and view waveforms. Zoom and scroll. Learn the art of display. Use math and measurement tools. Document your work.

CHAPTER ONE: *Catch a New Wave*

In this chapter, see how

To select the input signal channel

To use menus and controls for basic operations

To find your way around the display

To adjust the timebase, gain and position of the signal

To zoom — manually and automatically

To set up the timebase

To set signal coupling

To calibrate and use the passive probe

To set up the CAL and BNC outputs

View Your Waveform

Take these steps to capture and view your signal; set time and volts per division; zoom and auto-scroll:

1. Connect your signal to the Waverunner (Channel 1 input for this example).

2. Press the blue  button to automatically set the (Edge) trigger level, timebase, and vertical settings for display of the input signal. Press it again to confirm the action.

3. Press  to select CHANNEL 1 and display the basic Waverunner menus.

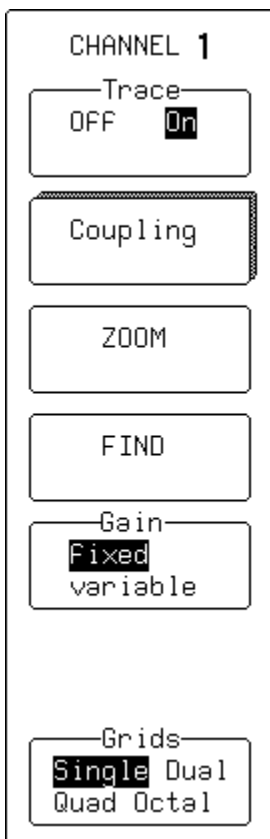



4. Use these menus in the steps on the following pages to adjust the signal's trace on the screen.

 To turn Channel 1 on or off.

TIP: Press  twice to turn the channel on or off.

 To access the CHANNEL Coupling menus. See page 24.

 To automatically make a zoomed trace of the signal. Use the vertical POSITION knob to move the trace so that it is clearly visible. Use the vertical ZOOM knob to adjust its expansion vertically. See page 22.

 To automatically set gain and offset, and “find” the signal.

 To select fixed or variable gain. Select “variable” to control the channel's gain continuously. See page 20.

TIP: With AUTO SETUP you can automatically set up signals in the 5 mV to 40 V range with a frequency of ≥ 50 Hz and a duty cycle as small as 0.1%.

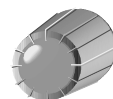

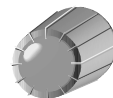

To select the grid style and number. Next page: Single grid. See also Chapter 3, “Display Your Signal.”

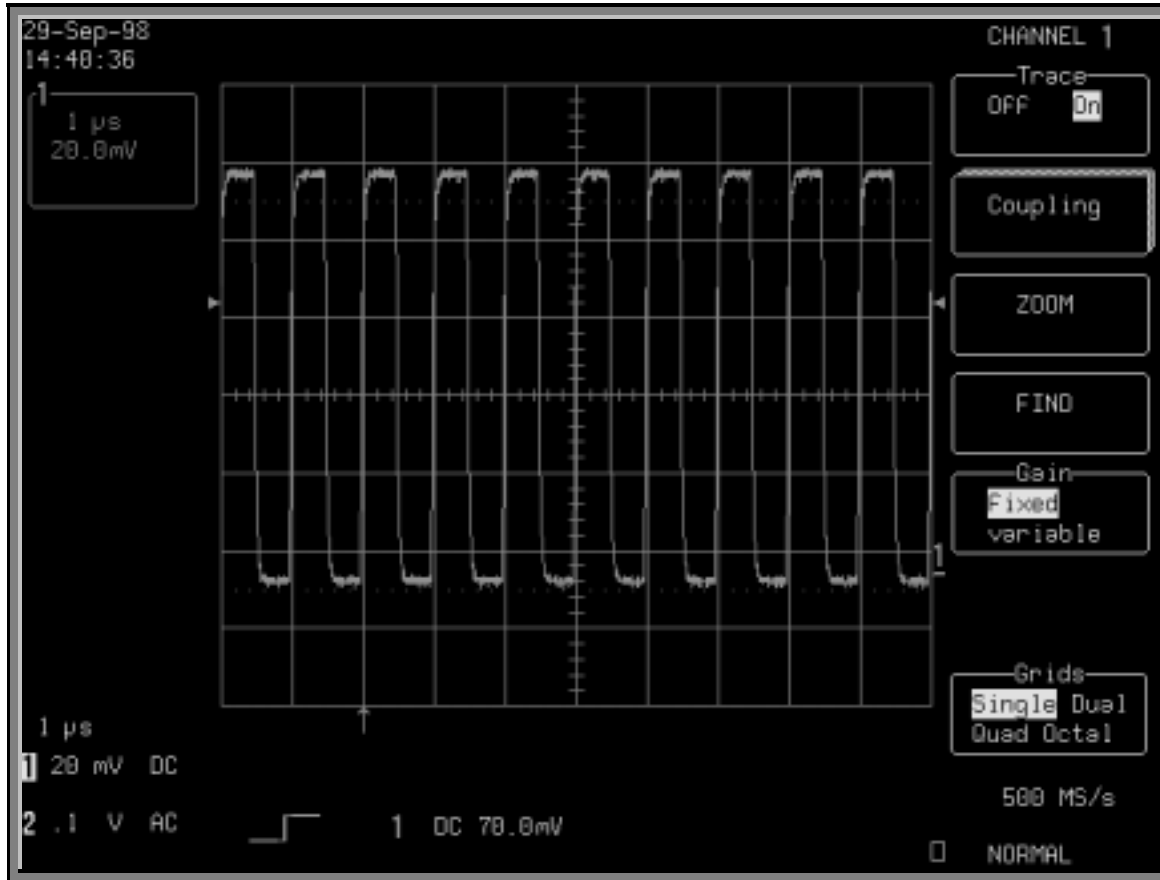

TO FIND YOUR WAY AROUND THE WAVERUNNER DISPLAY

29-Sep-98
14:40:36

Real-Time Clock field: powered by a battery-backed real-time clock, it displays the current date and time.

1
1 μs
20.0mV

Displayed Trace Label indicates each channel or channel displayed, the time/div and volts/div settings, and cursor readings where appropriate.

1 μs
1 20 mV DC
2 .1 V AC

Acquisition Summary field: timebase, volts/div, probe attenuation, and coupling for each channel, with the selected channel highlighted.





Trigger Level arrows on both sides of the grid that mark the trigger voltage level relative to ground level.



Trigger Delay is an arrow indicating the trigger time relative to the trace.



Trigger Status field shows sample rate and trigger re-arming status (AUTO, NORMAL, SINGLE, STOPPED). The small square icon flashes to indicate that an acquisition has been made.



Trigger Configuration field contains an icon indicating the type of trigger, and information on the trigger's source, slope, level and coupling, and other information when appropriate.



Trace and Ground Level shows the trace number and ground level marker.

Other display areas include the **Time and Frequency field**, located below the grid and stating time and frequency relative to cursors, and a **Message field** placed above the grid and reserved for special messages. For more about the display, see Chapter 3, "Display Your Signal."

USE TIME / DIV TO ADJUST THE TIMEBASE

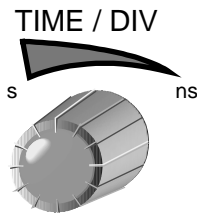

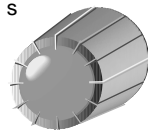
- Turn  to adjust the timebase as desired.

NOTE: AUTO SETUP operates only on channels that are turned on, unless no channels are turned on. Then all channels will be affected. When more than one channel is turned on, the first channel in numerical order with a signal applied to it will be automatically set up for edge triggering

The time per division is set in a 1–2–5 sequence. Waverunner automatically adapts itself to use the maximum sampling rate whenever the timebase is changed. The selected time/div setting is shown in the trace label at the top left portion of the screen, and the sampling rate in the trigger status field at the bottom right-hand corner.

ADJUST SENSITIVITY AND POSITION

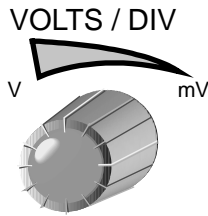

- Turn the knob to reduce the vertical gain sensitivity. The volts/div setting is shown in the Channel 1 trace label.

The next two steps can be taken (if not already) when you wish to fine tune the vertical gain and get a better vertical resolution:

- Fine tune the vertical gain by selecting "variable" from the Gain menu (see page 17).
- Now turn the VOLTS / DIV knob through several complete rotations, so that the entire signal reaches from top to bottom of the grid. Filling the grid in this way, you can use the full range of available digitizing levels.

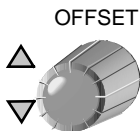

- Use the knob to center the waveform on the grid.

ZOOM AND SCROLL AUTOMATICALLY

Use ZOOM to see more detail on your signal. The display will show the original signal and its zoomed copy.

- Press the **A** button to display the TRACE A menus (to display Trace B, C, or D, press its button).
- Press the **A** button again or the top button to display the trace and its label. (Do the same to turn off a trace.)

- Press the button for:

The menus shown on the next page will be displayed.

UTILITIES

TIP: Press to select *Special Modes*. Then select the *Channels* menu to choose

In: to set the offset of a gain (VOLTS/DIV) change in volts or vertical divisions (this is in volts, by default).

Automatic Recalibration: to turn this feature on or off (default is "On"). "Off" may speed capture, but time calibration is not certain during the capture period.

Global BWL: to control the global bandwidth limit. When On, the chosen bandwidth (see page 24) applies to all channels. When Off, a bandwidth limit can be set individually for each channel.

13. Use these menus to scroll back and forth through the full length of one or all of your zoom copies.

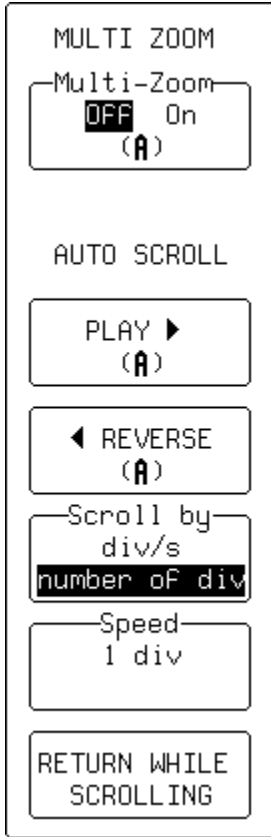

MULTI-ZOOM unifies the control of all zoom traces, while AUTO-SCROLL walks the zoom trace or traces across the referenced trace.



When **Off**, only the active zoom trace is controlled. When **On**, all displayed zoom traces (A, B, C, D) are simultaneously controlled (automatically) with Auto Scroll and (manually) with the horizontal ZOOM and POSITION knobs. See the next page for more on Multi-Zoom.



To scroll the zoom trace from right to left of screen. When playing, the menu is labeled "STOP (PLAYING)": Press to stop.



To scroll the zoom trace from left to right of screen. When playing, the menu is labeled "STOP (REVERSING)": Press to stop.



To scroll by divisions per second or number of divisions. Use **div/s** to scroll continuously for viewing. Use **number of div** for waveform processing, especially Pass/Fail testing. When processing is complete, the display will be updated by the number of divisions set.

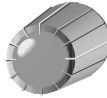

To set scroll speed, using the knob. When scrolling by divisions, 10 div will step the zoom trace "grid-page" by "grid-page" across the length of the referenced trace.

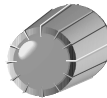

To return to the TRACE A menus, while continuing to scroll, by pressing the menu button.

RETURN



To stop scrolling and return to the previous menu displayed.

TIP: Consider zoom as an extra timebase that offers alternative sweep speeds. You can display as many as four zooms at once.



PART ONE: GETTING STARTED

USE THE POSITION AND ZOOM CONTROLS

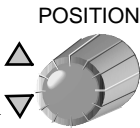
14. Turn  to place Trace A vertically on the grid.

When using more than one grid, turn  POSITION to move traces from one grid to another.

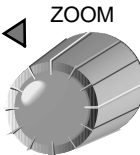
15. Turn  to adjust the expansion factor and increase the amount of zoom.

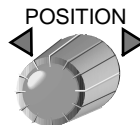
16. Turn  to move the zoomed region of the trace.

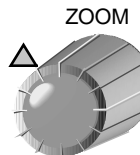
17. Turn  to vertically expand, or reduce, the zoom trace.

TIP: *The smaller Waverunner knobs are rate sensitive: the faster you rotate them, the greater the change that results per increment.*

To ZOOM AND MULTI-ZOOM

You can zoom several traces from a single waveform to obtain precise timing measurements and improve the time resolution on your displayed waveform. For instance, on a waveform composed of two pulses separated by a long delay, you could make Trace A a zoom of the first pulse, and Trace B a zoom of the second.

Multi-Zoom allows you to move the zoomed region of the waveform along two or more different traces, or two or more regions of the same trace, simultaneously. When you activate multi-zoom, the horizontal zoom and position controls apply to all displayed traces — A, B, C, and D — allowing you to view similar sections of different traces at the same time. The vertical sensitivity controls still act individually on the traces.

When trace labels have dotted top and bottom edges, like the one at right, this indicates that their traces are multi-zoomed.



SET UP THE TIMEBASE

SETUP
TIMEBASE

18. Press  and access the TIMEBASE menus.

TIMEBASE

T/div 50 μ s

250000

samples at

500 MS/s

(2 ns/pt)

For 500 μ s

Sampling

Single Shot

Sample Clock

Internal

ECL 0V TTL

Sequence

OFF On

Record up to

250k

samples

19. Use these menus to set up the timebase in single-shot mode. See Chapter 7, “A Question of Timebase,” for more on the sampling modes.



Single-Shot sampling displays data collected during successive single-shot acquisitions from the input channels — capture nonrecurring, or very low repetition-rate events, simultaneously on all input channels.



To select **Internal** or external — **ECL, 0V, TTL** — clock modes. Select internal unless using an external clock signal. See Chapter 7, “A Question of Timebase,” for external clock. The LT364 series has a “Channel Use” menu below “Sample Clock” (see “Pairing Channels” in Chapter 8).

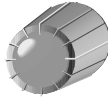

To switch sequence mode **On** or **Off**. Use the knob to choose the number of segments. See Chapter 7, “A Question of Timebase,” for sequence sampling

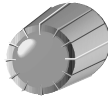

To select the maximum number of samples to be acquired, using the menu knob; and, to set the default 50k, using the menu button.

SET THE COUPLING

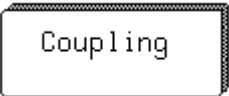
20. Press  and then the button for  to display the coupling menus.

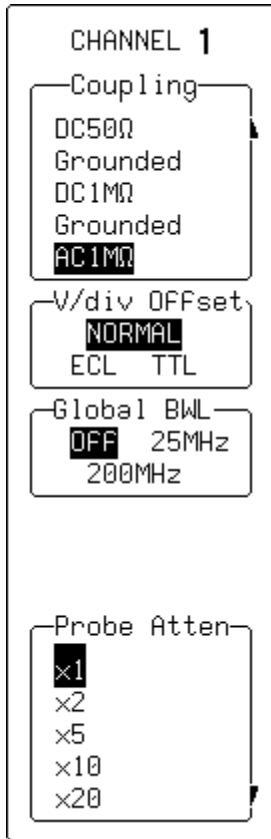

21. Use these menus to set input signal coupling and grounding, the channel bandwidth limit, and the probe attenuation.



Selects the signal coupling



Moves your selection down the list. When at the bottom, as here, the down arrow disappears and this button becomes inactive.



Press **NORMAL** to set offset, volts/div, and input coupling to display ECL signals. Press again; settings for TTL signals are given. Press a third time; settings will return to those of the last manual setup.



Press to turn the bandwidth limit **Off** or reduce the bandwidth to 200 MHz or 25 MHz. Reduces signal and system noise and prevents high-frequency aliasing. Global BWL means that the limit set will apply to all channels. BWL means that a limit can be set individually for each channel. See the TIP on page 20 for how to set these, using SPECIAL MODES.

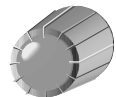

To set the probe attenuation factor for the input channel. The buttons scroll up or down, while the knobs scroll the selector up and down the list. LeCroy's ProBus® system automatically senses probes and sets their attenuation. This menu then changes to indicate the type of probe attached and its attenuation factor. See the following pages for more on probes and ProBus.

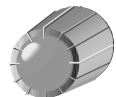

NOTE:

AC position: signals are coupled capacitively, the input signal's DC component is blocked, and signal frequencies below 10 Hz are limited.

DC position: signal frequency components are allowed to pass through, and an input impedance of either 1MΩ or 50Ω can be selected. The maximum dissipation into 50Ω is 0.5 W. Whenever this is attained, inputs will automatically be grounded. "Grounded" will be highlighted in the "Coupling" menu and an overload message will be displayed in the Acquisition Summary field. Reset by removing the signal from the input and reselecting "DC50Ω."

SETUP FOR CAL AND BNC SIGNALS

UTILITIES

1. Press  .

2. Press the button to select  and display the CAL BNC OUT menus.

CAL BNC OUT

REAR OUT

OFF

Pass/Fail

Trigger Out

Trigger Rdy

CAL OUT

SET TO 1 kHz

1 V SQUARE

Shape

Square

DC Level

Amplitude

1.00 V

into 1M Ω

Frequency

1 kHz

3. Use these menus to choose the type of signal put out at the front CAL and rear BNC signal outputs. Set the frequency, amplitude, and pulse shape of the calibration signal.



To set the type of signal from the rear BNC connector.



To reset the CAL output to its default state: a 1 kHz 1 V square wave. The Waverunner automatically sets the calibration signal to its default when switched on.



To select the form of the calibration signal.

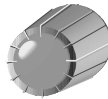

To set the pulse level for the CAL output (range: -1.00 to 1.00 V), using the knob.

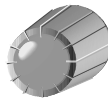

To set the desired frequency of a CAL signal in the range 500 Hz to 1 MHz, using the knob.

PART ONE: GETTING STARTED

TO CALIBRATE THE PASSIVE PROBE

Your Waverunner scope comes with a LeCroy passive probe for each channel.





First. Turn on your Waverunner scope.

Second. Insert the probe lead in the Channel 1 input.

Third. Connect the probe tip to the CAL output (see front panel illustration in “First Things”).

Fourth. Attach the lead's alligator clip to the ground ring indicated by , located below CAL.

The CAL signal will be a 1 kHz square wave, 1 V p-p.

Fifth. Press  , then the button to select 

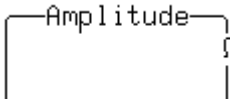
Sixth. Press  to select  and set the amplitude level.

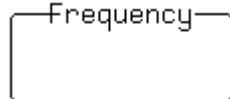
Seventh. Now select  to set the frequency in the range 500 Hz to 1 MHz.

Eighth. Set channel coupling to DC 1 M Ω using “Coupling” (see previous page).

Ninth. Press  to turn on Channel 1.

Tenth. Press  twice.

If overshoot or undershoot of the displayed signal occurs, adjust the probe by inserting the small screwdriver, supplied with the probe package, into the potentiometer on the probe head and turning it clock wise or counterclock wise to achieve the optimal square wave contour.

HOW PROBUS HELPS YOU

LeCroy's ProBus probe system provides a complete measurement solution from probe tip to oscilloscope display.



ProBus allows you to control transparent gain and offset directly from your front panel — particularly useful for voltage, differential, and current active probes. It uploads gain and offset correction factors from the ProBus EPROMS, and automatically compensates to achieve fully calibrated measurements.

This intelligent interconnection between your Waverunner scope and a wide range of accessories offers important advantages over standard BNC and probe ring connections. ProBus ensures correct input coupling by auto-sensing the probe type, eliminating the guesswork and errors that occur when attenuation or amplification factors are set manually.

TIP: Use Waverunner's rear panel BNC signal output to provide a pulse:

For Pass/Fail testing

At the occurrence of each accepted trigger event (Trigger Out)

When the scope is ready to accept a trigger event (Trigger Rdy)



CHAPTER TWO: *Simply Trigger*

In this chapter, see how

To control triggers

To set up an Edge trigger

To re-arm triggering

To determine level, coupling and slope

To use Window trigger

To obtain a summary of your trigger and system status

Edge Trigger on Simple Signals

Waverunner uses many waveform capture techniques that trigger on features and conditions, which you define. These triggers fall into two major categories:

Edge — activated by basic waveform features or conditions such as a positive or negative slope, and holdoff

SMART Trigger® — sophisticated triggers that enable you to use basic and complex conditions for triggering. See Chapter 8, “Trigger Smart.”

Use the Edge trigger type for simple signals, and the SMART Trigger type for signals with rarer features such as glitches.

CONTROL TRIGGERING

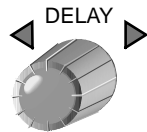

Horizontal: Turn  to adjust the trigger's horizontal position.

You can adjust the trigger's position from 0% to 100% pre-trigger, from left to right on the grid. DELAY can also be used for setting the post-trigger, in time units, up to 10 000 divisions, in increments of 0.1 division.

The trigger location is shown by the arrow at the grid bottom, as shown here at near right.

Post-trigger delay is labeled in the trigger delay field, where the arrow becomes horizontal, as shown here at far right.

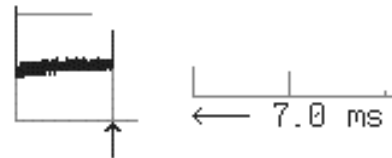

TRIGGER LEVEL

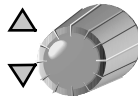

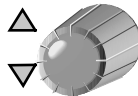
Vertical: Turn  to adjust the trigger's vertical threshold.

Turn this knob to adjust the level of the trigger source or the highlighted trace. Level defines the source voltage at which the trigger will generate an event — a change in the input signal that satisfies the trigger conditions.

Arrows on both sides of the grid show the threshold position. But these arrows are only visible if the trigger source is displayed and the source signal DC coupled.



SET UP AN EDGE TRIGGER

1. Press TRIGGER  to access these menus:

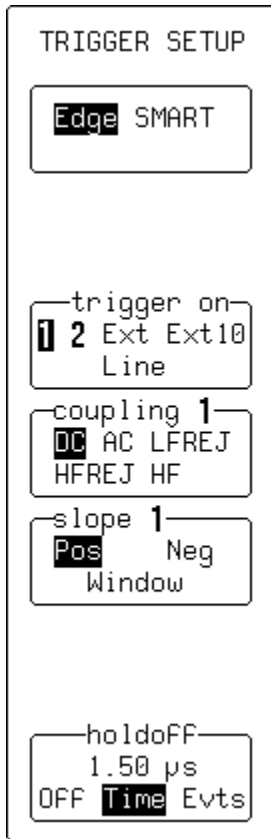

Use them to select the trigger source, the source's coupling, the slope — positive or negative — and the amount of trigger holdoff by time or events.

-  1. Select "Edge" or "SMART": "**Edge**" is selected by default.

TIP: Once set, trigger level and coupling pass unchanged from trigger type to trigger type for each trigger source.

-  2. Select the trigger source. This could be a signal on a channel, the line voltage that powers the Waverunner, or the EXT BNC connector.

-  3. Select the coupling for the trigger source.

-  4. Place the trigger point on the positive or negative slope of the selected source, or choose to define a window

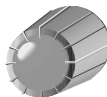
  When **Window** is selected from the above menu, a menu appears here that allows you to define the window's size. See page 33.

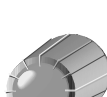
  To hold off from triggering for a defined time, or number of events, after a particular trigger event. Use this button to select **Time** or **Events**, and the knob to set the value. **Off** deactivates the holdoff. See Chapter 8, "Trigger Smart."

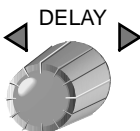
5. Turn  to adjust the trigger's horizontal position, and the amount of pre-trigger, as desired.

6. Turn  to adjust the trigger voltage level.

TO DETERMINE TRIGGER LEVEL, COUPLING AND SLOPE



Level defines the source voltage at which the trigger circuit will generate an event: a change in the input signal that satisfies the trigger conditions. The selected trigger level is associated with the chosen trigger source.

Trigger level is specified in volts and normally remains unchanged when you change the vertical gain or offset. The amplitude and range of the trigger level are limited as follows:

- ± 5 screen divisions with a channel as the trigger source
- ± 0.5 V with EXT as the trigger source
- ± 5 V with EXT/ 10 as the trigger source
- None with LINE as the trigger source (zero crossing is used).

Coupling refers to the type of signal coupling at the input of the trigger circuit. As with the trigger level, you can select the coupling independently for each source. Change the trigger source and you can change the coupling. You can choose from these coupling types:

DC: All the signal's frequency components are coupled to the trigger circuit for high frequency bursts or where the use of AC coupling would shift the effective trigger level.

AC: The signal is capacitively coupled, DC levels are rejected and frequencies below 50 Hz attenuated.

LF REJ: The signal is coupled through a capacitive high-pass filter network, DC is rejected and signal frequencies below 50 kHz are attenuated. For stable triggering on medium to high frequency signals.

HF REJ: Signals are DC coupled to the trigger circuit, and a low-pass filter network attenuates frequencies above 50 kHz; used for triggering on low frequencies.

HF: Use only when needed for triggering on high-frequency repetitive signals. HF is automatically overridden and set to AC when incompatible with trigger characteristics such as those of SMART Trigger.

Slope determines the direction of the trigger voltage transition used for generating a particular trigger event. You can choose a positive or negative slope. Like coupling, the selected slope is associated with the chosen trigger source.

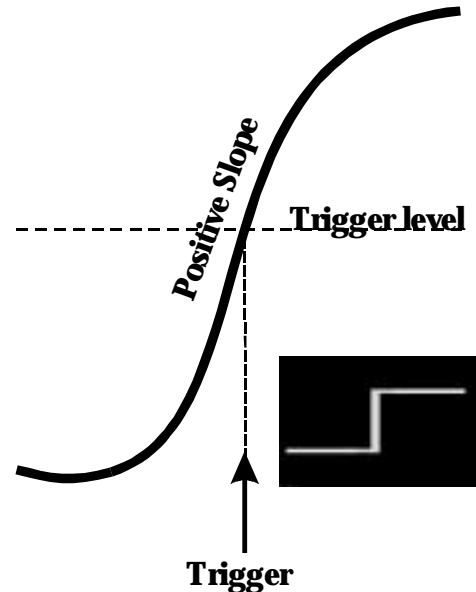

Figure 1. Edge trigger works on the selected edge at the chosen level. The slope — positive here — is highlighted on the trigger icon.

PART ONE: GETTING STARTED

TO RE-ARM A TRIGGER

Three trigger re-arming modes — *AUTO*, *NORMAL*, and *SINGLE* — are available for all types of triggers. In addition, *STOP* cancels the capture in all three modes.



AUTO

Press  to activate *AUTO* mode: the trace will automatically be displayed if no trigger occurs soon after. But if a signal does occur, Waverunner behaves as if in *NORMAL* mode.

NORMAL

Press  to enter *NORMAL* mode and continuously update the display while there is a valid trigger. If there is no valid trigger, the last signal is retained and the warning "*SLOW TRIGGER*" is displayed in the trigger status field.

SINGLE

Press  to enter *SINGLE* mode: the Waverunner will wait for a single trigger to occur, then display the signal and stop capturing. If no trigger occurs, you can press this button again to manually trigger the scope.

STOP

Press  to halt the capture made in *AUTO*, *NORMAL* or *SINGLE* re-arming modes. Press *STOP* to prevent capture of a new signal, or while a single-shot capture is under way to keep the last captured signal.

TO RECOGNIZE TRIGGER ICONS

Trigger icons allow immediate on-screen recognition of the current trigger conditions. There is an icon for each trigger. The more heavily marked transitions on the icon indicate the slope on which the trigger will be generated. The icons are annotated with information on the trigger settings.

This icon, for example, represents an *Edge* trigger set up to trigger on the positive slope, at a level of 0.008 V, with a holdoff time of 50 ns.

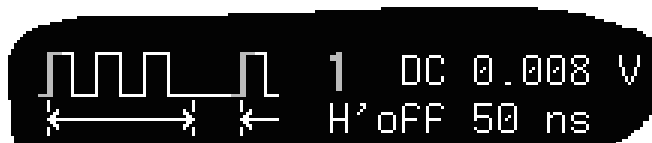

USE WINDOW TRIGGER

Define a region whose boundaries extend above and below the selected trigger level. A trigger event will occur when the signal leaves this window region in either direction and passes into the upper or lower region (Fig. 2). The next trigger will occur when the signal again passes into the window region.

1. Select

slope 1
Pos Neg
Window

.
2. Then use

window size
+ - 67.0mV
around level

 to define the size of the window region.

A bar at the left-hand side of the grid will visually indicate the window's height.

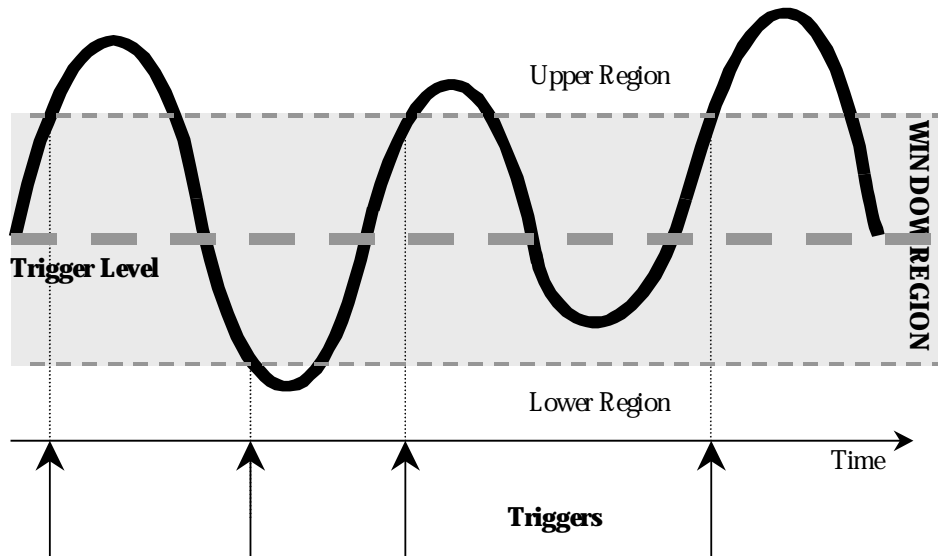

Figure 2. Window Trigger: triggers when the signal leaves the window region. The arrows indicate where triggers occur when the signal leaves the window region.

TRIGGER SOURCE

The trigger source may be one of the following:

The acquisition channel signal (CH 1, CH 2, CH 3 or CH 4) conditioned for the overall voltage gain, coupling, and bandwidth.

The line voltage that powers the oscilloscope (LINE). This can be used to provide a stable display of signals synchronous with the power line. Coupling and level are not relevant for this selection.

The signal applied to the EXT BNC connector (EXT). This can be used to trigger the oscilloscope within a range of ± 0.5 V on EXT and ± 5 V with EXT/10 as the trigger source.

Level

Level defines the source voltage at which the trigger circuit will generate an event (a change in the input signal that satisfies the trigger conditions). The selected trigger level is associated with the chosen trigger source. Note that the trigger level is specified in volts and normally remains unchanged when the vertical gain or offset is modified.

The Amplitude and Range of the trigger level are limited as follows:

± 5 screen divisions with a channel as the trigger source

± 5 V with EXT/10

none with LINE as the trigger source (zero crossing is used)

Note: Once specified, Trigger Level and Coupling are the only parameters that pass unchanged from trigger mode to trigger mode for each trigger source.

OBTAIN A TRIGGER STATUS SUMMARY

Display a summary of the status of your trigger, as well as timebase, vertical sensitivity, probe attenuation, and offset and coupling for each channel.

1. Press  to show the STATUS menus.
2. Press the button to select **Acquisition**.

PRINT SCREEN

TIP: Press  to document your status summary and make a hard copy.

PANELS

Press  when you have a setting you want to reuse (see the next chapter for more on this).

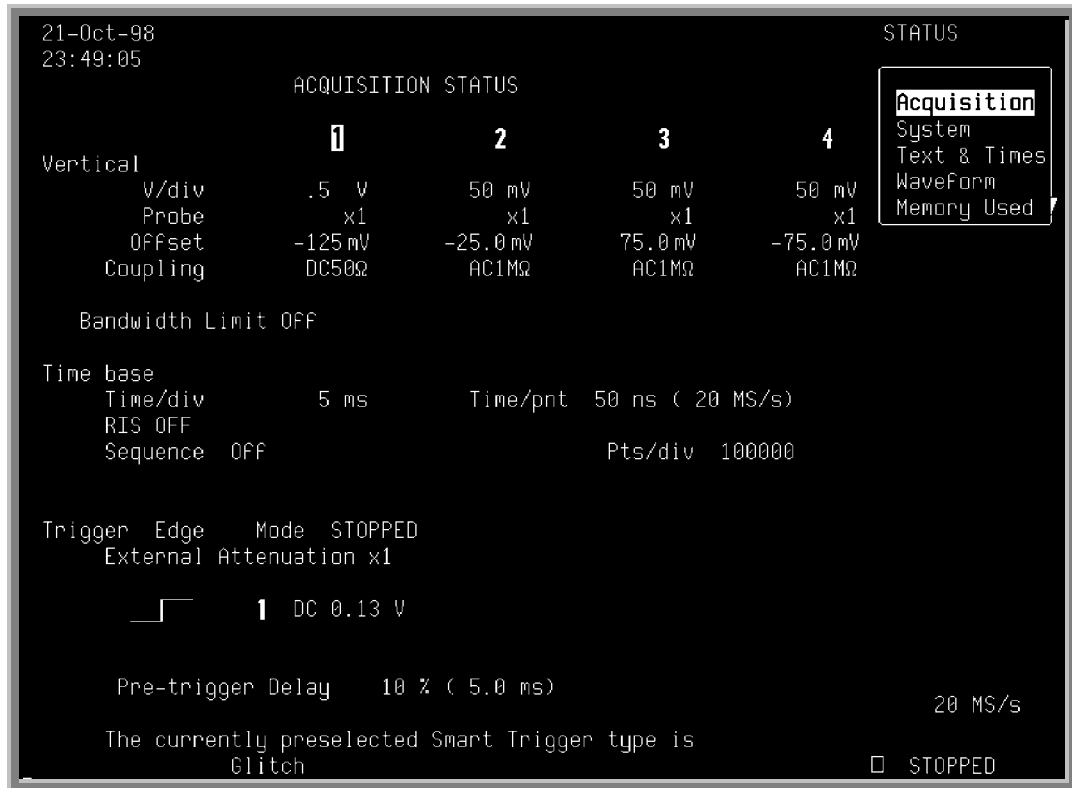

Press the *SCOPE STATUS* button for access to full-screen summaries of your Waverunner's system status and other functional status.

See Chapter 8, "Trigger Smart," for more about Edge trigger and all about the SMART Trigger types.



CHAPTER THREE: *Display Your Signal*

In this chapter, see how

To view signal changes over time

To set up the display

To set up for Analog Persistence™

To choose a grid style

To save and recall panel setups

Display Persistence

You can use Waverunner colors and tools to display your signal on the screen.

View one, two, four, or eight grids and up to eight traces (depending on model) at the same time. Adjust display and grid intensity. Choose from several grid styles. Or fill the entire screen with your waveforms using Full Screen.

You can personalize your Waverunner display, while managing color and screen intensity automatically. The displayed signal and all related information share identifying colors chosen by you. Show signals and traces opaquely or transparently, so that overlapping objects — traces over traces, traces over grids — are always visible.

Other invaluable tools and techniques, such as the Analog Persistence feature, help you display your waveform and reveal its idiosyncrasies.



TIP: To clear your settings and make a “fresh” start on a new waveform:

1. **Connect the signal to be measured to a Waverunner channel.**
 2. **Simultaneously press the second and fifth menu buttons from the top, and the CHANNEL SELECT 1 button, to revert to the default settings.**
 3. **Turn off any unwanted traces by pressing A, B, C, or D.**
 4. **Press SELECT 1, 2, 3, or 4 for the signal's channel and choose “Coupling.” Ensure that the coupling matches the circuit's impedance. If not, set it correctly using the menu button.**
 5. **Press AUTO SETUP twice.**
- Then follow the steps below.**

VIEW SIGNAL CHANGES OVER TIME

Use Persistence to accumulate on-screen points from many acquisitions and see your signal change over time. Waverunner persistence modes show the most frequent signal path “three-dimensionally” in intensities of the same color, or graded in a spectrum of colors.

To display your waveform with persistence:



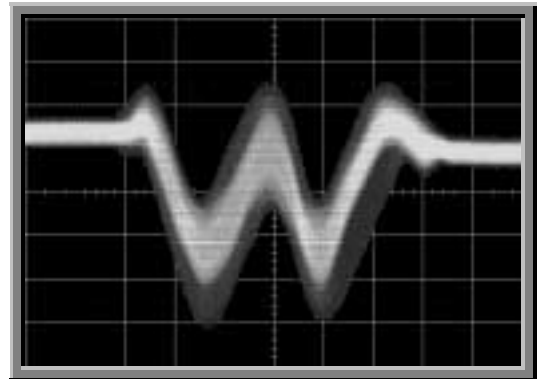



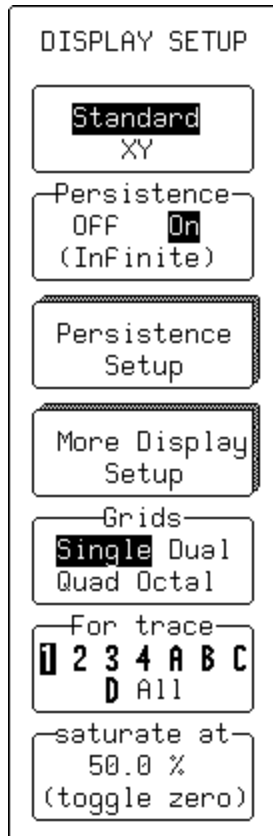

1. Press  to display your signal with Analog Persistence or Color Graded persistence.
2. Press  to display the “Display Setup” menus.



SET UP YOUR DISPLAY

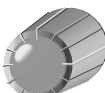

3. Use these menus to set up your display. When *not* using persistence, some menus are different, as indicated below

-  To select standard or XY display: **Standard** is selected by default. See Chapter 9, "Display More," for XY display.
-  To turn persistence on or off. Or press  to toggle it on or off.
-  To set up the persistence display (see next page). When Persistence is **Off**, this menu becomes Dot Join: when there are more than 400 sample points on the screen, the points are connected by line segments.
-  To access more display setup menus. See Chapter 9, "Display More."
-  To select the grid style and number. See page 40.
-   Used with persistence to select the displayed trace for the menu action below. When persistence is not being used, this menu is called **Wform + Text** and its knob adjusts waveform and text brightness.
-   Used with persistence to select the percentage of saturation: 100% spreads the spectrum across the entire depth of the persistence data map; at lower values, the spectrum will saturate — brightest color or shade — at the percentage value specified. Lowering this percentage causes the pixels to be saturated at a lower data intensity, and makes visible rarely hit pixels not seen at higher percentages.

TIP: At 0% intensity in Standard display without persistence, the waveform and text disappear:

Press  to return them to normal brightness.

When persistence is not being used, this menu is called Grid intensity; its knob adjusts the intensity of the grid. Grids can be brightened, or blended with displayed traces by reducing their intensity. Also press this menu button to return brightness from 0% to the default level.

SET UP FOR PERSISTENCE

4. Press the button for “Persistence Setup” to access these menus.



5. Use them to set up your persistence display.



To display **(On)** the last trace captured.



To select the persistence duration, in seconds. If this were to be set at 1 s, for example, each captured trace would be displayed for one second and then deleted. The number of sweeps included in the display (up to one million) is indicated at the bottom of the displayed trace label. The default selection is **Infinite**.



To select persistence for all, or the top two labeled traces displayed. This becomes useful when four traces or functions are shown and persistence will not be applied to all of them.



To select **Analog**, and render the persistence data maps to the screen in intensities of the trace color, or **Color Graded**, where the maps are rendered in a red-to-violet spectrum.

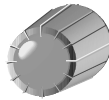

To select the displayed trace for the menu action below

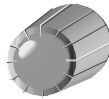

To select the percentage of saturation. See menu explanation on the previous page.

RETURN



6. Press to go back to the main display setup menus.

CLEAR SWEEPS

TIP: Press to restart the persistence accumulation of points — for example, when you change the signal source and want to clear the previous trace.



CHOOSE A GRID STYLE

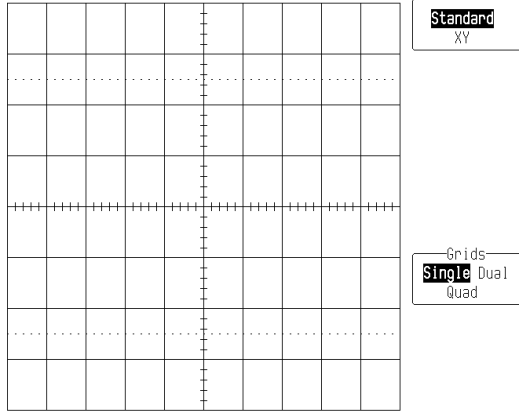

At left are the **Standard** grid styles for one, two, and four grids. Depending on the Waverunner model, six or eight traces on six or eight grids can be shown at once (see facing page), with their trace labels and any combination of math, zoom, and memories. Standard grids present source waveforms versus time (for FFT, versus frequency). **XY** display, on the other hand, compares one source waveform with another. It has its own special grids (see Chapter 9, “Display More”). The **Parameter**-style grid is displayed automatically when parameters are used (see next chapter).

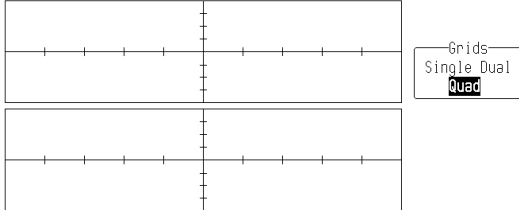
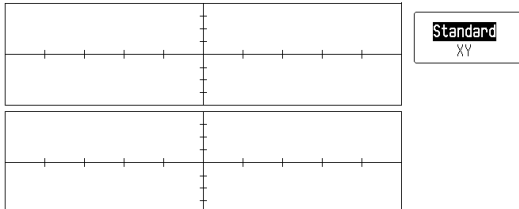
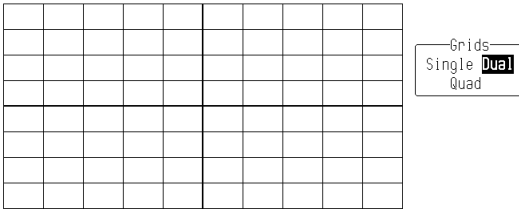
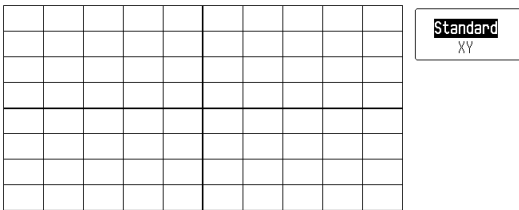

TO LINK AND SEPARATE OBJECTS WITH COLOR



Advanced color management ensures that objects — grids, waveforms, cursors, or text — are always visible, even when overlapping. Signals and their related data are color associated. Each trace has its own dedicated color. Persistence displays are automatically color matched to the parent trace. Related traces and text, icons and parent-daughter zoom regions are also linked by color.

The choice of background color is limited to the darker colors so that displayed objects will be clearly defined and recognizable. The colors of objects that are too close in hue to the chosen background color are automatically changed so that the objects always stand out.

Each trace has its own color. But expanded or zoomed sections of a trace can be given their own colors, so that a single trace may have a number of colors at once: its principal color plus those of a number of expanded regions.

Trace-related text includes pieces of on-screen information that describe measurement parameters, cursors, triggers, waveforms, and channels. A standard text color covering all on-screen text exists in the preset color schemes, or can be chosen for custom palettes. See Chapter 9, “Display More.”



Waveform source descriptions, trace labels and the information they contain will always take the color of their respective traces, as in this four-channel model's Octal-grid, eight-trace display.

Most menus are displayed in the text color only. The active trigger edge or condition shows source related information in the trace color, as does the trigger icon. Channel Coupling menu titles are trace colored, and Math Set-Up menu sources have their own color.

Select **Opaque** to place overlapping waveforms one on top of the other in normal, non-transparent layers. Select **Transparent** for overlap mixing: those areas of the waveforms that overlap will automatically change color, while grid intensity remains constant. See Chapter 9, "Display More."

Objects are automatically overlaid in sequence. With traces of the same type, the foremost is described in the top trace label, the next in the second-from-top trace label, and so on in descending order toward the background. Choose the order in which traces appear using the **SELECT** buttons. When different types of traces are displayed, placed by default in ascending order from the grid at the bottom are: envelope traces, persistence traces, normal traces, and cursors (foremost on the screen). This sequence can also be customized.

Save and Recall Your Panel Setups

Your Waverunner scope allows you to store your preferred display settings and recall them later. Or choose to recall a default setup already installed in the scope. Storing and recalling panel setups is very practical when you have set up elaborate zoom and math displays on multiple traces and would like to use them on another signal. The scope can store four panel setups in volatile memory, and many more to floppy disk or the optional PC Card slot (memory card or hard disk card), in numbered files marked with their date and time of storage. You can recall them quickly and easily for later use.

SAVE PANEL SETUPS

PANELS

1. Press  for the PANEL SETUPS menus.



Use these menus to save your preferred panel setups — to SETUP1 in this example.



2. Press to select **Save**.



3. Press to save to SETUP1.



To save to SETUP2.



To save to SETUP3.



To save to SETUP4.

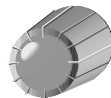

To save to PC Card slot.

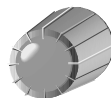

To save to floppy disk.

RECALL PANEL SETUPS

1. Press  to .

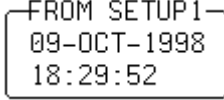
2. Press  to select  and recall the setup you stored for example in SETUP 1.

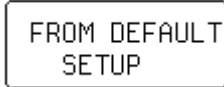
Or, to recall a default setup already stored in your scope, press the button to select .

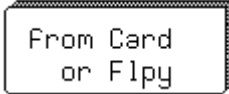
Or, when you store setups to floppy disk or PC Card, press the button to select .

The last alternative accesses the RECALL SETUPS menu, which enables you to recall setups from a floppy disk in the floppy disk drive, or an optional portable storage device (PC memory card or hard disk card) in the PC Card slot.

To store and recall the waveforms themselves, see Chapter 5, “Use Math Tools.”



CHAPTER FOUR: *Choose a Measure Tool*

In this chapter, see how

To control time cursors

To control amplitude cursors

To use cursors in standard display

To select a standard parameter

Measure with Cursors

Cursors are important tools that aid you in measuring signal values. Cursors are markers — lines, cross-hairs, or arrows — that you can move around the grid or the waveform itself. Use cursors to make fast, accurate measurements and to eliminate guesswork. There are two basic types:

Time (Frequency) cursors are markers that you move horizontally along the waveform. Place them at a desired location along the time axis to read the signal's amplitude at the selected time.

Amplitude (Voltage) cursors are lines that you move vertically on the grid to measure the amplitude of a signal.

CONTROL THE TIME CURSORS

1. Press  and make sure that **Standard** is selected in the top menu.

2. Press  to display the MEASURE menus.

3. Press the button to select

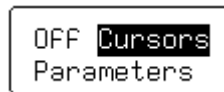

4. Press the button to select

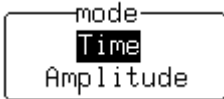

5. Press the button to select

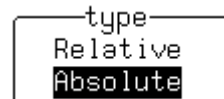



SINGLE

TIP: Press  as a smooth way to stop your Waverunner scope and allow measurement of the displayed waveform.

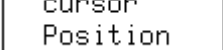

PART ONE: GETTING STARTED

6. Turn the knob for  to move the Absolute Time cursor .

Watch this cross-hair marker move up and down along your displayed waveform. As it moves, the cursor's time value in relation to the trigger point is shown beneath the grid, and its voltage value in the trace label.

7. Press the button to select

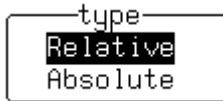

TIP: Select "Diff & Ref" from the show menu to display in the trace label the absolute amplitude, with respect to ground level, of the two Relative Time cursors.

8. Turn the knobs to move the two Relative Time cursors   along the waveform.

Waverunner shows beneath the grid the relative time and voltage difference between the two cursors. When you use Relative Time cursors, the Reference cursor (upward-pointing arrow) can be changed, and could be different from the trigger point. You might place it, for example, at the falling edge of the captured signal's oscillations. You can move the Difference cursor (downward-pointing arrow) to measure the time difference anywhere on the waveform. **Diff – Ref** shows the subtraction of the reference from the difference amplitudes.

CONTROL THE AMPLITUDE CURSORS

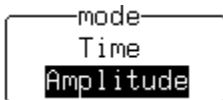

1. Press the button to select



2. Press the button to select



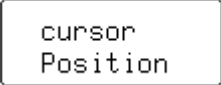

TIP: Turn Track "On" in the Reference Cursor menu. The difference between the Reference and Difference cursors will remain the same when you turn this menu's knob, and the two cursor bars will move in tandem. Turn the Difference cursor menu knob: only this cursor's position will change. The link between the two cursors is indicated by a vertical bar at the side of the grid. Press the same menu button to turn Track "Off".

3. Turn the knob for  to move the Absolute Amplitude cursor .

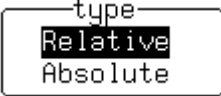
Place it at the top of your displayed waveform. The difference in amplitude between the cursor and the ground level (indicated by the ground level marker at right of grid) is shown in the trace label.

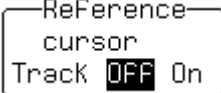
4. Press the button to select  and show two bar cursors: Reference and Difference.

5. Turn the knob for  to move the Reference  cursor

6. Turn the knob for  to move the Difference cursor

When you use Relative Amplitude cursors, the Reference cursor can be made different from the ground level. You might place it, for example, at the base level of a square wave. You could then position the Difference cursor at the top of the waveform. The difference between the two would then give you the signal's amplitude, indicated in the trace label, as illustrated on the next page.

PART ONE: GETTING STARTED

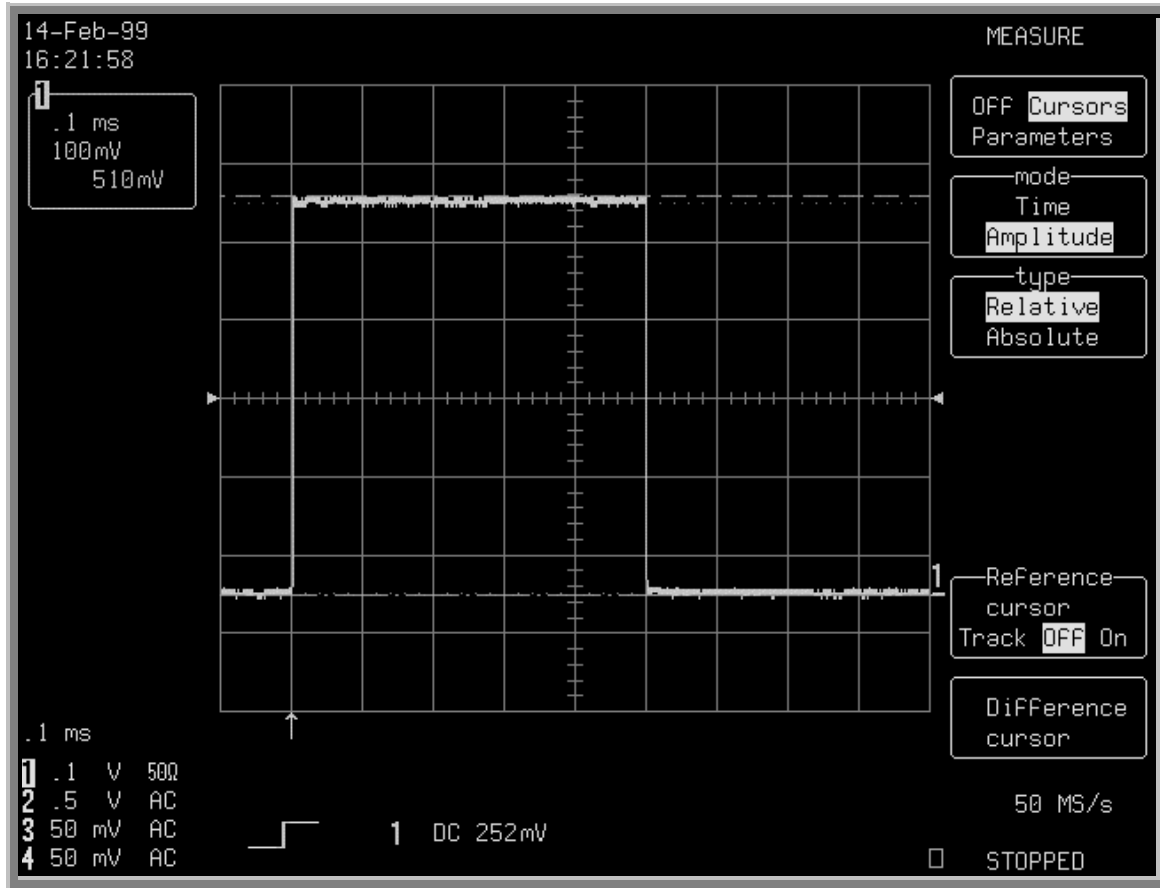

Relative Amplitude cursors mark out the signal's amplitude. Here it is 510 mV, as indicated in the trace label at top-left of screen.

TO USE CURSORS IN STANDARD DISPLAY



You can move **Amplitude** (Voltage) cursors — broken lines or bars running across the screen — up and down the grid pixel by pixel. Amplitudes are shown in the trace label for each trace.

Place **Time** (Frequency) cursors — arrows or cross-hair markers that move along the waveform — at a desired time to read the amplitude of a signal at that time, and move them to every single point acquired.

When you place a time cursor on a data point, cross-bars appear on the arrow and cross-hair markers \updownarrow \downarrow \uparrow .

The time is shown below the grid. In Relative mode the frequency corresponding to the time interval between the cursors is also displayed there. When there are few data points displayed, time-cursor positions are linearly interpolated between the data points. Time cursors move up and down along these straight-line segments.

In **Absolute** mode, you control a single cursor. You can display the cursor location's readings for amplitude (using amplitude cursors) or time and amplitude (using time cursors). Measured voltage amplitudes are relative to ground; measured times are relative to the trigger point.

In **Relative** mode, you control a pair of amplitude or time cursors, and get readings on the difference between the two in amplitude, or time and amplitude.

WHEN IN PERSISTENCE MODE

In persistence mode, amplitude cursors are the same as in Standard display, while time cursors are vertical bars running down the screen and moving across it.

TIP: To set time-cursor amplitude units in volts or decibels...

UTILITIES

Press  to access and select Special Modes. Then select the Cursors Measure menu to access and use the Read time cursor amplitudes in menu to select the desired unit.



Measure Automatically with Parameters

Parameters are measurement tools that determine a wide range of signal properties. Use them to automatically calculate time and voltage values. There are parameter modes for the amplitude and time domains, custom parameter groups, and parameters for pass and fail testing. You can make common measurements on one signal in either the standard voltage (amplitude) or standard time modes. On more than one signal, select parameters from a Custom category and use them to determine up to five quantities at once. Pass and fail parameters can be customized, too. You can accumulate and display statistics on each parameter's sweeps, average, lowest, highest and standard deviation. See Chapter 11, "Parameter Analysis," for how to customize parameters, and for a description of each.

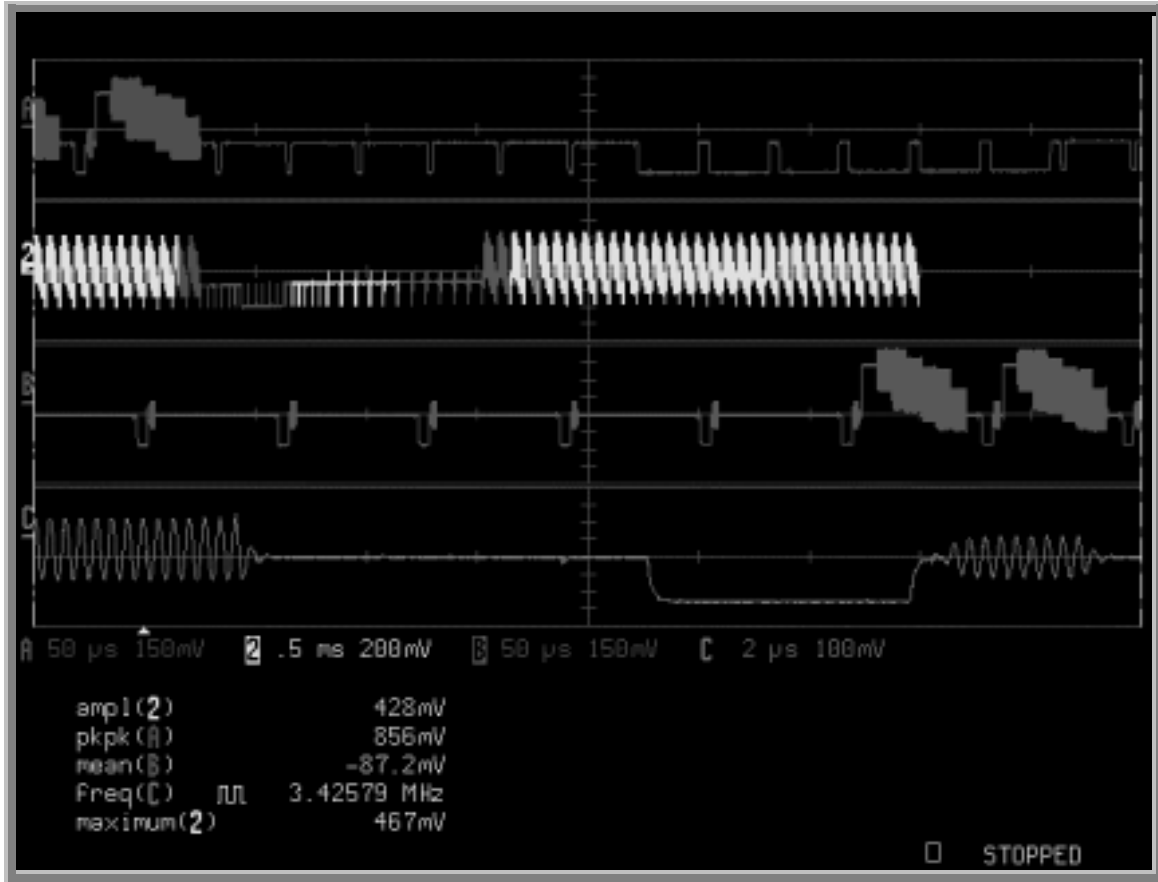

A special display is automatically used with parameters, whose data are listed beneath the grid (see next page for display setup). Shown here: a Full-Screen, Quad-grid parameter display. Top of facing page: the Standard, Single-grid, parameter display.

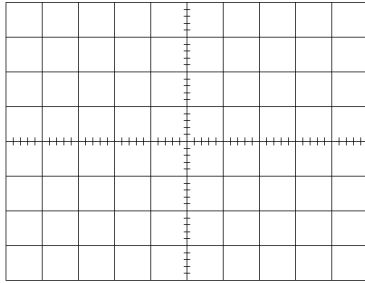

CHOOSE A STANDARD PARAMETER

MEASURE
TOOLS

1. Press  to display the MEASURE menus.



2. Press the button to select

pkpk (1)
mean (1)
sdev (1)
rms (1)
ampl (1)

Standard Voltage will be selected by default in the mode menu, shown below, and a list of five parameters will appear beneath the grid. This list will change when **Standard Time** is selected.

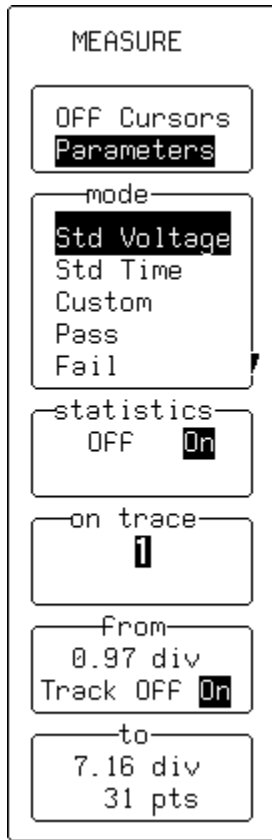

3. Use these menus to set up for parameters.



To enable parameters, cursors or neither. While **Parameters** is selected, statistics accumulation (see below) goes on, even if not shown.



To select the mode. **Standard Voltage** measures for a single signal: peak-to-peak (the amplitude between the maximum and minimum sample values), mean of all sample values, standard deviation, root mean square of all sample values, and signal amplitude. **Standard Time** measures for a single signal: period, width at 50% of amplitude, rise time at 10–90% of amplitude, fall time at 90–10% of amplitude, and the delay from the first trigger to the first 50% amplitude point. See Chapter 11 for “Custom,” “Pass,” and “Fail.”



To automatically calculate the displayed parameters’ average, lowest, highest and standard deviation, and number of sweeps used.



To select the trace on which the parameters are to be measured. This menu indicates those traces displayed.

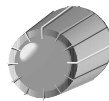

To set the starting point in screen divisions for parameter measurements, using the knob. Turn Track **On**, using the button. Control of the starting and end points is linked and they can be moved together using the knob.

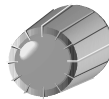

To set the end point in screen divisions for parameter measurements, using the knob. Also indicates the total number of data points used for the measurements.

PART ONE: GETTING STARTED

DISPLAY

4. Press  to set up the display — to select parameter grid styles, for example — using DISPLAY SETUP. See the preceding chapter.

TURN OFF CURSORS AND PARAMETERS

MEASURE
TOOLS

1. Press  to return to the MEASURE menus.

2. Press the button to select 



TO RECOGNIZE PARAMETER SYMBOLS

The algorithms that allow Waverunner to determine pulse-waveform parameters detect the particular situations where the mathematical formulas can be applied.



Sometimes you should interpret the results with caution. In these cases the scope alerts you by displaying a symbol under the grid between the name of the parameter and its value. These symbols act as information or warnings:



The parameter has been determined for several periods (up to 100), and the average of those values has been taken.



The parameter has been determined over an integral number of periods.



The parameter has been calculated on a histogram.



Insufficient data to determine the parameter.



A amplitude histogram is flat within statistical fluctuations; minimum and maximum are used to assign top and base.



Only an upper limit could be estimated (the actual value of the parameter may be smaller than the displayed value).



The signal is partially in overflow.



The signal is partially in underflow.



The signal is partially in overflow and in underflow.



CHAPTER FIVE: *Use Math Tools*

In this chapter, see how

To set up for math

To do multiplication

To perform an FFT

To do summed averaging

To store and recall waveforms

To obtain a waveform or memory status report

Make Math Easy

With Waverunner math tools you can perform mathematical functions on a waveform displayed on any channel, or recalled from any of the four reference memories M1, M2, M3, or M4. To do computations in sequence, you can also set up any trace of A, B, C, or D for math.

For example: you could set up Trace A as the difference between Channels 1 and 2, Trace B as the average of A, and Trace C as the integral of B. You could then display the integral of the averaged difference between Channels 1 and 2. Any trace and function can be chained to another trace and function. For example, you could make Trace A an average of Channel 1, Trace B an FFT of A, and Trace C a zoom of B.





Waverunner math tools are available in these standard and optional packages:

STANDARD MATH <i>Included with all Waverunner oscilloscopes</i>	Arithmetic	Sum (add), Difference (subtract), Product (multiply), Ratio (divide)
	Averaging	Summed (linear) Average of up to 1000 sweeps
	Extrema (envelope)	
	FFT	Fast Fourier Transform to 50 000 points; Power Spectrum, Phase, Magnitude; All FFT Windows
	Functions	Identity, Negation, (Sin x)/x
	Resample (deskew)	
	Rescale	
	Enhanced Resolution (ERES)	
EXTENDED MATH AND MEASUREMENT OPTION (EMM) <i>All tools in Standard Math plus:</i>	Functions	Absolute Value, Derivative, Exp (base e), Exp (base 10), Integral, Log (base e), Log (base 10), Ratio, Reciprocal, Square, Square Root
	Trending	
WAVE ANALYZER OPTION (WAVA) <i>All tools in Extended Math plus:</i>	Averaging	Summed, or linear, Average of up to one million waveforms; Continuous Average
	FFT+	Fast Fourier Transform to one million points; FFT Average; Power Averaging, Power Density, Real, Real + Imaginary
	Histograms	Histograms, Histogram Parameters

PART ONE: GETTING STARTED

SET UP TO DO WAVEFORM MATHEMATICS

After connecting your signal to a Waverunner channel (Channel 1 in this example), do the following:

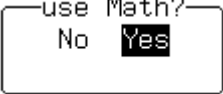
1. Press  to select CHANNEL 1 and display Waverunner's basic menus.
2. Press  to .
3. Press  to make Trace A a zoom of Channel 1.
4. Press the button for .
5. Press the button to select  and display the SETUP OF A menus, shown next page.

TO SET UP FOR MATH ANOTHER WAY

First. Press  to display the ZOOM + MATH menus.

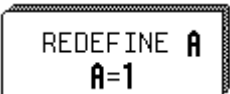
Second. Select  or one of the other traces.

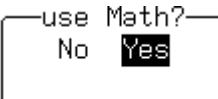
Third. Press the button to select .

Fourth. Follow the first three steps in the procedure above.



NOTE: A waveform processing title for each displayed trace will be shown in its trace label. If the title is missing, the math function cannot be done and the contents of the trace will remain unchanged.

USE A MATH TOOL

Use these menus to choose and set up any math tool. As an example, select the arithmetic tool Product to multiply Channel 1 by Channel 2.

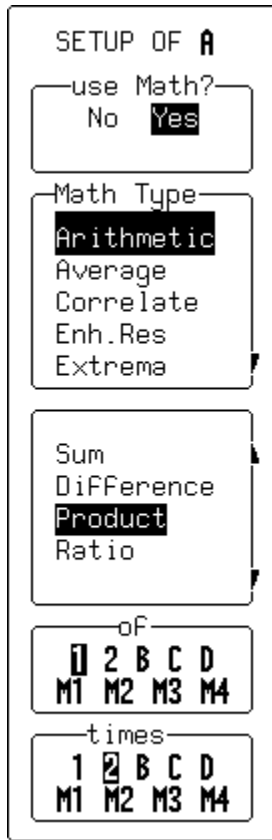

To enable math.



6. Press to select **Arithmetic**.



7. Press to select **Product**.

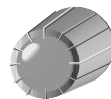

8. Press to select Channel 1 as the source trace. When using Arithmetic, this sets one of the two operand sources. Using other math types, this menu may be in a different position and may set the signal offset, number of sweeps, or compensate for any DC offset in the signal.

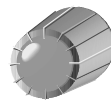

9. Press to select the trace by which the source trace Channel 1 will be multiplied.

Now go on to set up your trace as an FFT (Fast Fourier Transform) function (next page).

PERFORM AN FFT OPERATION

Continuing from the preceding steps, set up Channel 1 for FFT. Fast Fourier Transform will convert your time domain waveform into a frequency domain spectrum similar to that of an RF spectrum analyzer display. But unlike the analyzer, which has controls for span and resolution bandwidth, with Waverunner you determine the FFT span using the scope's sampling rate (see Chapter 10, "Use Advanced Math Tools").

10. Press the button to select **FFT** from the Math Type menu.

Spectra will be shown with a linear frequency axis running from zero to the Nyquist frequency. The frequency scale factors (Hz/div) are in a 1-2-5 sequence. The processing equation is displayed at the bottom of the screen, together with the three key parameters that characterize an FFT spectrum:

Transform size N (number of input points)

Nyquist frequency (= 1/2 sample rate)

Frequency increment, Δf , between two successive points of the spectrum.

These parameters are related as: Nyquist frequency = $\Delta f * N/2$, where $\Delta f = 1/T$, and T is the duration of the input waveform record (10 * time/div). The number of output points is equal to N/2.

TIP: During FFT computation, the FFT sign is shown below the grid. The computation can take a while on long time-domain records, but you can stop it at any time by pressing any front panel button.

11. Press the button to select Power Spectrum from the menu



Power Spectrum is the signal power, or magnitude, represented on a logarithmic vertical scale: 0 dBm corresponds to the voltage (0.316 V peak), which is equivalent to 1 mW into 50 Ω . Power Spectrum is suitable for characterizing spectra that contain isolated peaks (dBm).

Other FFT functions available in this menu depend on the Waverunner math options installed in your scope (see page 55).

Phase is measured with respect to a cosine whose maximum occurs at the left-hand edge of the screen, at which point it has 0°. Similarly, a positive-going sine wave starting at the left-hand edge of the screen has a -90° phase. Phase is displayed in degrees.

Power Density: Signal power normalized to the bandwidth of the equivalent filter associated with the FFT calculation. Suitable for characterizing broadband noise. Power Density is displayed on a logarithmic vertical axis calibrated in dBm. It is available only with the WaveAnalyzer option for the Waverunner.

Magnitude: The peak signal amplitude is represented on a linear scale, in the same units as the input signal.

Real, Real + Imaginary, Imaginary: Complex result of the FFT processing in the same units as the input signal. These are only available with the WaveAnalyzer option.

12. Now turn the knob to select **Von Hann**  and press the button to select **AC**.

AC forces the DC component of the input signal to zero before FFT processing, and improves the amplitude resolution. This is especially useful when your input has a large DC component.

FFT windows define the bandwidth and shape of the FFT filter. (See Chapter 10, “Use Advanced Math Tools,” for the windows’ filter parameters.)

Von Hann (Hanning) windows reduce leakage and improve amplitude accuracy. But they also reduce frequency resolution.

Rectangular windows should be used when the signal is transient (completely contained in the time-domain window) or you know it to have a fundamental frequency component that is an integer multiple of the fundamental frequency of the window. Other signal types will show varying amounts of spectral leakage and scallop loss when you use a Rectangular window. To correct this, use another window type.

Hamming reduces leakage and improves amplitude accuracy, but also reduces frequency resolution.

Flat Top provides excellent amplitude accuracy with moderate leakage reduction, but also reduces frequency resolution.

Blackman-Harris windows reduce leakage to a minimum, but reduce frequency resolution.

13. In the final FFT step, press the button to select the source trace.

The “before” and “after” of your FFT computation is shown on the next page.

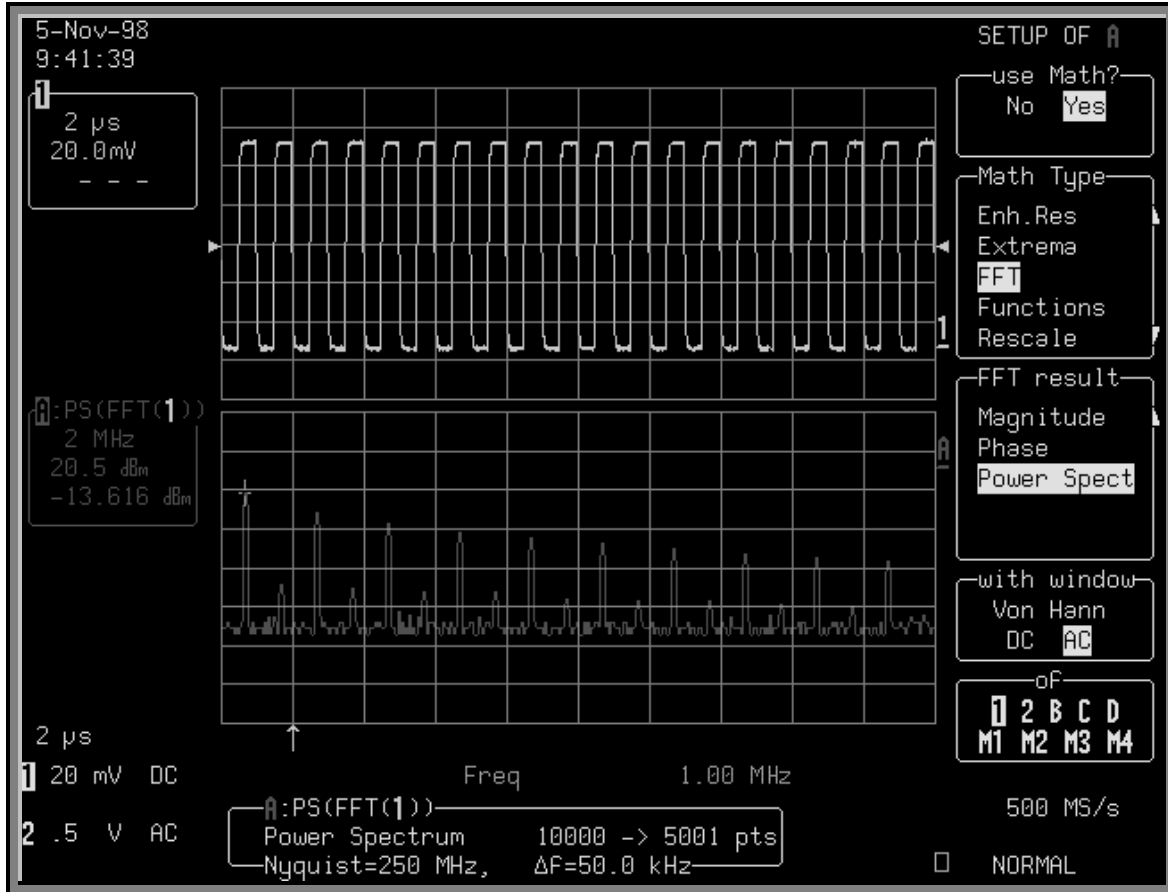

FFT Power Spectrum: The top grid shows the waveform in the time domain, while the bottom one shows it in the frequency domain, after FFT Power Spectrum has been applied. With the cursor measure tool (positioned here on the left-most peak of the FFT trace) you can read either the time or frequency of your waveform. Trace A's label indicates 2 MHz per division in the frequency domain. The memory status field beneath the grids gives other FFT information.

DO SUMMED AVERAGING

Now make a Summed Average of your waveform — again, going on from the previous steps. Averaging is normally used to eliminate noise.

14. Press the button to select **Average** from the Math Type menu.

15. Press the button to select 

Waverunner starts the calculation immediately.

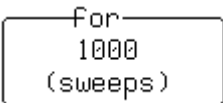
16. Turn the upper knob to set the number of sweeps  (up to 4000)

This is counted in the trace label, as shown here, at right:

If the optional Continuous Average is selected, the “for” menu becomes “with... weighting”. Use it to define the weight.

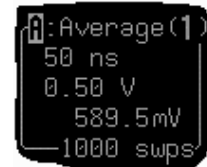

(See Chapter 10, “Use Advanced Math Tools,” for the difference between summed and continuous averaging.)

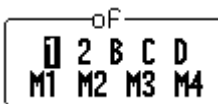
17. Finally, press the button to select the source trace: 

The type of result you can expect is illustrated on the next page.

PART ONE: GETTING STARTED

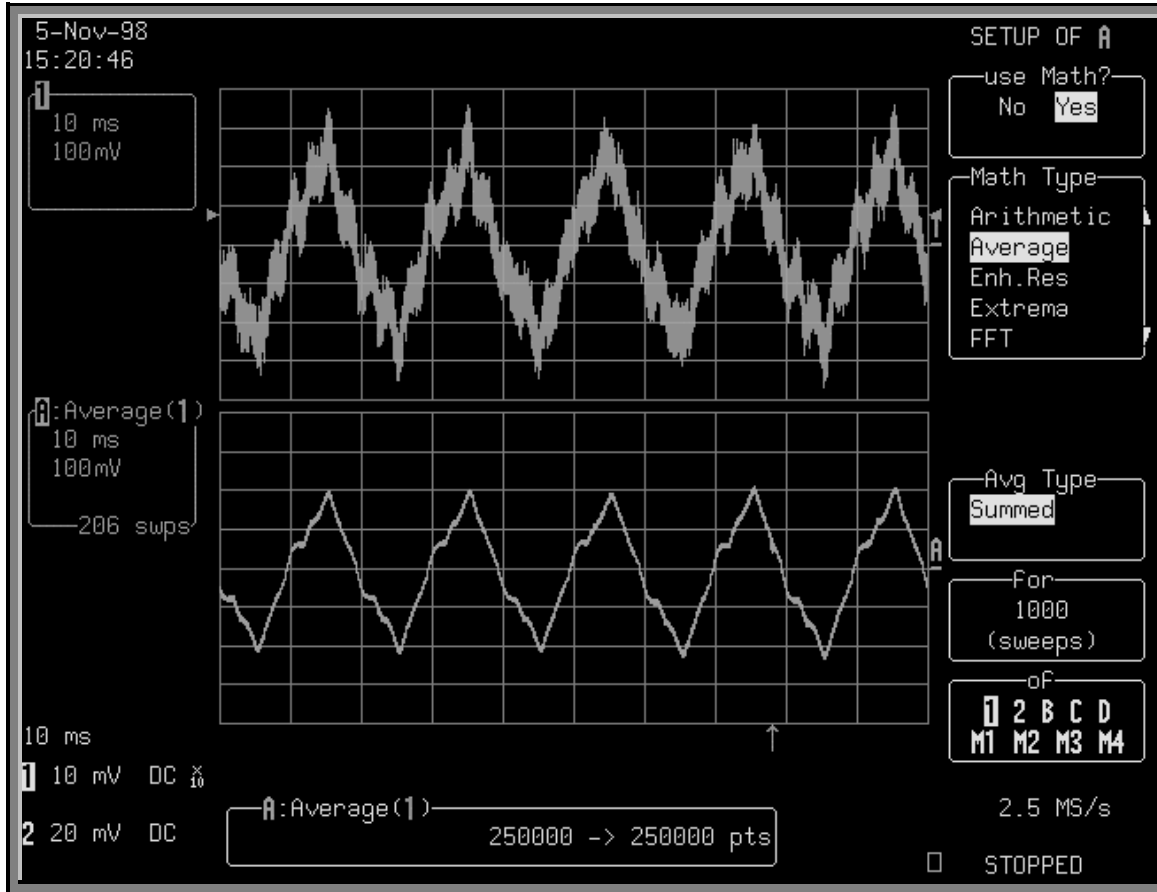

Summed Average: Noise evident in the signal shown in the top trace has been eliminated from the averaged waveform on the lower grid. The calculation was stopped after 206 sweeps. The number of points used in the calculation is shown in the information field at the bottom of the screen. The same number of points means that all points were used in the calculation.

Save and Recall Waveforms

Save your waveforms to internal reference memory — M1, M2, M3 or M4 — or to floppy disk or the optional PC Card slot (Memory card or HDD). Recall them later for further analysis. You could zoom them or perform more math.

NOTE: For each unit of record length per channel, or per zoom and math trace, a point can be stored in the waveform reference memories M1, M2, M3, or M4.

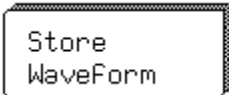
1. Press  and then the button for 

STORE W'FORMS

DO STORE
(1->M1)











store

1	2
A	B
C	D

All displayed

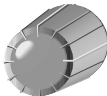
to

M1	M2	M3	M4
Flpy			

2. Use these menus to store your displayed waveform.
- 
 - 
 - 
 -  To store the waveform, which you first select from the menu below, to the memory or floppy disk (also selected below).
 - 
 - 
 -  To select the channel or trace whose waveform you wish to store.
 -  To select the internal reference memory, floppy, or optional storage device the waveform is to be saved to.
 -  See Chapter 12, "Use Waverunner with PC," for how to save waveforms in ASCII format.
 -  RETURN
3. Press to go back to the "W'FORM" menus in order to recall the waveform you have stored.

4. Press the button for

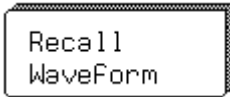

5. These menus will be displayed. Use them to recall your waveform.



To recall the waveform from memory or portable storage device.



To recall the selected waveform to the selected trace (see menus below).

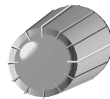

To select the memory in which the waveform you wish to display is stored.

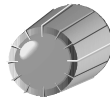

To select the trace on which the recalled waveform is to be displayed.

TIP: Transfer waveform data to PC and use the data for calculations with spreadsheet or math software. To do this, save your waveforms to floppy or an optional storage device in the ASCII format. Waverunner can save to floppy in ASCII traces of up to 50 000 points. You should remember that waveforms stored in ASCII cannot be called back into the oscilloscope. See Chapter 12, "Use Waverunner with PC."



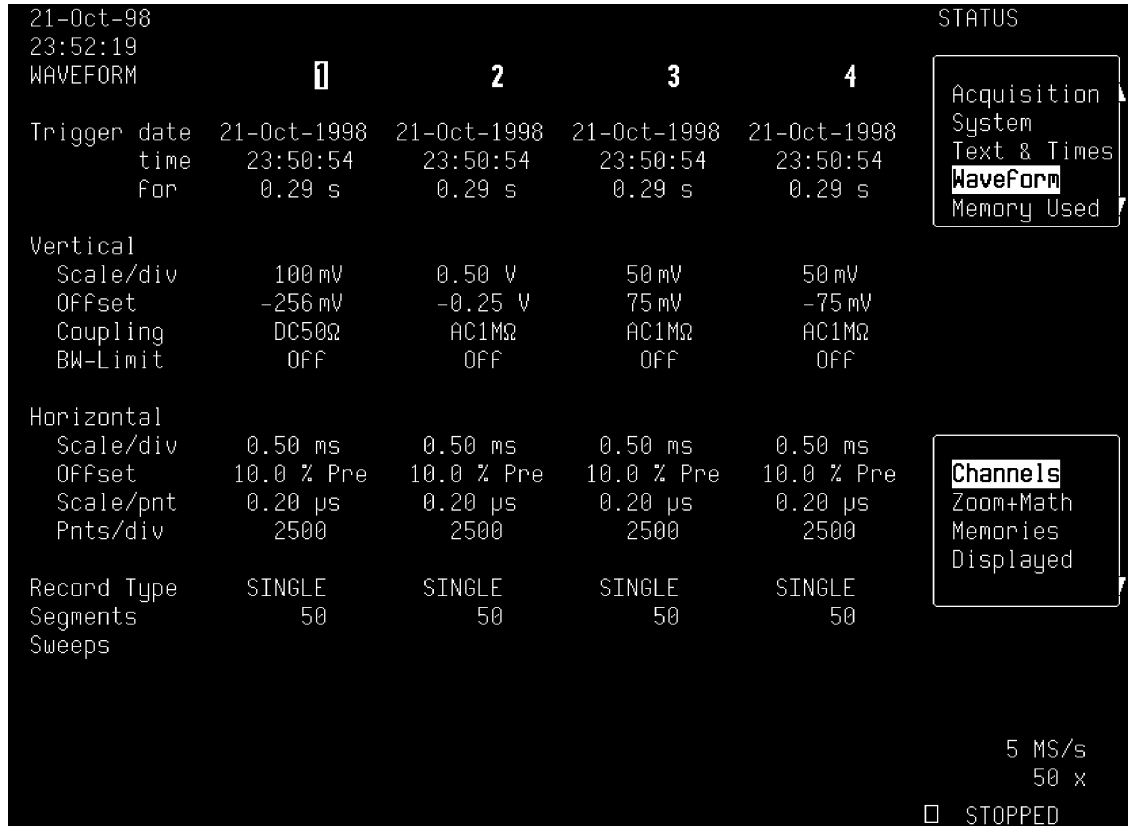

OBTAIN A WAVEFORM OR MEMORY STATUS REPORT

Display a summary of the status of your channels, zoom and math functions, waveform memories, and displayed traces. View the settings on your vertical and horizontal controls. Check on how much memory your Waverunner scope is using for storage of records. Clear and free up memory.



SCOPE STATUS

1. Press  to show the STATUS menus.
2. Press the button to select **Waveform** and the button for the waveform status summary of choice.
3. Press the button to select **Memory Used** to obtain a similar report on what you have stored and how much memory is available. Memories occupied by waveforms will be boxed, and empty ones indicated as such. You can also clear occupied memories by pressing the corresponding menu buttons. 

CHAPTER SIX: *Document Your Work*

In this chapter, see how

To print your display using the Waverunner internal printer

To print or plot your display with an external printer or plotter

To create TIFF and BMP image files

To store and retrieve floppy-disk, PC Memory-card and hard-disk-card files

To give custom names to your files and create directories

To add or delete file directories

To copy files from one portable storage device to another

Make a Hard Copy

Make a hard copy of your displayed traces and screen data using the scope's optional internal printer. Or print to an external printer or plotter using the rear GPIB, RS-232-C, or Centronics port. Create TIFF and BMP image files with the scope and save them to floppy disk, or optional PC memory or hard disk card.

UTILITIES

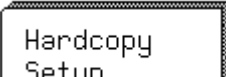
1. Press  to display the UTILITIES menus.
2. Then press the button for  to access these menus.

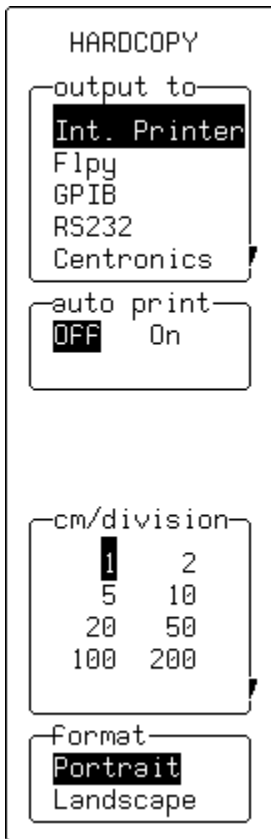

Use them to make a hard copy of your screen.

3. Press to select the optional internal printer, or another device to print or save to (see next page).

TIP: Connect an external printer or plotter using one of the ports on the rear of your Waverunner scope. Print or plot to an external device selected from the "output to" menu. A wide range of printers and plotters can be used.
4. Press to turn the auto-print function on or off: **On** will print a hard copy after every acquisition.
5. Press or turn to expand the waveform and show more detail.
6. Press or turn to select the page format.

PART ONE: GETTING STARTED

7. Press  to print a copy of the screen display.

PRINT SCREEN

TIP: Press  while printing to cancel.

PRINT, PLOT, OR COPY

1. Press the button to select a port, the PC Card slot, or floppy-disk drive:

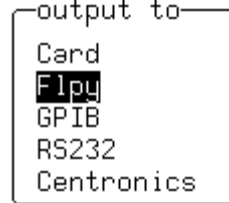

2. Press the button to select a printer, plotter, or graphic protocol (TIFF, BMP, or

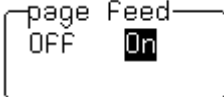

Other menus will appear according to your selection. The “plot size” and “pen number” menus appear when a plotter is selected. The “background” menu becomes available when a color or compressed TIFF or BMP graphic protocol is used. This gives you the choice between a black or white background for a screen image. Waverunner assigns file names automatically when copying to floppy or optional storage device (see page 69).

3. Press the button for  to start a new page each time you perform Step 4.

4. Press  to print, plot, or save a copy of the screen display to a printer, plotter, or graphic protocol.

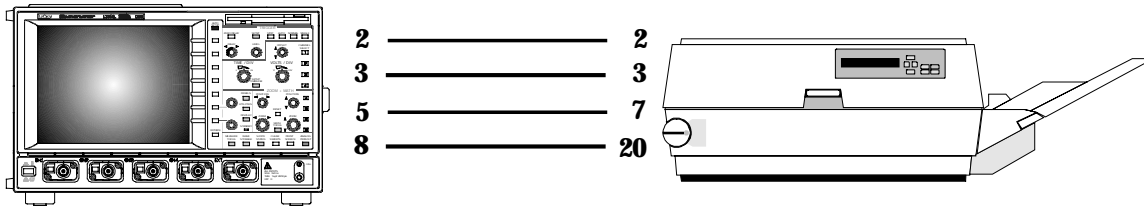

RS-232-C printer cabling: Connect your scope to a variety of external printers using the rear RS-232-C port. You could also connect to PC via GPIB, and use the computer to control a printer connected via RS-232-C. See Chapter 12, “Use Waverunner with PC,” for computer cabling.

Manage Floppy or Card Files

Use Waverunner mass-storage utilities to create waveform files on floppy-disk, or optional PC memory card or hard disk card. Give your files custom names, and create directories for them. Copy files from one portable storage device to another...

UTILITIES

1. Press  to display the UTILITIES menus.

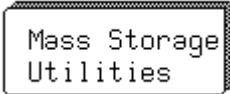
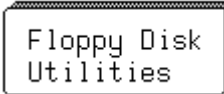
2. Press the button for  and then the button for 

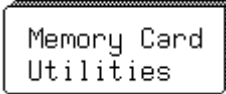
Or, if saving to an optional device, such as memory card, in the PC Card slot: 

3. Follow the on-screen instructions; when saving to floppy disk, press the button to 

4. From the menus shown for floppy disk or PC Card slot, press the button for 

5. Use the menus displayed to format the storage medium in DOS and, in the case of the floppy disk, to select density. Or copy a machine template (an ASCII file containing binary description information) to the storage device.

RETURN

6. Press  twice to go back to the MASS STORAGE menus.

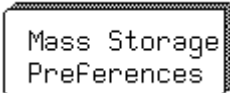
7. Press the button for  to display the PREFERENCES menus.

These menus allow you to select the working directory, to delete directories, and access the File Name Preferences and Add New Directory menus, described on the following pages.

PART ONE: GETTING STARTED

- Press the button to select a directory for file storage and retrieval from the work with menu. Or, the selected directory can be deleted using the DELETE THIS DIRECTORY menu.

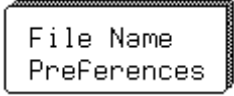
- Next, press the button for  to access these menus.

CUSTOMIZE FILE NAMES

Waverunner gives default names to your files. But you can also customize them using these menus.

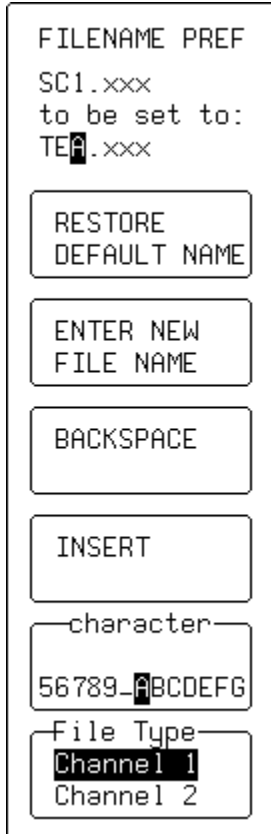

- Give a custom name to your waveform, setup, or hardcopy file.



To select the character to be modified using the character menu (below).



To restore the file type selected in the File Type menu (see below) to its default name.



To validate a newly defined name.



To move back a space and erase the previous character in the file name.



To move forward and create a space for the insertion of a character.

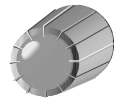

To select characters — numbers or letters — for creating the file name, using the knob.

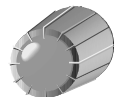

To select the channel of the file type to be customized.

RETURN



- Press to go back to PREFERENCES menus.

ADD A NEW DIRECTORY

12. Press the button for

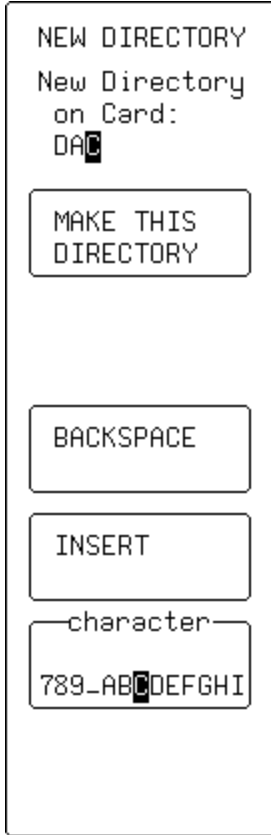

13. Then use these menus to create a new directory for your custom-named files.



To select the character to be modified using the character menu (below).



To validate the new directory.



To move back a space and erase the previous character in the file name.



To move forward and create a space for the insertion of a character.

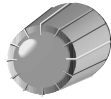

To select characters — numbers or letters — for creating the file name, using the knob.

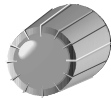

RETURN



14. Press twice to go back to the MASS STORAGE menus.

PART ONE: GETTING STARTED

COPY FILES

You can copy files from one portable storage device to another: from a floppy disk in the Waverunner floppy disk drive, to a memory card or hard disk card in the scope's PC Card slot (or vice versa).

15. Press the button for 

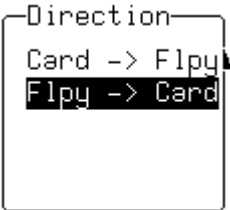
16. Press the button to select the devices you wish to transfer from and to: 

17. Press the button to transfer certain types of file or all files on the storage device: 

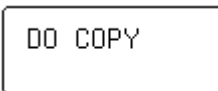
18. Press the button to 

HOW WAVERUNNER MANAGES MASS STORAGE



When you select *Mass Storage Utilities* from *UTILITIES*, the *MASS STORAGE* menu group gives you access to the mass-storage file system controls. The system supports storage and retrieval of data files to and from floppy disk in either the DOS 1.44 MB or 720 kB format.

Waverunner writes and reads all files to and from the floppy disk using the current working directory. If the new file being stored bears the same name as an existing file on the same storage medium, the old file will be deleted. The default name of the working directory is *LECROY_1.DIR*. This directory is automatically created when the media is formatted. If the media is formatted elsewhere — for instance on a PC — the directory will be created the first time a file is saved to the floppy disk. The maximum number of files allowed in any one directory is 2400.

You can change the name of the working directory to any valid DOS directory name, using the file-name preferences menu. All working directories are created as sub-directories from the root directory. As in MS-DOS, the file name can contain up to eight characters followed by an extension of three characters.

A file is treated as: a panel setup if its extension is *PNL*; a waveform if its extension is a three-digit number; a waveform template if its extension is *TPL*; a hard copy if its extension is *TIF*, *BMP*, or *PRT*; and *HPGL* if its extension is *PLT*. The table below shows how files are named.

FILE OR DIRECTORY TYPE	DEFAULT NAME	CUSTOMIZED NAME
<i>Manually stored waveforms</i>	Stt.nnn	xxxxxxxx.nnn
<i>A utomatically stored waveforms</i>	Att.nnn	xxxxxxxx.nnn
<i>Panel files</i>	Pnnn.PNL	xxxxnnn.PNL
<i>Hardcopy files</i>	Dnnn.TIF Dnnn.BMP Dnnn.PRT Dnnn.PLT	xxxxnnn.TIF xxxxnnn.BMP xxxxnnn.PRT xxxxnnn.PLT
<i>Template files</i>	LECROYvv.TPL	Cannot be changed
<i>Directory name</i>	LECROY_1.DIR	xxxxxxxx
<i>Spreadsheet</i>	Sttnn.TXT	xxxxnnn.TXT
<i>MA TL A B</i>	Sttnn.DAT	xxxxnnn.DAT
<i>MathCad</i>	Sttnn.PRN	xxxxnnn.PRN

KEY TO MASS-STORAGE TERMS			
x	<i>A ny legal DOS file-name character</i>	w	<i>The template version number: for example, for a version 2.2, the template will be saved as L E CROY22.TPL</i>
tt	<i>The trace name of C1, C2, C3, C4, TA, TB, TC, TD</i>	TIF BMP	<i>Tagged Image Format, bitmap image files</i>
nnn	<i>A three-digit decimal sequence number starting at 001 that is automatically assigned</i>	PRT	<i>Hard copy printer files</i>
PLT	<i>HPGL plotter or vector files</i>		

The default notation for waveform files is *Stt.nnn* for manually stored files, and *A tt.nnn* for automatically stored files. The characters *S* and *A* represent the two storage methods. When automatically generating a file name, Waverunner's system uses the assigned name plus a three-digit sequence number. If the assigned waveform name is already in the default 'Stt' form (such as *SC1*, *STB*) the name will be changed to the 'A tt' form: *AC1*, *ATB* and so on. All other user-assigned names remain as entered.

If you select **Fill** and use default names, the first waveform stored will be *A xx.001*, the second *A xx.002*, and so on. Waverunner continues storing until the storage medium is filled, the file number reaches 999, or there are more than 2400 files in the current working directory.

If you select **Wrap**, the oldest auto-stored waveform files will be deleted whenever the medium becomes full. The remaining auto-stored waveform files will be renamed — the oldest group of files will be named "A xx.001", the second oldest "A xx.002", and so on.

The current sequence number is deduced from Waverunner's inspection of all file names in the working directory, regardless of file type — panel, hard copy, or waveform. The oscilloscope determines the highest occupied numeric file-name extension of the form 'nnn', and uses the next highest number as the current generation number for storage operations. When you delete a file generation, Waverunner deletes all files designated with the three-digit sequence number of the file-name extension, regardless of file type.

The mass-storage file system indicates media size and storage availability in kbytes where 1 kbyte = 1024 bytes. Many media manufacturers specify the available storage in Mbytes where 1 Mbyte = 1 million bytes. This results in an apparent mismatch in specified versus actual media storage availability, when in fact the availability in bytes is identical.

If the floppy's write-protection switch has been pushed to the active position, Waverunner displays the message "Device is Write Protected" on the upper part of the grid whenever the medium is accessed for writing.

See Chapter 12, "Use Waverunner with PC," for how to transfer files to PC.





PART TWO

LOOKING DEEPER

Part Two of the manual covers the Waverunner features you'll use for more advanced waveform operations: RIS and sequence sampling, SMART Trigger, Advanced waveform processing. It also looks deeper into operations already covered in Part One.

Use Part Two as an advanced guide and a reference for understanding important functions of your digital oscilloscope.

CHAPTER SEVEN : *A Question of Timebase*

In Part One you saw how to adjust and set up timebase. Next, take a closer look at the Waverunner timebase sampling modes.

In this chapter, see how

To choose a sampling mode

To use single-shot or RIS modes

To use sequence mode

To sample externally

Choose a Sampling Mode

Depending on your timebase, you can choose any of three sampling modes: single-shot, RIS (Random Interleaved Sampling), or roll mode. In addition, on timebases suited to single-shot and roll, the acquisition memory can be subdivided into user-defined segments to give sequence mode.

SINGLE-SHOT — WAVERUNNER'S BASIC CAPTURE TECHNIQUE

A single-shot acquisition is a series of digitized voltage values sampled on the input signal at a uniform rate. It is also a series of measured data values associated with a single trigger event. The acquisition is typically stopped a defined number of samples after this event occurs: a number determined by the selected trigger delay and measured by the timebase. The waveform's horizontal position — and waveform display in general — is determined using the trigger event as the definition of time zero.

You can choose either a pre- or post-trigger delay. Pre-trigger delay is the time from the left-hand edge of the Waverunner grid *forward* to the trigger event, while post-trigger delay is the time *back* to the event. You can sample the waveform in a range starting well before the trigger event up to the moment the event occurs. This is 100% pre-trigger, and it allows you to see the waveform leading up to the point at which the trigger condition was met and the trigger occurred. (Waverunner offers up to one million points of pre-trigger information.) Post-trigger delay, on the other hand, allows you to sample the waveform starting at the equivalent of 10 000 divisions after the event occurred.

Because each Waverunner input channel has a dedicated ADC (Analog-to-Digital Converter), the voltage on each is sampled and measured at the same instant. This allows very reliable time measurements between the channels.

On fast timebase settings, the maximum single-shot sampling rate is used. But for slower timebases, the sampling rate is decreased and the number of data samples maintained.

The relationship between Waverunner sample rate, memory and time can be simply defined as:

$$\text{Capture time} = \frac{1}{\text{Sample Rate}} \times \text{Memory},$$

and

$$\frac{\text{Capture time}}{10} = \text{Time/Division}.$$

RIS — FOR HIGHER SAMPLE RATES

RIS (Random Interleaved Sampling) is an acquisition technique that allows effective sampling rates higher than the maximum single-shot sampling rate. It is used on repetitive waveforms with a stable trigger. The maximum effective Waverunner sampling rate of 25 GS/s can be achieved with RIS by making 50 single-shot acquisitions at 500 MS/s or 200 MS/s, depending on model. The bins thus acquired are positioned approximately 40 ps apart. The process of acquiring these bins and satisfying the time constraint is a random one. The relative time between ADC sampling instants and the event trigger provides the necessary variation, measured by the timebase to 5 ps resolution.

It takes Waverunner 30 trigger events to complete a 1 GS/s RIS acquisition, and 230 events for a 25 GS/s acquisition. But sometimes the scope needs many more than this. It then interleaves these segments (Fig. 1) to provide a waveform covering a time interval that is a multiple of the maximum single-shot sampling rate. However, the real-time interval over which Waverunner collects the waveform data is much longer, and depends on the trigger rate and the amount of interleaving required. The oscilloscope is capable of acquiring approximately 40 000 RIS segments per second.

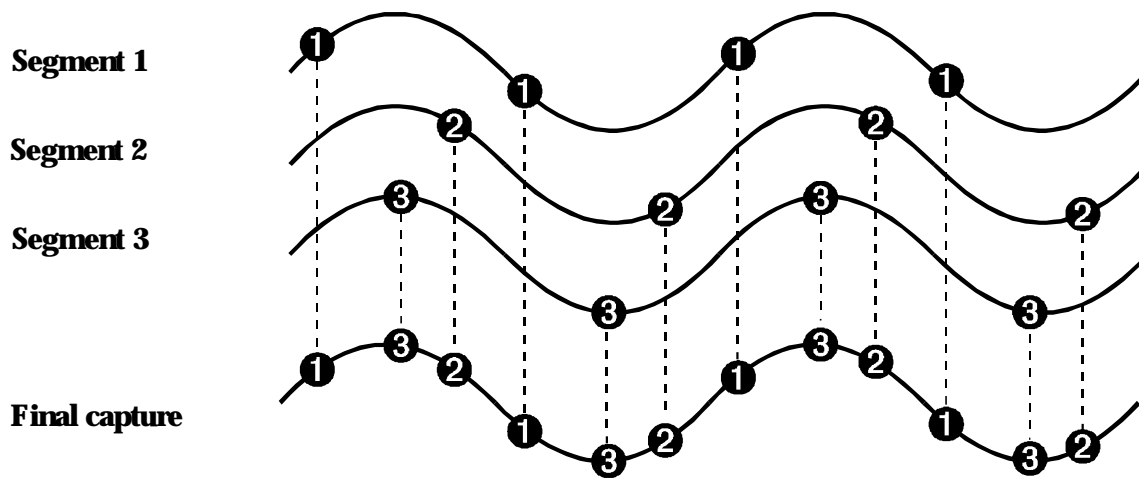

Figure 1. Buildup of an RIS waveform.

ROLL — DISPLAY IN REAL-TIME

Waverunner roll mode displays in real time incoming points in single-shot acquisitions that have a sufficiently low data rate. At timebase settings of ≥ 0.5 s/div the oscilloscope rolls the incoming data continuously across the screen until a trigger event is detected and the acquisition is complete. Even when real-time display is not possible, the data will continue to be acquired. This works in the same way as a strip-chart recorder: the latest data is used to update the trace display. Waveform math and parameter calculations are performed on the completed waveforms, after the real-time display has stopped.

SEQUENCE — WORKING WITH SEGMENTS

In sequence mode, the complete waveform consists of a number of fixed-size segments (Fig 2) acquired in single-shot mode (see Waverunner specifications for the limits). You select the number of segments to be captured, and can then select each segment, individually, and use it for processing with Math and Measure tools.

Sequence offers a number of unique capabilities. With it, you can limit dead time between trigger events for consecutive segments. Waverunner can capture in fine detail complicated sequences of events over large time intervals, while ignoring the uninteresting periods between the events. You can also make time measurements between events on selected segments using the full precision of the acquisition timebase.

Trigger time stamps of 1 ns resolution are given for each of the segments in the Text & Times Status menu. Each individual segment can be zoomed or used as input to math functions.

Waverunner uses the sequence timebase setting to determine the capture duration of each segment: 10 x time/div. The oscilloscope uses this setting — with the desired number of segments, maximum segment length and total available memory — to determine the actual number of samples or segments, and time or points. However, the display of the complete waveform with all its segments may not entirely fill the screen.

Sequence mode can also be used in remote operation to take full advantage of Waverunner's high data transfer capability (see Chapter 12, "Use Waverunner with PC," and the *Remote Control Manual*).

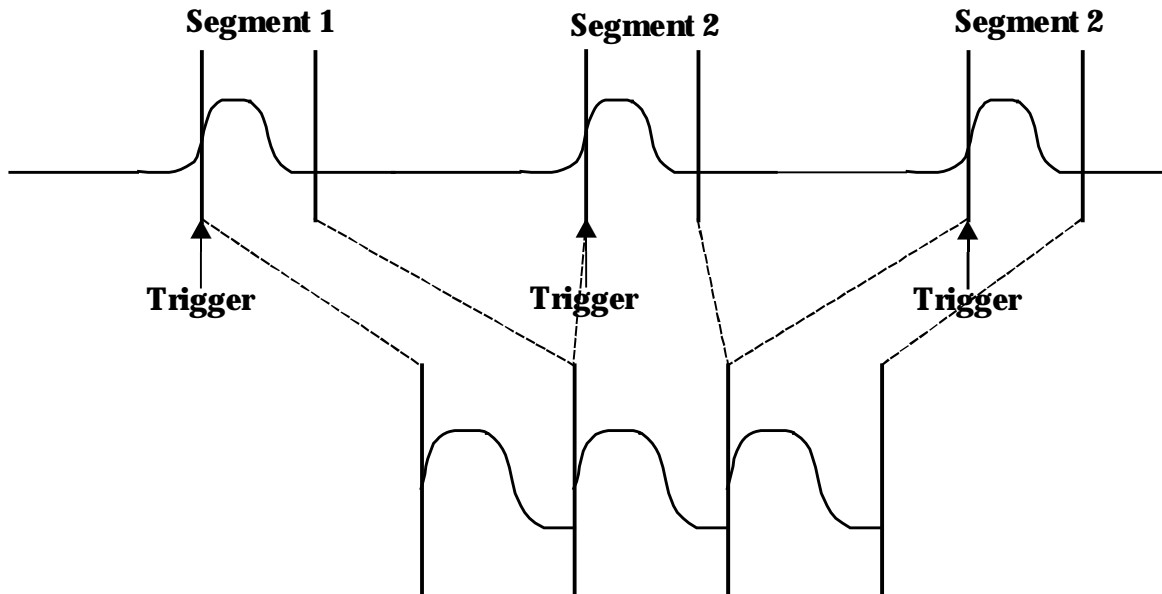

Figure 2. How Waverunner captures segments. See page 83 for how to obtain a sequence status summary.

PART TWO: LOOKING DEEPER

PAIRING CHANNELS (LT364 SERIES ONLY)

A pair of channels can be combined on channel 2 or 3, with channels 1 and 4 disabled or available only for triggering. On these paired channels the maximum sampling rate is doubled and the record length is increased by two times.

Channels are combined to increase sample rate or memory size or both in order to capture and view a signal in all its detail. When combined, the channels (like the EXT BNC input) that are not involved in the combination remain available for triggering, even though they are not displayed. It is preferable to select "Automatic" to combine channels and have the remaining acquisition channels available for triggering. The channels available for triggering only would be indicated by "trig only" in the Acquisition Summary Field.

Refer to the "Acquisition Modes" table in Appendix A for maximum sample rates.

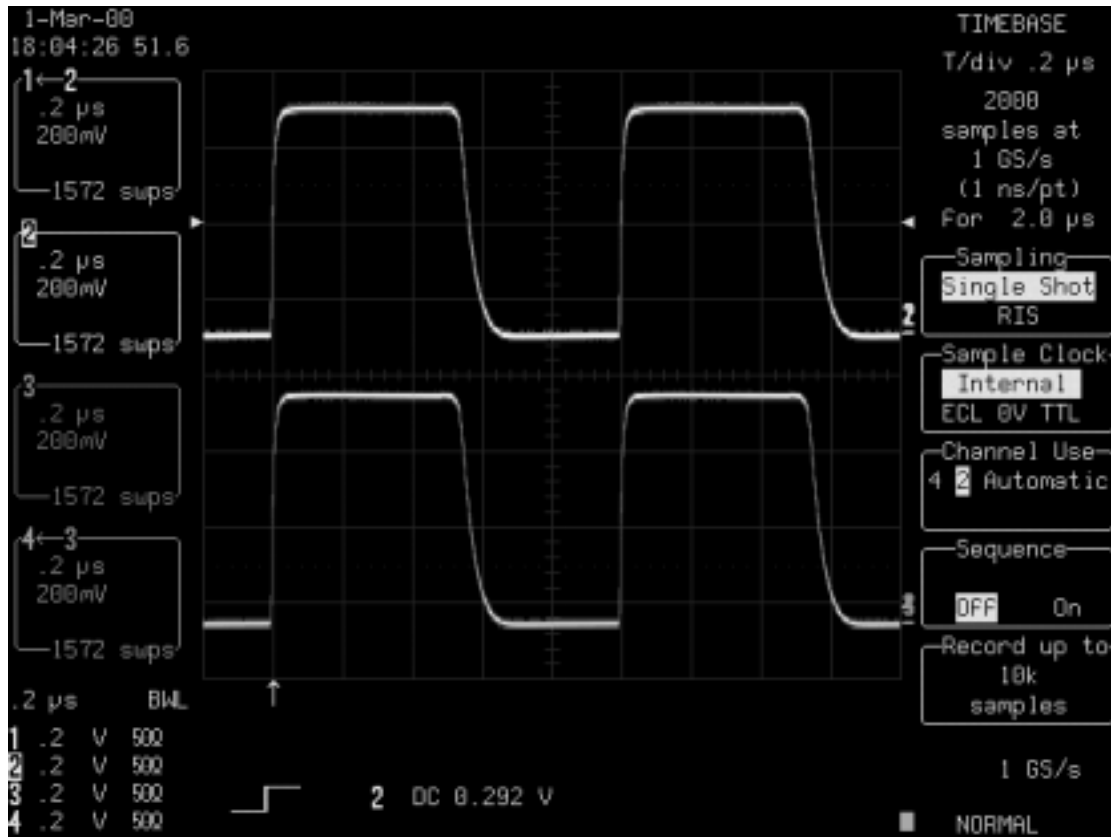

Combining of Channels

Use a Sampling Mode

SET UP FOR SINGLE-SHOT OR RIS

1. Press  and access the TIMEBASE SETUP menus.

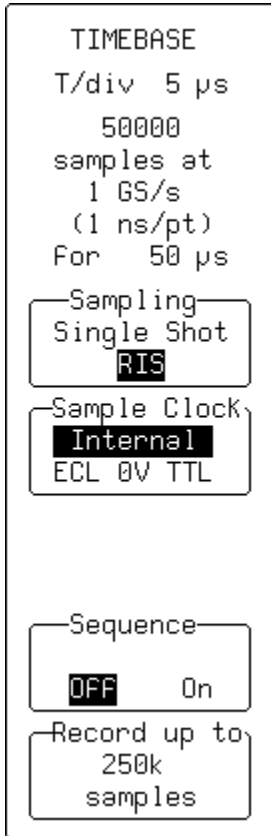

2. Use these menus to set up the Waverunner timebase for Single-Shot or RIS.



To select **Single-Shot** for display of data collected during successive single-shot acquisitions from the input channels, or **RIS** for a higher sampling rate with a repetitive input signal and stable trigger.

To select from an internal or external clock source. See page 83 for external clock.

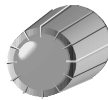

To switch Sequence mode **On** or **Off**. Use the knob to choose the number of segments. See next page.

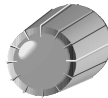

To select the maximum number of samples to be acquired, using the menu knob.

SET UP FOR SEQUENCE CAPTURE

TIMEBASE
T/div 2 μ s
50 * 5000
samples at
250 MS/s
(4 ns/pt)
For 20 μ s

Sampling
Single Shot

Sample Clock
Internal
ECL OV TTL

Sequence
50 segments
OFF **On**



Max. segment
500K
samples

3. Activate sequence mode using the Sequence menu and then use these menus to do sequence sampling

SCOPE
STATUS

TIP: Press  and select "Text and Times" to obtain a status report on a trace or memory's sequence segment range.

 To select **Single-Shot** for sequence sampling.

 To select **Internal** or external — **ECL, OV, TTL** — clock modes. Select internal unless using an external clock signal (see next page).
 You can select a time-out for sequence mode using the UTILITIES, Special Modes, and Timebase Trigger menu.

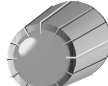
  To turn Sequence **On** or **Off**.

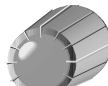
  To select with the knob the maximum record length, in samples, for each sequence segment.

NOTE: In sequence mode: Press the **SINGLE** button and Waverunner will fill the chosen number of segments and then stop capturing. But if there are not enough trigger events to fill the segments, Waverunner will not stop capturing until you press **STOP**. If you press **NORMAL** the segments will be filled and the data processed and displayed. Then, if more trigger events occur, Waverunner will restart capturing from the first segment. When you press **AUTO**, capturing will also be restarted from the first segment, if the time between two consecutive triggers exceeds a selected time-out.

However, avoid any unnecessary button pushing and knob turning in Sequence mode.

OBTAIN A SEQUENCE STATUS SUMMARY

Display a summary of the status of your sequence acquisition.

4. Press  to show the STATUS menus.
5. Press the button to select **Text & Times**.

PRINT
SCREEN

TIP: Press  to document your status summary and make a hard copy. Printing (and storage) operations will include undisplayed text.

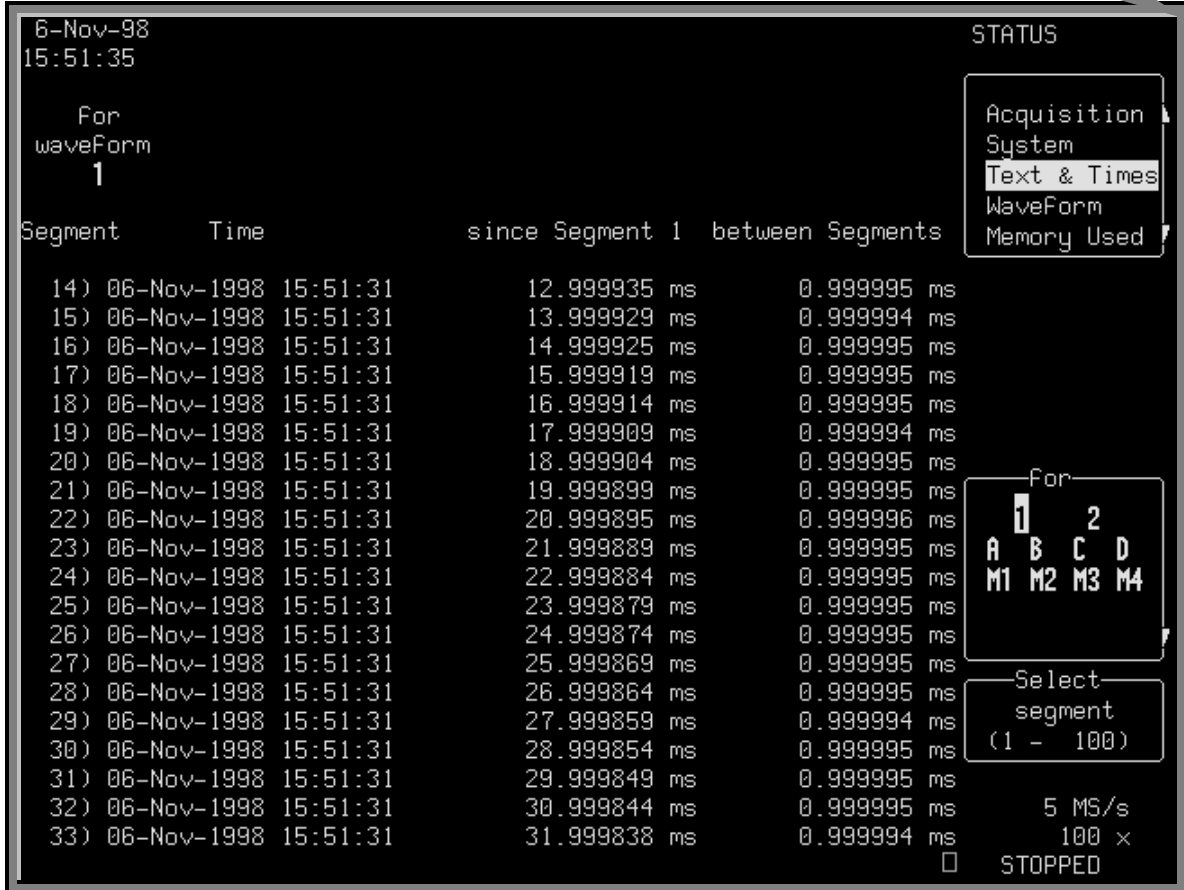

6-Nov-98
15:51:35

For
waveForm
1

STATUS

Acquisition System
Text & Times
 WaveForm
 Memory Used

Segment	Time	since Segment 1	between Segments
14)	06-Nov-1998 15:51:31	12.999935 ms	0.999995 ms
15)	06-Nov-1998 15:51:31	13.999929 ms	0.999994 ms
16)	06-Nov-1998 15:51:31	14.999925 ms	0.999995 ms
17)	06-Nov-1998 15:51:31	15.999919 ms	0.999995 ms
18)	06-Nov-1998 15:51:31	16.999914 ms	0.999995 ms
19)	06-Nov-1998 15:51:31	17.999909 ms	0.999994 ms
20)	06-Nov-1998 15:51:31	18.999904 ms	0.999995 ms
21)	06-Nov-1998 15:51:31	19.999899 ms	0.999995 ms
22)	06-Nov-1998 15:51:31	20.999895 ms	0.999996 ms
23)	06-Nov-1998 15:51:31	21.999889 ms	0.999995 ms
24)	06-Nov-1998 15:51:31	22.999884 ms	0.999995 ms
25)	06-Nov-1998 15:51:31	23.999879 ms	0.999995 ms
26)	06-Nov-1998 15:51:31	24.999874 ms	0.999995 ms
27)	06-Nov-1998 15:51:31	25.999869 ms	0.999995 ms
28)	06-Nov-1998 15:51:31	26.999864 ms	0.999995 ms
29)	06-Nov-1998 15:51:31	27.999859 ms	0.999994 ms
30)	06-Nov-1998 15:51:31	28.999854 ms	0.999995 ms
31)	06-Nov-1998 15:51:31	29.999849 ms	0.999995 ms
32)	06-Nov-1998 15:51:31	30.999844 ms	0.999995 ms
33)	06-Nov-1998 15:51:31	31.999838 ms	0.999994 ms

For
 1 2
 A B C D
 M1 M2 M3 M4

Select
 segment
 (1 - 100)

5 MS/s
100 ×
STOPPED

Press the *SCOPE STATUS* button for a full status summary of your sequence acquisition. Use the *Select segment* menu and its button and knob to scroll down the segment list.

OR SAMPLE EXTERNALLY

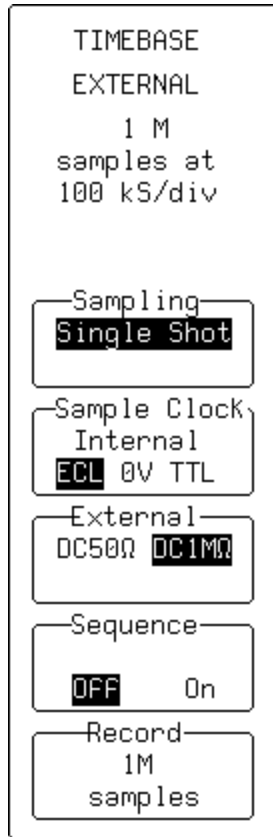

Use an external clock at a fixed frequency (see Appendix) to control and synchronize the sampling with an external signal source connected to the Waverunner rear EXT signal input.



This menu is inactive when the external sample clock is being used. **Single-Shot** is selected by default.



To specify the effective threshold for sampling the EXT input: 1.3 V with **ECL**, 0.0 V with **0V**, or +1.5 V with **TTL** selected.

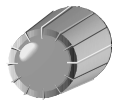

To turn Sequence **On** or **Off**. Use the knob to set the number of segments.

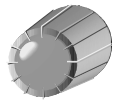

To select with the knob the maximum record length, in samples, for each segment.

NOTE: External clock modes are available only if the EXT trigger is NOT the trigger source. Trigger time stamps and the AUTO sequence time-out feature are unavailable when you use an external clock signal. And inter-segment dead time is NOT guaranteed.

External clock time/div is expressed in samples per division, as is the trigger delay, which can be adjusted normally. No attempt is made to measure the time difference between the trigger and the external clock, so successive acquisitions of the same signal can appear to jitter on the screen. Waverunner requires a number of pulses to recognize the external clock signal. It stops capturing only when the trigger conditions have been satisfied and the appropriate number of data points have been accumulated. Any adjustment to the TIME/DIV knob automatically returns the scope to normal (internal) clock operation.



BLANK PAGE

CHAPTER EIGHT: *Trigger Smart*

More about Edge triggering. And introducing the SMART Trigger range for capturing complex waveform characteristics.

In this chapter, see how

To hold off with Edge Trigger

To capture rare phenomena with Glitch trigger

To set up an exclusion trigger

To determine trigger level, coupling and slope

To trigger on intervals

To use State and Edge Qualified triggers

To trigger on lost signals using Dropout trigger

To trigger on TV signals

Pattern Trigger

Hold Off by Time or Events

Holdoff is an additional condition of Edge trigger (see Chapter 2, “Simply Trigger”). It can be expressed either as a period of time or an event count. Holdoff disables the trigger circuit for a given period of time or events after the last trigger occurred. Events are the number of occasions on which the trigger condition is met. The trigger will again occur when the holdoff has elapsed and the trigger’s other conditions are met. Use holdoff to obtain a stable trigger for repetitive, composite waveforms. For example, if the number or duration of sub-signals is known you can disable them by choosing an appropriate holdoff value. Qualified triggers operate using conditions similar to holdoff (see page 100).

HOLD OFF BY TIME

Sometimes you can achieve a stable display of complex, repetitive waveforms by placing a condition on the time between each successive trigger event. This time would otherwise be limited only by the input signal, the coupling, and Waverunner’s bandwidth. Select a positive or negative slope, and a minimum time between triggers. The trigger is generated when the condition is met after the selected holdoff time, counted from the last trigger (Fig 1). Any time between 10 ns and 20 s can be selected. The delay is initialized and started on each trigger.

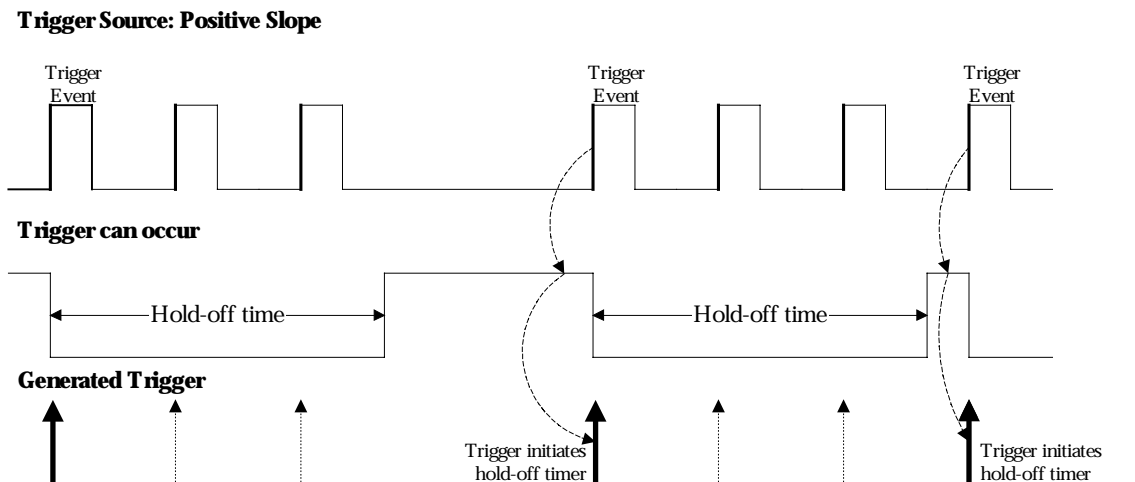

Figure 1. Edge Trigger with Holdoff by Time. The bold edges on the trigger source indicate that a positive slope has been selected. The broken upward-pointing arrows indicate potential triggers, which would occur if other conditions are met. The bold arrows indicate where the triggers actually occur when the holdoff time has been exceeded.

HOLD OFF BY EVENTS

Select a positive or negative slope and a number of events. An event is the number of times the trigger condition is met after the last trigger. A trigger is generated when the condition is met after this number, counted from the last trigger. The count is initialized and started on each trigger. For example, if the selected event number is two (Fig. 2), the trigger will occur on the third event. From one to 99 999 999 events can be selected.

Trigger Source: Positive Slope

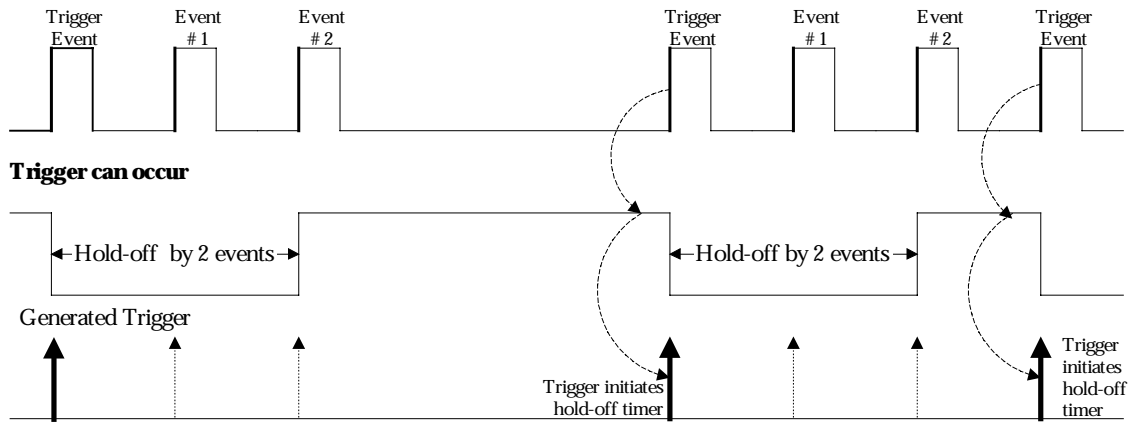



Figure 2. Edge Trigger with Holdoff by Events (in this example, two events). The bold edges on the trigger source indicate that a positive slope has been selected. The broken, upward-pointing arrows indicate potential triggers, while the bold ones show where triggers actually occur after the holdoff expires.

Trigger SMART



You have seen how to trigger on signals using Edge trigger, and the conditions of level, coupling and slope, and holdoff. Waverunner also offers a range of sophisticated triggers that enable you to trigger on these conditions, as well as many other complex waveform characteristics. Use the SMART Trigger range to set additional qualifications before a trigger is generated. Catch rare phenomena such as glitches or spikes, specific logic states, or missing bits. Capture intervals, abnormal signals, or TV signals. Trigger on state or edge qualified events and dropouts.

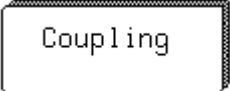

CATCH A GLITCH

Finding and capturing elusive glitches — abnormally wide pulses in a signal — is simple with the Glitch trigger.

1. Connect your signal to the Waverunner.
2. Simultaneously press the second and fifth menu buttons from the top, and  to return the scope to its default power-up settings. And turn off any unwanted displayed trace.

3. Press the button for  and set Coupling to match the source signal's impedance.

4. Press  and then  to display a normal waveform. Viewing this signal during several captures would reveal the occasional glitch. The goal of the measurement is to catch this event by setting a trigger adapted to it.

5. Press TRIGGER  and then the button to select .

6. Press the button for  and display these menus:

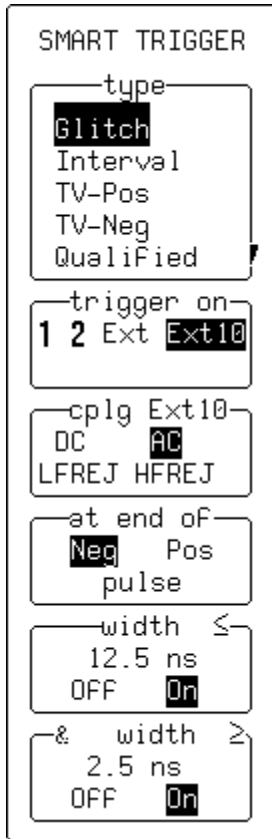

Use these menus to set up to trigger on a glitch, or to create an exclusion trigger (see page 93).

7. Select **Glitch** to catch pulses of a chosen width. Capture narrow pulses less than or equal to, or greater than or equal to, a given time limit: the pulse's width. You can also set up to exclude or include certain events (see page 93).
8. Select the trigger source. This could be a signal on a channel, the line voltage that powers the Waverunner or the EXT connector.
9. Select the coupling for the trigger source.
10. Place the trigger point at the end of a positive or negative slope. See NOTE this page.
11. Press the button to set to **On** and to trigger if the pulse is less than or equal to the value set with the knob (range: 2.5 ns to 20 s). Use in combination with "width ≤" below.
12. Press the button to set to **On** and to trigger if the pulse is greater than or equal to the value set with the knob (range: 2.5 ns to 20 s). Use in combination with "width ≥," combined to target glitches within ("&") a certain range if the "width ≤" value is greater than the "width ≥" value. "OR" in the menu indicates that glitches above or below this range will be targeted.

NOTE: Waverunner must first "see" the pulse before it can tell its width and know exactly when to trigger. If the glitch on which you want to trigger is on a negative pulse, choose "Pos" from the at end of menu. But if the glitch is on a positive pulse, choose "Neg."

TIP: Use Persistence to reveal the glitch shape, then match the trigger level to the level at which the glitch appears.

- NORMAL
13. Press  to arm the scope. Then wait for the trigger condition to become valid. See next page.

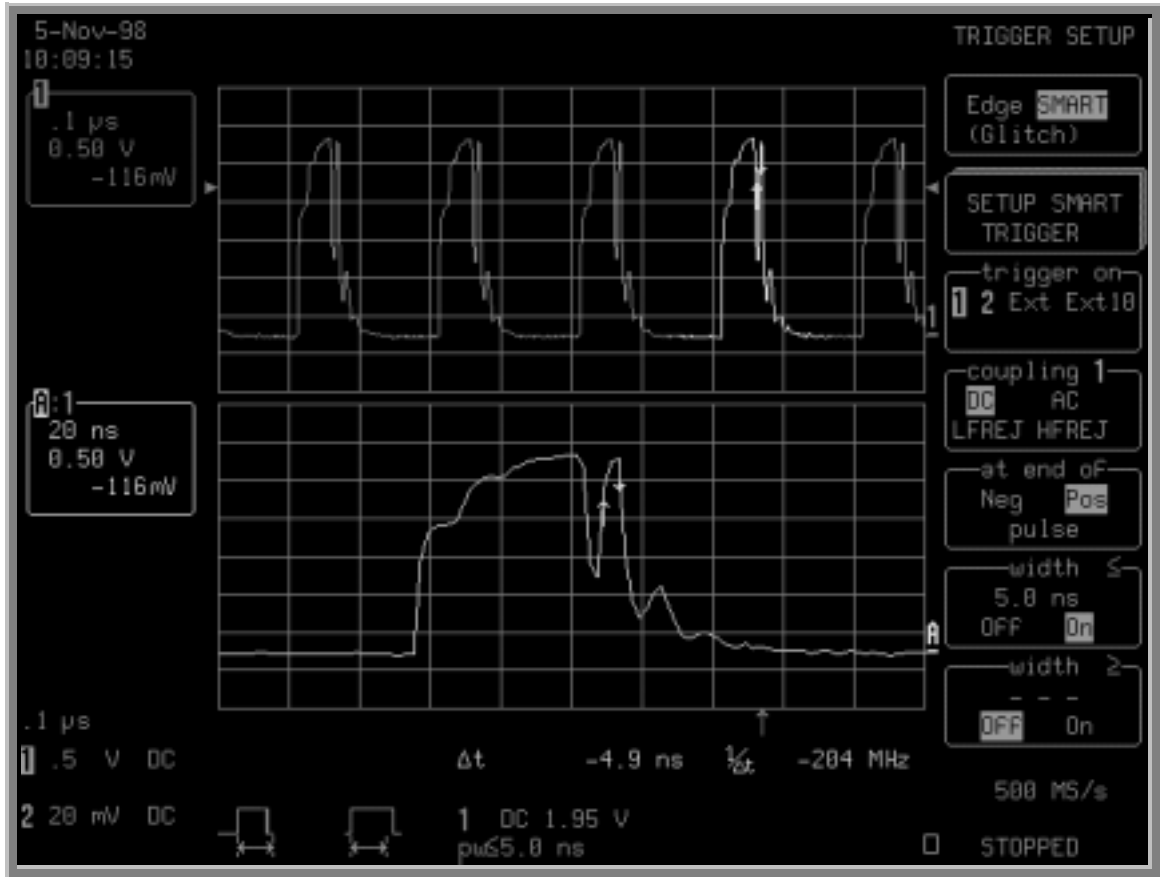

Trigger on a glitch of width ≤ 5.0 ns on the negative slope. Here, the glitch is marked by arrow cursors on the waveform. Trace A on the lower grid is a zoom of the waveform on the top grid. Information on the trigger is given beneath the grid.

NOTE: *If, for example, the glitch's width is lower than the signal's, set the trigger to a smaller width than that of the signal. The signal's width as determined by the Waverunner trigger comparator depends on the DC trigger level. And if that level were to be set at the middle of a sine wave, for example, the width could then be considered as the half period. But if the level were higher, the signal's width would be considered to be less than the half period.*

HOW GLITCH TRIGGER WORKS

Pulse smaller than selected pulse width: Select a maximum pulse width (Fig. 3). This glitch trigger is generated on the selected edge when the pulse width is less than or equal to the selected width.



The timing for the width is initialized and restarted on the opposite slope to that selected. Widths of between 2.5 ns and 20 s can be selected, but typically triggering will occur on glitches 2 ns wide.

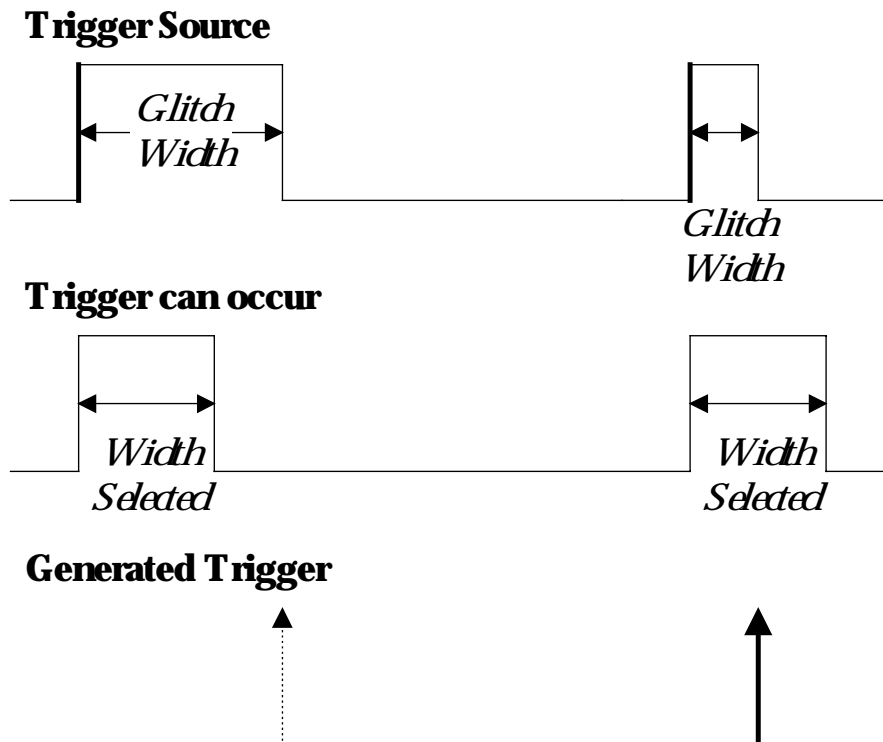
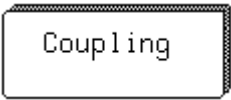



Figure 3. Glitch Trigger: in this example triggering on a pulse width less than or equal to the width selected. The broken upward arrow indicates a potential trigger, while the bold one shows where the actual trigger occurs.



CAPTURE RARE PHENOMENA

Use glitch trigger settings to select width conditions that exclude events falling inside or outside of a selected width range. Only pulses less than or equal to, or greater than or equal to, this range will generate a trigger event. Waverunner initializes the timing for the width and restarts on the slope opposite the selected edge. You can select the same width values as those for glitch trigger.

1. Connect to Channel 1, for example, a signal whose multiple glitches have a low duty cycle and that cannot be seen using Edge trigger or Analog Persistence.

2. Press the button for  and set Coupling to match the source impedance.

3. Press  and then  to display a normal waveform. Viewing this signal during several captures would reveal the occasional glitch. The goal of the measurement is to catch this event by setting a trigger adapted to it.

4. Press TRIGGER  and then the button to select 

5. Press the button to  to display and set up the Glitch trigger menus.

Set up the trigger to eliminate nominal pulses of a particular width. Waverunner will then only trigger on those waveforms that do not have this pulse width.

6. Press the button to select **1** from the “trigger on” menu.

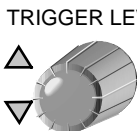
7. Turn  to adjust the trigger’s level to one division from the top of the pulse, for example.

8. Press the button to select **Pos** from the “at end of” menu, and **On** from the “width ≤” menu.

9. Turn the knob to set the “≤ width” value.

10. Press the button to select **On** from the “width ≥” menu, and turn the knob to set the ≥ width value.

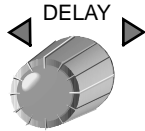

11. Turn  to set the trigger point close to mid-grid.

NORMAL

12. Press  to start triggering.

TIP: Use Analog Persistence to display a history of your exceptional pulse captures, such as the one at right.

Enhance your display still further by combining Exclusion trigger with Pass/Fail testing. The trigger speeds the acquisition of exceptional pulses, while the mask testing verifies the wave shape.

Store the waveform or print the screen display to document each pulse individually.

Display waveform parameter statistics under the grid for additional information on the key waveform parameters of these pulses. Use this new information to change the trigger setup to concentrate on acquiring pulses with more specific characteristics.

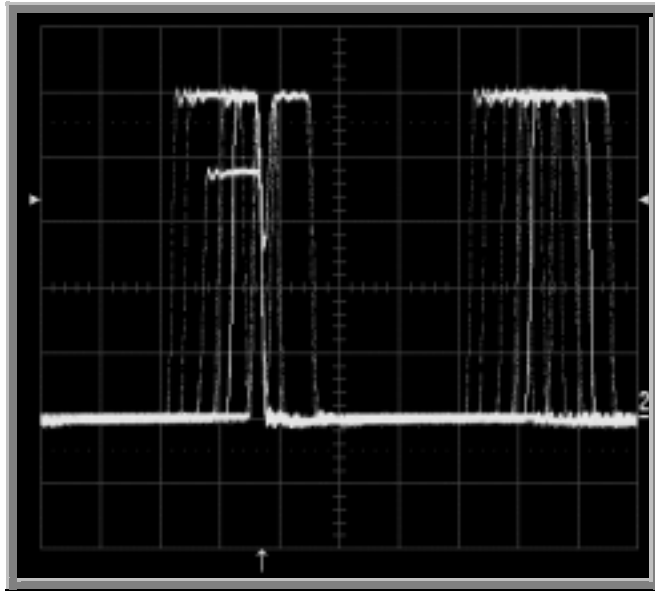

Exclusion trigger: Persistence display.

TO DETERMINE LEVEL, COUPLING, AND SLOPE

Level defines the source voltage at which the trigger circuit will generate an event (a change in the input signal that satisfies the trigger conditions). The selected trigger level is associated with the chosen trigger source.



Trigger level is specified in volts and normally remains unchanged when you change the vertical gain or offset. The amplitude and range of the trigger level are limited as follows:

±5 screen divisions with a channel as the trigger source

±0.5 V with EXT as the trigger source

±5 V with EXT/10 as the trigger source

None with LINE as the trigger source (zero crossing is used)

Coupling refers to the type of signal coupling at the input of the trigger circuit. As with the trigger level, you can select the coupling independently for each source. Change the trigger source and you may change the coupling. You can choose from these coupling types:

DC: All the signal's frequency components are coupled to the trigger circuit for high-frequency bursts or where the use of AC coupling would shift the effective trigger level.

AC: The signal is capacitively coupled; DC levels are rejected and frequencies below 50 Hz attenuated.

LF REJ: The signal is coupled through a capacitive high-pass filter network, DC is rejected and signal frequencies below 50 kHz are attenuated. For stable triggering on medium to high frequency signals.

HF REJ: Signals are DC coupled to the trigger circuit, and a low-pass filter network attenuates frequencies above 50 kHz. It is used for triggering on low frequencies.

Slope determines the direction of the trigger voltage transition used for generating a particular trigger event. You can choose a positive or negative slope. Like coupling, the selected slope is associated with the chosen trigger source.

TRIGGER ON INTERVALS

While Glitch trigger performs over the width of a pulse, Interval trigger performs over the width of an interval — the signal duration (the period) separating two consecutive edges of the same polarity: positive to positive or negative to negative. Use Interval trigger to capture intervals that fall short of, or exceed, a given time limit. In addition, you can define a width range to capture any interval that is itself inside or outside the specified range — an Exclusion trigger by Interval.

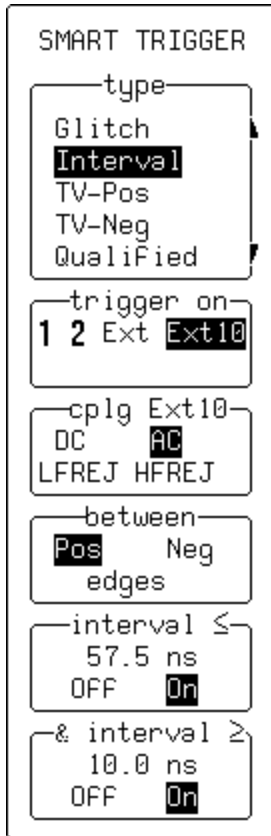

Use these menus to set up for triggering on an interval.



1. Select **Interval**.



2. Select the trigger source.



3. Select the coupling for the trigger source.



4. Place the trigger point on the positive or negative edge of the selected pulse.

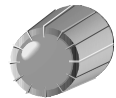

5. Select **On** to trigger if the pulse is less than or equal to the value set with the knob (range: 2.5 ns to 20 s). Use in combination with “width ≥.”



6. Select **On** to trigger if the pulse is greater than or equal to the value set with the knob (range: 2.5 ns to 20 s). Use in combination with “width ≤,” combined to target intervals within (“&”) a certain range if the “width ≤” value is greater than the “width ≥” value. **OR** in the menu indicates that intervals above or below this range will be targeted.

HOW INTERVAL TRIGGERS WORK



Interval Smaller: For this Interval Trigger, generated on a time interval smaller than the one selected, choose a maximum interval between two like edges of the same slope — positive, for example (Fig. 4).

The trigger is generated on the second (positive) edge if it occurs within the selected interval. Waverunner initializes and restarts the timing for the interval whenever the selected edge occurs. You can select an interval of between 10 ns and 20 s.

Trigger Source: Positive Slope



Trigger can occur



Generated Trigger



Figure 4. Interval Trigger that triggers when the interval width is smaller than the selected interval. The broken, upward-pointing arrow indicates a potential trigger, while the bold one shows where the actual trigger occurs — on the positive edge within the selected interval.

Interval Larger: For this Interval Trigger, generated on an interval larger than the one selected, select a minimum interval between two edges of the same slope (Fig. 5). Waverunner generates the trigger on the second edge if it occurs after the selected interval. The timing for the interval is initialized and restarted whenever the selected edge occurs. You can select intervals of between 10 ns and 20 s.

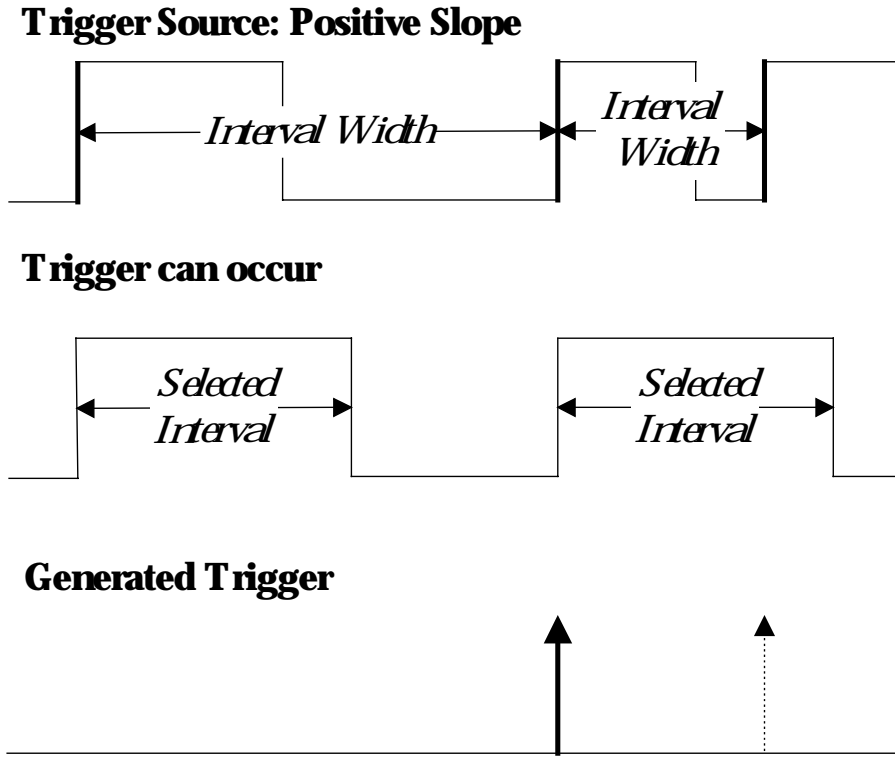
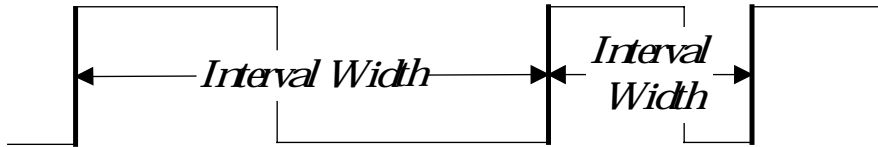

Figure 5. Interval Trigger that triggers when the interval width is larger than the selected interval. The broken upward-pointing arrow indicates a potential trigger, while the bold one shows where the actual trigger occurs — on the positive edge after the selected interval.

Interval Between Range: This Interval Trigger is generated whenever an interval between two edges of the same slope falls within a selected range (Fig 6). Waverunner initializes and restarts the timing for the interval whenever the selected edge occurs. You can select intervals of between 10 ns and 20 s.



Trigger Source: Positive Slope



Trigger can occur

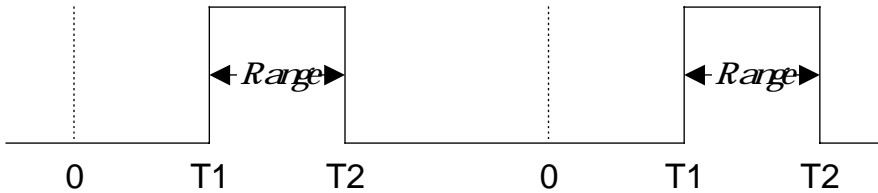

Generated Trigger



Figure 6. Interval Trigger that triggers when the interval falls within the selected range: T1=range's lower time limit; T2=range's upper limit. The broken upward pointing arrow indicates a potential trigger, while the bold one indicates where the actual trigger occurs — on the positive edge within the selected range.

QUALIFY A SIGNAL

Use a signal's transition above or below a given level — its validation — as an enabling (qualifying) condition for a second signal that is the trigger source. These are Qualified triggers. With State Qualified trigger, the amplitude of the first signal must remain in the desired state until the trigger occurs. While for Edge Qualified trigger the validation is sufficient and no additional requirement is placed on the first signal. A Qualified trigger can occur immediately after the validation or within a set time after it. Or it can occur following a predetermined time delay or number of potential trigger events. The time delay or trigger count is restarted with every validation.

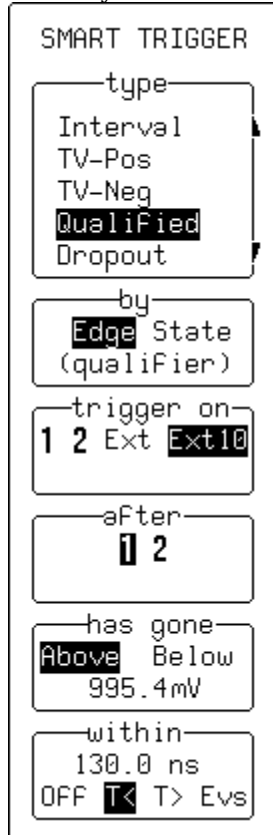

Use these menus to set up an Edge or State Qualified trigger.



1. Select **Qualified**.



2. Select **Edge** or **State** as the qualifier. (Set conditions such as the coupling, slope, and holdoff using the Edge trigger menus.)



3. Select the trigger source. This could be a channel, EXT, or EXT 10.



4. Select the qualifier source. This could be a channel, EXT or EXT 10, depending on your choice of trigger source.

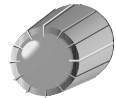

5. Turn to adjust the qualifier threshold, and press to determine whether the qualifier signal is valid once it "has gone" (Edge Qualified) or "goes and stays" (State Qualified) above or below that threshold.

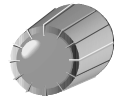

6. Specify the time limit ("within" **T<**) for accepting the trigger event. Or, specify the delay in time ("wait" **T>**) or number of trigger events ("wait" **Evs**) after a valid transition has occurred. A trigger can only be accepted after this delay. Any subsequent qualifier event restarts the count. The time value can be set in the range 10 ns–20 s. The trigger event count can be set in the range 1–99 999 999.

HOW QUALIFIED TRIGGERS WORK



State Qualified and Wait (Fig. 7) is determined by the parameters of *Time* or *Events*.

Time determines a delay from the start of the desired pattern. After the delay (timeout) and while the pattern is present, a trigger can occur. The timing for the delay is restarted when the selected pattern begins.

Events determines a minimum number of events of the trigger source. An event is generated when a trigger source meets its trigger conditions. On the selected event of the trigger source and while the pattern is present, a trigger can occur. The count is initialized and started whenever the selected pattern begins, and continues while the pattern remains. When the selected count is reached, the trigger occurs.

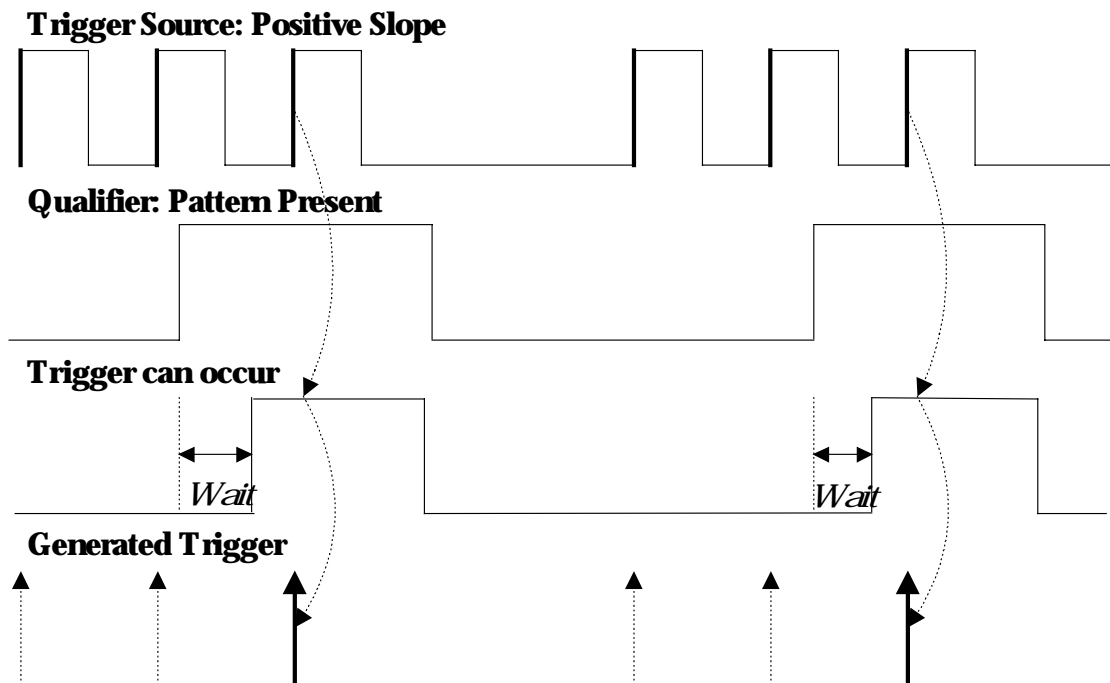

Figure 7. State Qualified and Wait: Trigger after timeout. The broken upward pointing arrows indicate potential triggers, while the bold arrows show where the actual triggers occurs.

Edge Qualified and Wait (Fig. 8) is also conditioned by either *Time* or *Events*:

Time determines a delay from the start of the desired pattern. After the delay (timeout) and before the end of the pattern, a trigger can occur. The timing for the delay is restarted when the selected pattern begins.

Events determines a minimum number of events for the trigger source. An event is generated when a trigger source meets its trigger conditions. A trigger can occur on the selected event of the trigger source and before the end of the pattern. The count is initialized and started whenever the selected pattern begins. It continues while the pattern remains. When the selected count is reached, the trigger occurs.

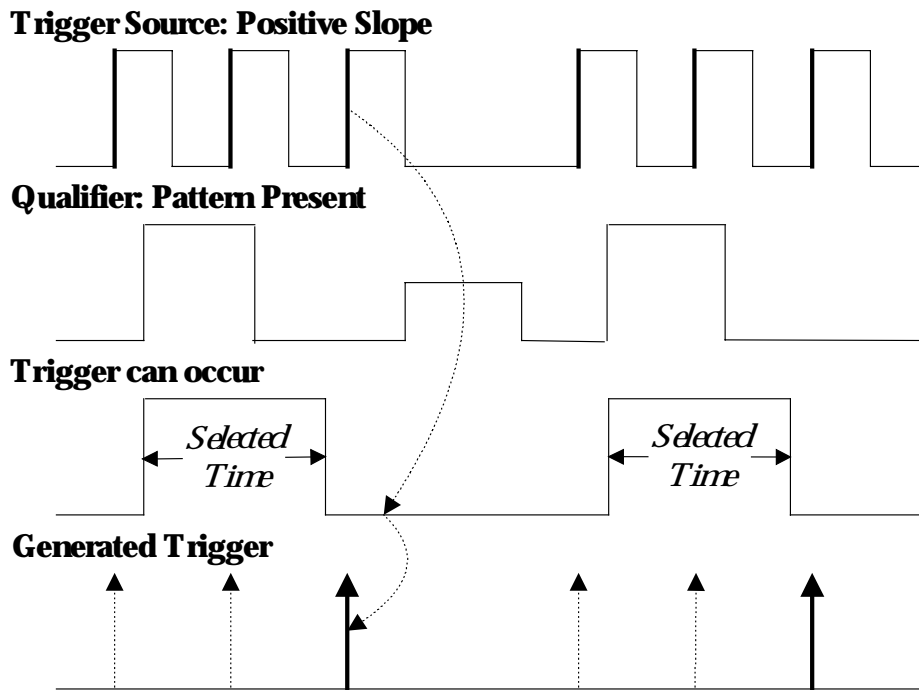
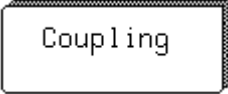



Figure 8. Edge Qualified and Wait: Trigger after timeout. The broken upward pointing arrows indicate potential triggers, while the bold ones show where the actual trigger occurs.



TRIGGER ON LOST SIGNALS

Use Dropout trigger whenever your signal disappears for a set period of time. The trigger is generated at the end of the timeout period following the “last” trigger source transition (Fig 9, page 105). Timeouts of between 25 ns and 20 s can be selected. Dropout trigger is used essentially for single-shot applications — usually with a pre-trigger delay.

1. Connect the signal to be measured to Channel 1.

2. Press the button for  and set Coupling to match the source impedance.

3. Press  twice to display the waveform. The following steps set the Dropout trigger to capture only the “last normal” period of the signal and transient signal.

4. Press TRIGGER  and then the button to select 

5. Press the button for  to display the menus shown on the next page.

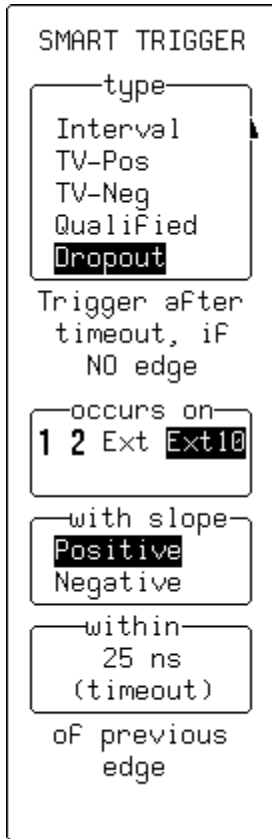

Use these menus to set up the Dropout trigger.



6. Select **Dropout**.

TIP: Use Dropout Trigger when viewing signals on more than one channel (you can view the signal characteristics on a channel other than the trigger source). To trigger the scope when a signal disappears, make the timeout longer than the signal period. The Waverunner will not trigger when the repetitive signal is active, because two successive edges occur in a single period.



7. Select the trigger source.



8. Select the slope.

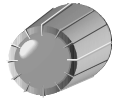

9. Turn to set the timeout (25 ns by default).

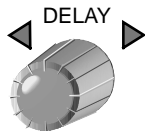
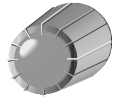

10. Turn to set the trigger point to allow display of the signal's "last normal" period.

When the signal disappears, the Waverunner triggers.

HOW DROPOUT TRIGGER WORKS

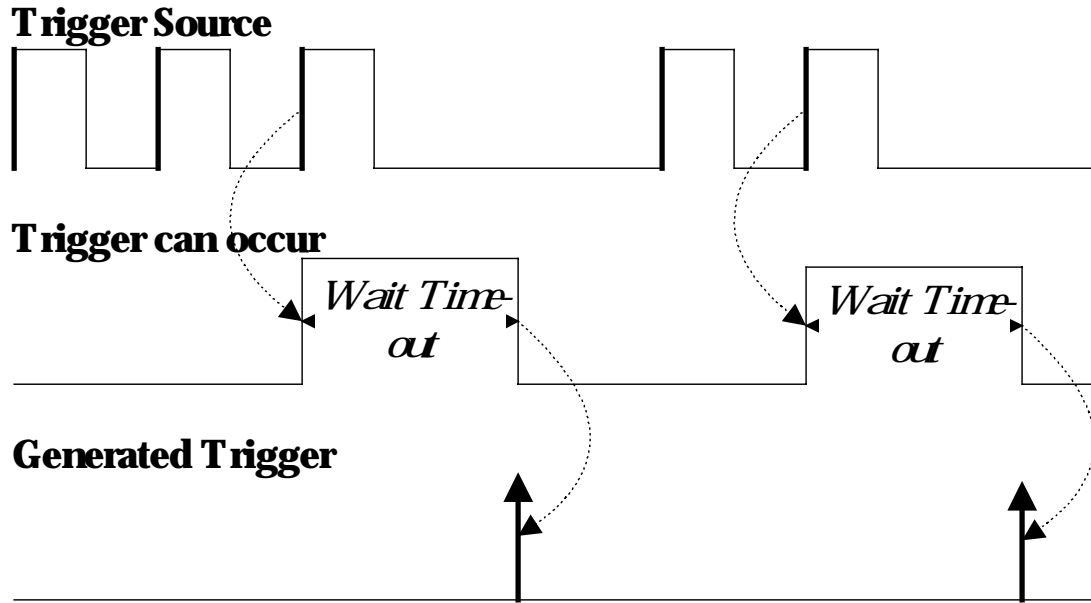
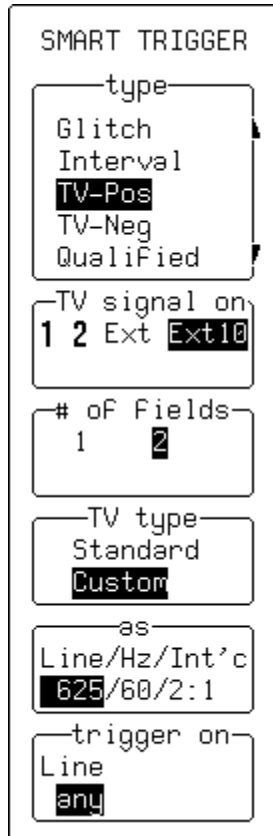

Figure 9. Dropout Trigger: occurs when the timeout has expired. The bold upward-pointing arrows show where the trigger occurs.

TRIGGER ON TV SIGNALS

Waverunner's TV triggers provide stable triggering on standard or custom composite video signals. Use them on PAL, SECAM, or NTSC systems. A composite video signal on the trigger input is analyzed to provide a signal for the beginning of the chosen field — “any,” “odd,” or “even” — and for a signal at the beginning of each line. The field signal provides the starting transition, and the beginnings of line pulses are counted to allow the final trigger on the chosen line. Each field, the number of fields, the field rate, interlace factor, and number of lines per picture must be specified — although there are standard settings for the most common types of TV signals. TV Trigger can also function in a simple any-line mode.



Use these menus to set up a TV trigger.



1. Select **TV-Pos** or **TV-Neg** polarity.



2. Select the trigger source.



3. Specify the number of fields or define the field number. For the LT364 series, you have the choice of **1**, **2**, **4**, or **8** fields. For all other models: **1**=odd, **2**=even.



4. Select **Standard** or **Custom** TV decoding



5. **Standard:** Select either **625/50/2:1** (PAL, SECAM) or **525/60/2:1** (NTSC) standard. **Custom:** Specify the number of lines and cycles, and set the interlacing factor for non-standard TV signals.



6. Define the line on which to trigger with the knob: **any** allows you to trigger on any line number.



TO USE TV TRIGGERS

Most TV systems have more than two fields. Waverunner's enhanced field counting capability (FIELD LOCK) allows you to trigger consistently on a chosen line within a signal field.



*The field numbering system is relative: the oscilloscope will trigger on odd or even fields for LT34x, LT32x, and LT22x scopes. For the LT364 series, select **1**, **2**, **4**, or **8** fields.*

625/50/2:1 (PAL and SECAM systems): *Use for most of the standard 50-field signals. The lines can be selected in the range 1 to 626 where line 626 is identical to line 1.*

525/60/2:1 (NTSC systems): *Use for standard 60-field NTSC signals. The lines can be selected in the range 1 to 1051, where line 1051 is identical to line 1.*

***/50/*, */60/*:** *For maximum flexibility, no line-counting convention is used. The line count should be thought of as a line-synchronizing pulse count. It includes the transitions of the equalizing pulses. In certain extreme cases, the field transition recognition will no longer work, and only the "any line" mode will be available.*

The enhanced field counting capability CANNOT be used for RIS acquisitions.

PATTERN TRIGGER (LT364 SERIES ONLY)

Pattern Trigger enables triggering on a logical combination of the five inputs CH 1, CH 2, CH 3, CH 4, and EXT. This combination, called a pattern, is defined as the logical AND of trigger states. A trigger state is either high or low: high when a trigger source is greater than the trigger level (threshold) and low when less than it. For example, a pattern could be defined as present when the trigger state for CH 1 is high, CH 2 is low, and EXT is irrelevant (X or don't care). If any one of these conditions is not met, the pattern state is considered absent. Holdoff limits from 10 ns to 20 s or from 1 to 99999999 events can be selected.

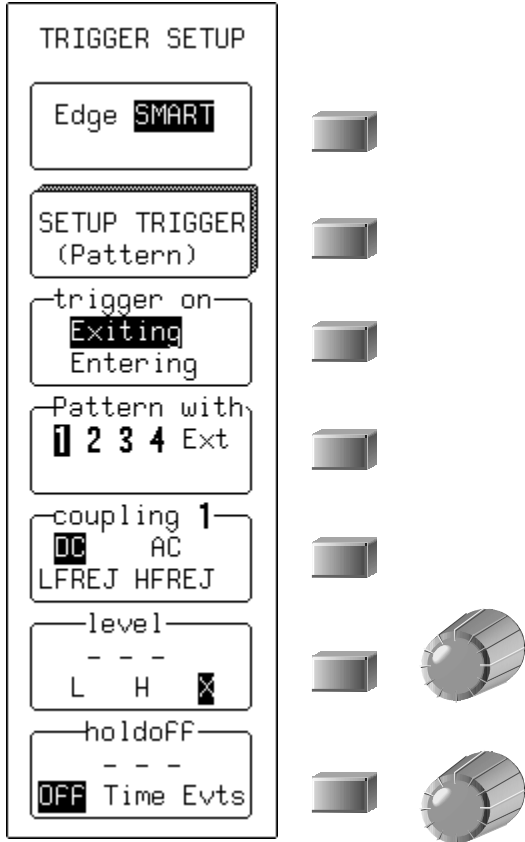

Pattern Applications

Pattern Trigger can be used in digital design for the testing of complex logic inputs or data transmission buses.

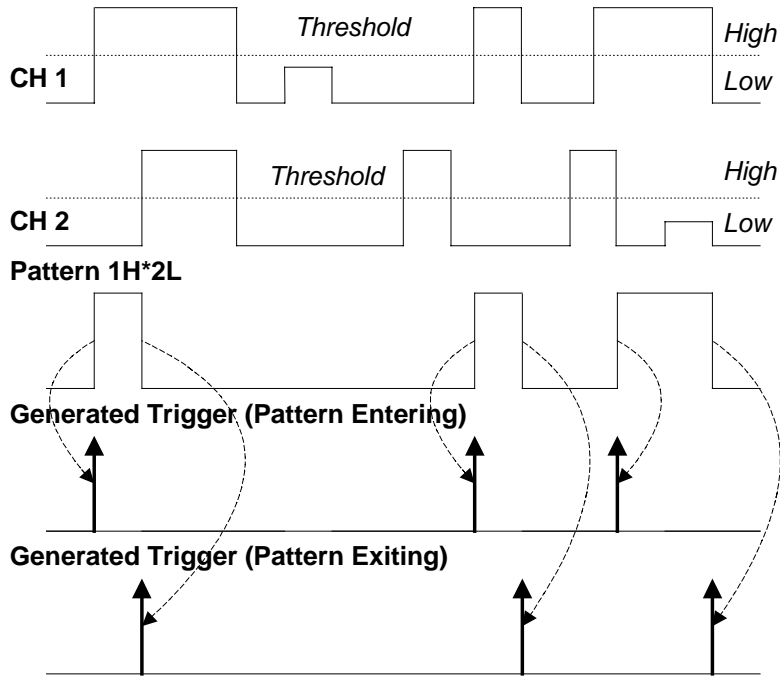

Pattern Trigger: Triggers when all pattern conditions are met. Bold arrows pointing upward show where triggers occur. Information summarizing the pattern setup is displayed.

```

Enter 1H*3H*4L*EL   E AC 500mV 1MΩ
1 DC 1.004 V        - - -
3 AC 2.49 V         4 AC 2.50 V
    
```

More About Pattern Trigger

Once the pattern is defined, one of two transitions can be used to generate the trigger. When the pattern begins, called *entering* the pattern, a trigger can be generated. Alternatively, a trigger can be generated when the pattern ends, called *exiting* the pattern.

With pattern triggering, as in single source, either of these qualifications can be selected: Holdoff for 10 ns to 20 s, or Holdoff for up to 99 999 999 events.

When set to Pattern Trigger, the oscilloscope always checks the logic AND of the defined input logic states. However, with the help of de Morgan's theorem, the pattern becomes far more generalized.

Consider the important example of the Bi-level or Window Pattern Trigger. Bi-level implies the expectation of a single-shot signal's going in either direction outside a known amplitude range. To set up a Bi-level Pattern trigger, connect the signal to two inputs: Channels 1 and 2, or any other pair that can be triggered on. For example, the threshold of CH 1 could be set to +100 mV and that of CH 2 at -200 mV. The Bi-level Trigger will occur if the oscilloscope triggers on CH 1 for any pulse greater than +100 mV, or on CH 2 for any pulse less than -200 mV. For improved precision, the gains of the two channels should be at the same setting

In Boolean notation we can write:

$$\text{Trigger} = \text{CH 1} + \overline{\text{CH 2}}$$

that is, trigger when entering the pattern CH 1 = high OR CH 2 = low

By de Morgan's theorem this is equivalent to:

$$\text{Trigger} = \overline{\overline{\text{CH 1}} \cdot \text{CH 2}}$$

that is, trigger when exiting the pattern CH 1 = low AND CH 2 = high. This configuration can be easily programmed.

The possibility of setting the threshold individually for each channel extends this method so that it becomes a more general Window Trigger: in order to trigger the input pulse amplitude must lie within or outside a given arbitrary window

Pattern Trigger has been designed to allow a choice of the trigger point. By choosing *1L*2H entering* the trigger will occur at the moment the pattern 1L*2H becomes true.



BLANK PAGE

CHAPTER NINE: *Display More*

Chapter 3 showed how to set up the display and use persistence. Now learn how to get more from your display.

In this chapter, see how

Analog Persistence works

To use advanced color management tools

To change your palettes and pick colors

To set up XY display

To use cursors in XY display

Transform Your Vision

ANALOG
PERSIST

Press the green  button and transform your vision of the waveform. With the brightness levels of a single color, the Waverunner Analog Persistence feature shows relative signal intensities “three dimensionally” to reveal signal evolution over time. It offers you an *analog* view of the waveform with all the advantages of a digital oscilloscope. Color Graded persistence works in a similar way using a color spectrum to map signal intensity. Both Waverunner persistence modes are infinite or variable with decay over time.

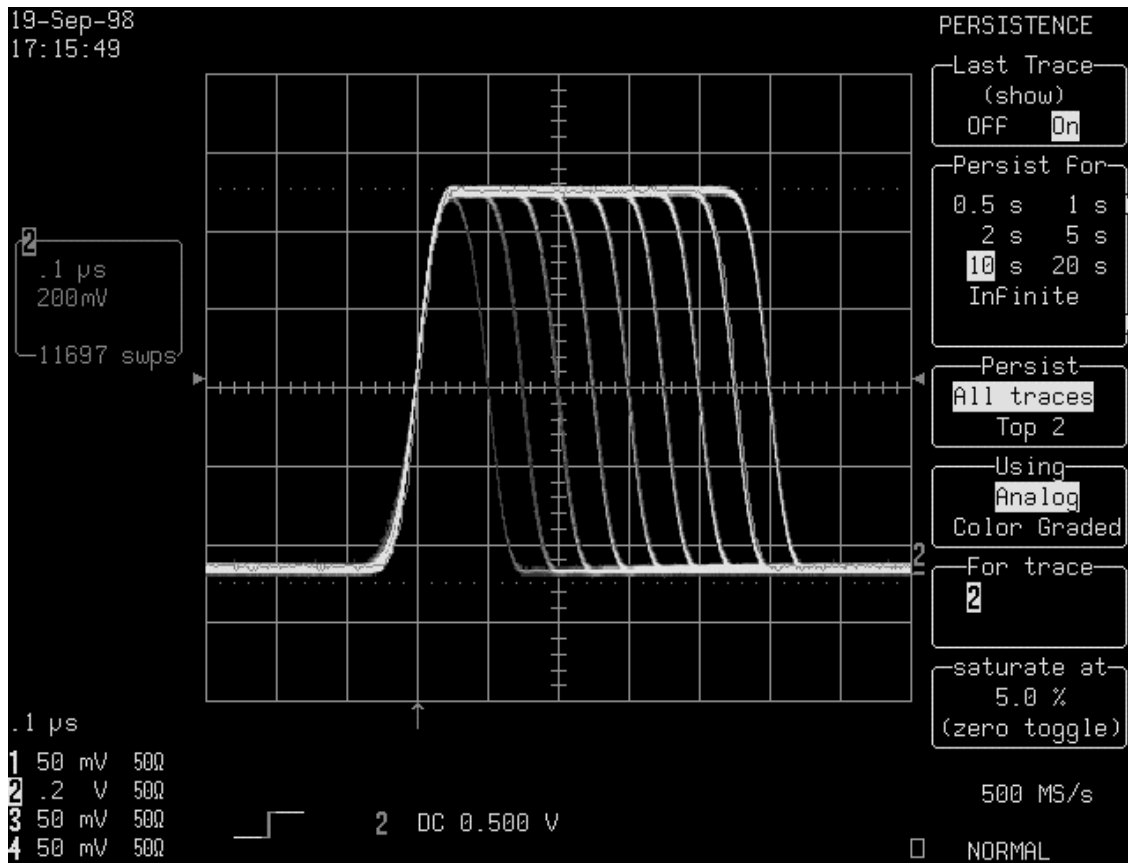

Analog Persistence display of a signal with elements of a variable frequency of occurrence.

HOW ANALOG PERSISTENCE WORKS

LeCroy's Analog Persistence feature offers the advantages of analog display in a DSO (Digital Storage Oscilloscope). The display looks like analog and is fast, too. But it has the data manipulation, flexibility, and statistical analysis capabilities only found in a digital instrument.



With traditional analog instruments, data manipulation and the direct comparison of acquisitions is practically impossible. Statistical analysis is difficult to perform too. Nevertheless, analog does have certain advantages. Because there is no need for analog-to-digital conversion, the speed of the analog scope is limited only by the bandwidth of its electronics: signals are monitored almost continuously. The standard DSO must capture signals across the time period allowed by the size of its acquisition memory, then process and display their representation. The time needed to process the previous acquisition normally limits DSO speed.

But the Analog Persistence digital oscilloscope is different. It decouples data accumulation from display, accumulating and displaying new data more quickly. Moreover, the persistence is variable.

The display is generated by repeated sampling of the amplitudes of events over time, and the accumulation of the sampled data into three-dimensional display maps. These maps create an analog-style display. User-definable persistence duration can be used to view how the maps evolve proportionally over time. Statistical integrity is preserved because the duration, or decay, is proportional to the persistence population for each amplitude or time combination in the data. In addition, the Analog Persistence scope provides user definable, post-acquisition saturation control of the maps, allowing you to draw detail from the display.

When you select "Analog" from the Using persistence menu, each channel and its associated persistence data map are assigned a single color. As a persistence data map develops, different shades of its color are assigned to the population ranges between a minimum and a maximum population. The maximum population automatically gets the brightest shading, the zero or smallest population gets the darkest shading or the background color, and the population ranges between zero and the maximum population gets the shades in between these.

The information in the lower populations, or down at the noise level (random transients rather than dominant signals) could interest you more than the rest. The Analog Persistence view highlights the distribution of data so that you can more easily examine it in detail.

You can select a saturation level or population as a percentage of the maximum population. All populations above the saturation population are then assigned the brightest shade: that is, they are saturated. At the same time, all populations below the saturation level are assigned the remaining shades from brightest down to darkest.

Data populations and their displayed shades are dynamically updated as data from new acquisitions is accumulated.

TO DISPLAY COLOR-GRADED PERSISTENCE

Color-Graded persistence follows the same principles as the Analog Persistence feature, but uses not one, but many, colors to map signal intensity. When you select "Color Graded" from the Using persistence menu, instead of the brightness of a single color as in the Analog Persistence view, the Waverunner uses a color spectrum from red through violet to display persistence.

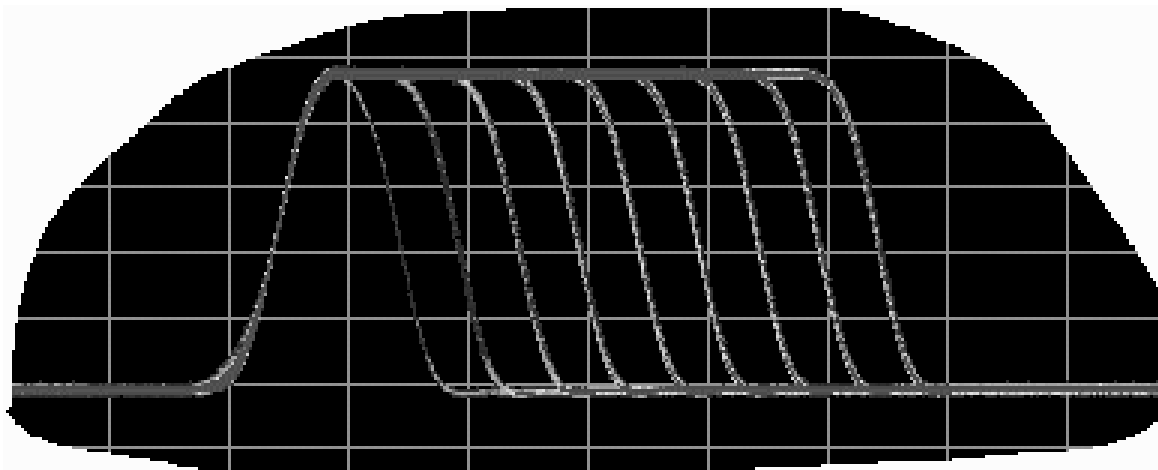

The same waveform as that shown on page 113 displayed using Color-Graded persistence shows the persistence waveform in a spectrum of colors rather than shades of a single color.

“Paint” Your Display

Personalize your Waverunner display — your “canvas” — by choosing from a range of tools, techniques, and color schemes.

1. In the DISPLAY SETUP group (see Chapter 3, “Visualize Your Signal”), press the button for “More Display Setup” to access these menus.

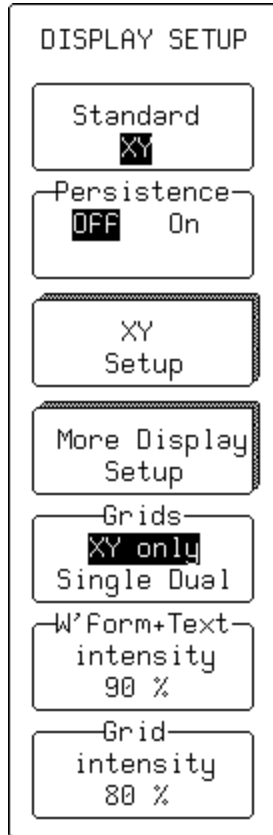

2. Use them to change color schemes and choose advanced color management tools.



To activate the screen saver. See “First Things.”



To select either a pre-set, default (**1-6**) or customized (**U1-U4**) color scheme. Choose a custom scheme; the menu below appears. Also selects a scheme for copying to. See next page.



To access the CHANGE COLORS menus. See next page.



To turn Full Screen **On** and expand the grid display to fill the entire screen, **Off** to return to the normal display.



To select **Opaque** or **Transparent** mode, in which objects are always visible. Overlapping regions are distinguished by a new and unique color.



To activate the Measure Gate function. Objects of lesser interest given the color “neutral” will be automatically relegated to the area outside a region. Objects *inside* this measurement-gate region are thus highlighted.

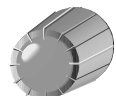

To show data, or sample, points either as **Normal** or **Bold**.

RETURN



In Full Screen, to remove all menus from the screen. The menus will reappear when any darker, labeled, front panel button is pressed.

CHANGE YOUR PALETTE

3. Press the button for “Change Colors” and use these menus to do the following:

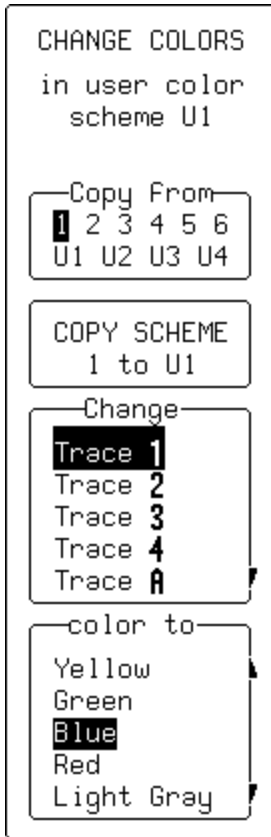

Create your own color scheme; assign colors to traces, grids, or any other on-screen object; or copy a default scheme into a custom one to make personalizing quicker and easier.



To select one of the a pre-set, default (1-6) or customized (U1-U4) color schemes, and copy it to another User scheme. This creates a palette that can then be more easily personalized.



To copy the scheme selected in the menu above to the User color scheme selected in the Color Scheme menu shown on the previous page.



To select the displayed object to be assigned a color using the menu below (see next page).

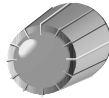

For selecting the color to be assigned to the object selected in the “Change” menu (see page 119).



RETURN



To return to the MORE DISPLAY menus.

TO ASSIGN COLORS TO ON-SCREEN OBJECTS



Background — background color of the entire display area

Trace 1...4 — color assigned to traces displaying Channel 1, 2, or 3 or 4

Trace A...D — color assigned to Trace A, B, C, or D

Grid — default color of the grid

Text — color assigned to menus, acquisition status and non-single source measurements

Cursors — color assigned to cursors

Warnings — color assigned to error and warning messages

Neutral — color designated as neutral (can be any in user palettes) for measure-gate-region highlighting

Overlays — color assigned to the menus overlaid on the grid when in Full Screen mode.

To CHOOSE COLORS

Choose from this gallery of colors for your U1, U2, U3, and U4 custom palettes.



TIP: Personalize your color schemes: for traces, grids, text and menus, cursors, neutral color, background, warnings, and overlays. See the previous page.



Set Up XY Display

XY display is for traces that have the same time- or frequency-span (time/div), expressed using the same horizontal unit, in seconds or Hertz. The XY display offers three special grid styles: XY only, XY Single and XY Dual, illustrated on the next page.

DISPLAY

1. Press  for the DISPLAY SETUP menus.
2. Press the button to select **XY** from the top menu.

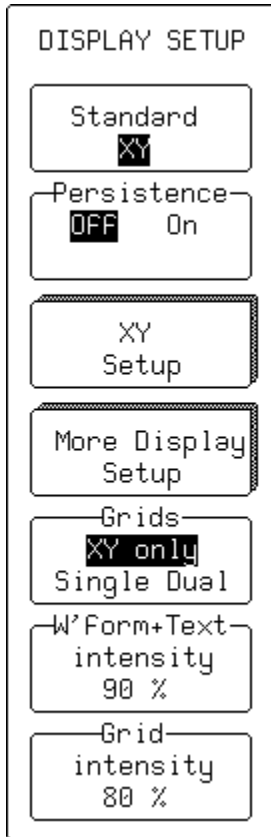

3. Use these menus to set up your XY display, and to access other display setup menus if desired.



To select "Standard" or **XY**.



To turn persistence on or off. Or press 

ANALOG
PERSIST



To access XY persistence menus: for choosing Analog or Color-Graded persistence, and persistence saturation in XY display.



To access more display setup menus. See page 116.



To select grid style and number. See next page.

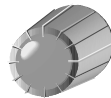

To adjust waveform and text brightness, using the knob. To return to the default intensity, press the button.

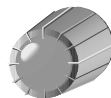

To adjust grid intensity using the knob only. Grids can be brightened, or blended with displayed traces. To return to the default intensity, press the button.

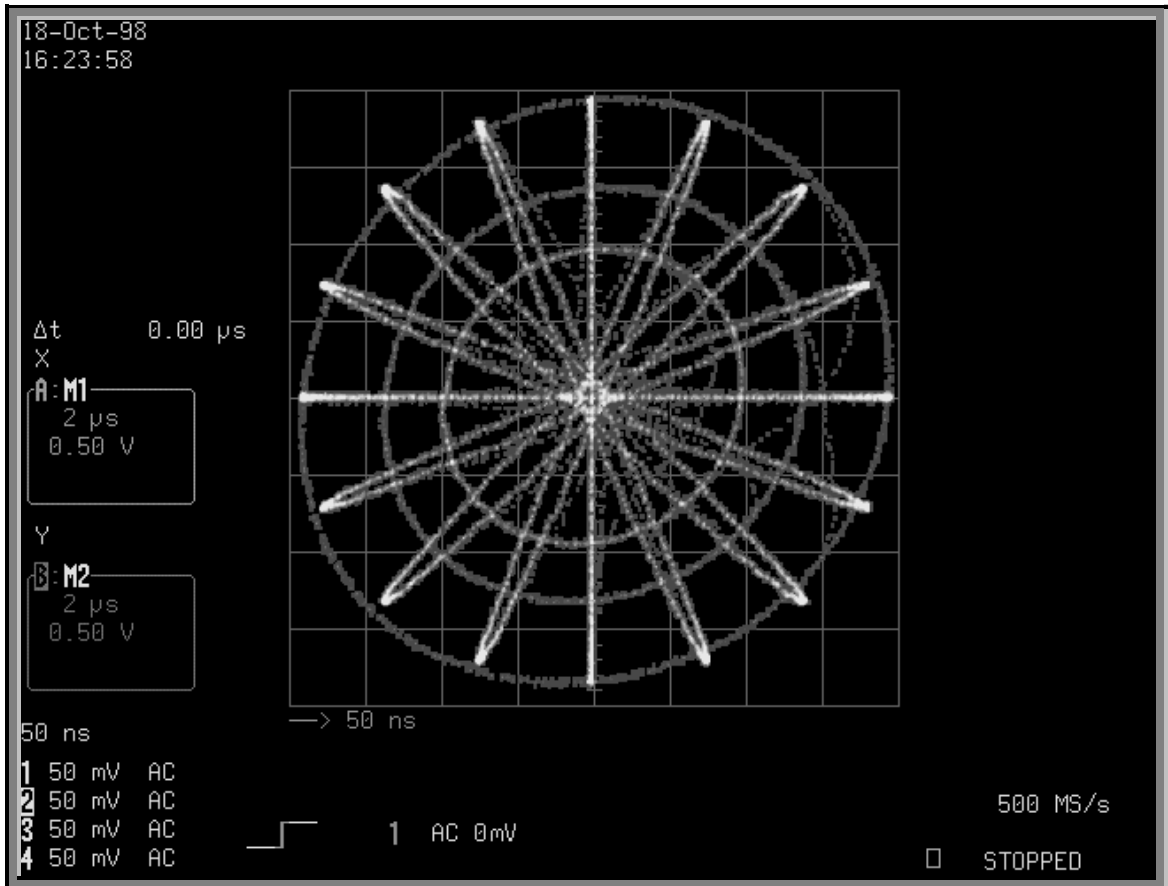

Analog Persistence vector diagram on XY Only grid. Below: XY Only, Single and Dual grids.

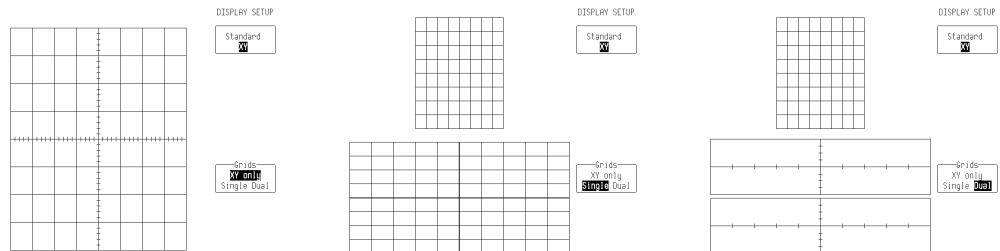

TO USE CURSORS IN XY DISPLAY

Cursors are different in XY display (see Chapter 4, “Choose a Measure Tool,” for cursors in general).



Absolute Amplitude cursors are horizontal and vertical bars that can be moved up and down and from side to side across the screen. XY Relative Amplitude cursors are pairs of bars that move in the same way.

Absolute and Relative Time cursors behave in XY as they do in Standard display.

Combinations of the amplitude values are shown on the left-hand side of the grid in the following top-to-bottom order:

“ ΔY value / ΔX value”: **Ratio**

*“ $20 * \log 10$ (ratio)”:* **Ratio in dB units**

*“ ΔY value * ΔX value”:* **Product**

“ $\phi = \arctan (\Delta Y / \Delta X)$ range $[-180^\circ$ to $+180^\circ]$ ”: **Angle (polar)**

*“ $r = \sqrt{\Delta X * \Delta X + \Delta Y * \Delta Y}$ ”:* **Radius (distance to origin).**

The definition of ΔX and ΔY depends on which cursor you use. The table below shows how ΔX and ΔY are defined for each type of cursor measurement.



XY CURSORS					
	A_{Abs}	A_{Rel}	T_{Abs}		T_{Rel}
			$Org = (0,0)$	$Org = V_{XOffset}$ $V_{YOffset}$	
ΔX	$V_{XRef} - 0$	$V_{XDif} - V_{XRef}$	$V_{XRef} - 0$	$V_{XRef} - V_{XOffset}$	$V_{XDif} - V_{XRef}$
ΔY	$V_{YRef} - 0$	$V_{YDif} - V_{YRef}$	$V_{YRef} - 0$	$V_{YRef} - V_{YOffset}$	$V_{YDif} - V_{YRef}$

Where the terms signify:

A_{Abs} : Absolute Amplitude cursors

A_{Rel} : Relative Amplitude cursors

T_{Abs} : Absolute Time cursors

T_{Rel} : Relative Time cursors

Org : Origin

V_{Xref} : Voltage of the Reference cursor on the X trace

V_{Yref} : Voltage of the Reference cursor on the Y trace

V_{Xdif} : Voltage of the Difference cursor on the X trace

V_{Ydif} : Voltage of the Difference cursor on the Y trace



CHAPTER TEN: *Use Advanced Math Tools*

You have seen how to use Waverunner math tools. Now look deeper into waveform processing and apply the scope's advanced math features.

In this chapter, see how

To process extrema waveforms

To perform enhanced resolution filtering

To rescale your waveform

To do more with FFT

To use a math function

To plot parameter trends

Compute Extrema Waveforms

Use extrema to view a trace envelope of numerous sweeps. Your Waverunner scope repeatedly compares the maxima (roof) and minima (floor) values of new waveforms with those of already accumulated extrema records. Whenever the oscilloscope finds that a given data point of a new waveform is greater than the corresponding roof record value, or less than the floor record value, it replaces that record value with the new one. The Waverunner thus accumulates the maximum and the minimum envelope of all waveform records.

1. Press **1** to select CHANNEL 1 and display the Waverunner basic menus.

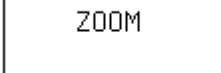
2. Press the button to 

3. Press **A** to select and set up Trace A.

3. Press the button for 

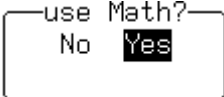
5. Press the button to select  and display the SETUP OF A menus.

6. Then press the button to select "**Extrema**" from the Math Type menu.

7. Press the button to select 

TIP: You can change the view of the envelope at anytime without affecting the accumulated data.

Envelope shows the entire envelope, while **Floor** and **Roof** show only the lower and upper parts of the envelope. Changing these limits will not restart the analysis.

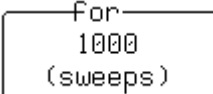
8. Turn the upper knob to set the number of sweeps: 

9. Press the button to select the source trace:

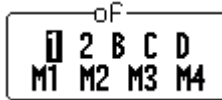

TO DO EXTREMA

Your Waverunner scope will stop accumulating whenever the selected maximum number of sweeps is reached. You can interrupt this process by changing the trigger mode from NORMAL to STOP (by pressing the STOP button), or by turning off the function trace. A cumulation will continue when you perform the reverse action.



Reset the currently accumulated extrema waveform by either pressing CLEAR SWEEPS, or changing a parameter such as gain, offset, coupling, trigger condition, or your timebase or bandwidth limit. Waverunner displays the number of currently accumulated waveforms in the displayed trace label of the zoom trace on which the extrema function is performed. You can display roof and floor records either individually or together.

Whenever the maximum number of sweeps is reached, you can accumulate an even larger number simply by changing the value in the SETUP for menu. However, leave the other parameters unchanged, or the calculation will be restarted.

TIP: Waverunner avoids being slowed down by computing a particular math function only when that function's trace is turned on. Despite this, waveform processing can take some time when there are many data points. Cut this delay by limiting the number of data points used in the computation. Waverunner will process the entire waveform by taking every nth point — where n depends on the timebase and the desired maximum number of points. The first point taken is always the data value at the left-hand edge of the display.



Rescale and Assign Units

This advanced math tool allows you to apply a multiplication factor (a), and additive constant (b), to your waveform. You can do it in the unit of your choice, depending on the type of application.

1. Follow the steps for setting up to do math on Trace A, B, C or D.
2. Press the button to select **Rescale** from the Math Type menu.
3. Select **a** or **b** from the next menu, below Math Type.
4. Press the button to select the mantissa, exponent, or number of digits; turn the knob to set its value.
5. If you wish, go back and select [**units**]. A new menu, called “units =” will then appear and allow you to define one of a wide range of units for your chosen value, including Amps, Celsius, Hertz, decibels, Kelvin, Ohms, Volts, and Watts.

6. Press the button to select the source trace for filtering:

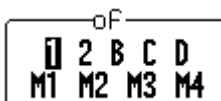

TO DO AVERAGING: SUMMED VS CONTINUOUS (OPTION)

Summed Averaging is the repeated addition, with equal weight, of successive source waveform records. If a stable trigger is available, the resulting average has a random noise component lower than that of a single-shot record. Whenever the maximum number of sweeps is reached, the averaging process stops.



A n even larger number can be accumulated simply by changing the number in the menu. However, the other parameters must be left unchanged or a new averaging calculation will be started. You can interrupt the averaging by changing the trigger mode from NORM to STOP, or by turning off the active trace. Waverunner resumes averaging when you perform the opposite action to these. Reset the accumulated average by pushing the CLEAR SWEEPS button or changing an acquisition parameter such as input gain, offset, coupling, trigger condition, timebase, or bandwidth limit. The number of current averaged waveforms of the function, or its zoom, is shown in the displayed trace label. When summed averaging is performed, the display is updated at a reduced rate — about once every 1.5 s — in order to increase the averaging speed (points and events per second).

***Continuous Averaging** is the repeated addition, with unequal weight, of successive source waveforms. It is particularly useful for reducing noise on signals that drift very slowly in time or amplitude. The most recently acquired waveform has more weight than all the previously acquired ones: the continuous average is dominated by the statistical fluctuations of the most recently acquired waveform. The weight of ‘old’ waveforms in the continuous average gradually tends to zero (following an exponential rule) at a rate that decreases as the weight increases.*

Enhance Resolution

ERES (Enhanced Resolution) filtering increases vertical resolution, allowing you to distinguish closely spaced voltage levels. Waverunner ERES is similar to smoothing the signal with a simple, moving-average filter. However, it is more efficient, both in terms of bandwidth and pass-band. Use ERES on single-shot waveforms, or where the data record is slowly repetitive — when you can't use averaging. Use it to reduce noise when your signal is noticeably noisy, but you don't need to perform noise measurements. Use it, too, when you perform high-precision voltage measurements: zooming with high vertical gain, for example.

1. Follow the steps for setting up to do math on Trace A, B, C, or D.

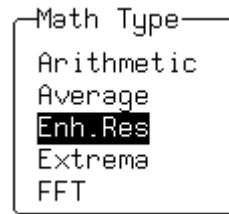

2. Then press the button to select **Enh. Res** from the Math Type menu:

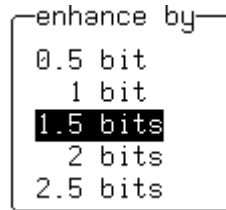

3. Press the button to select 1.5 bits, for example, from

This menu allows you to choose a filter that will enhance the resolution of the displayed signal by from one to three bits, in steps of 0.5 bits.

4. Press the button to select the source trace for filtering:

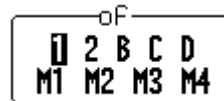

Result: See illustration next page.

TIP: Depending on your sampling speed, Waverunner digital filters can affect bandwidth. If you need bandwidth at slow timebases, use Averaging with repetitive sampling.

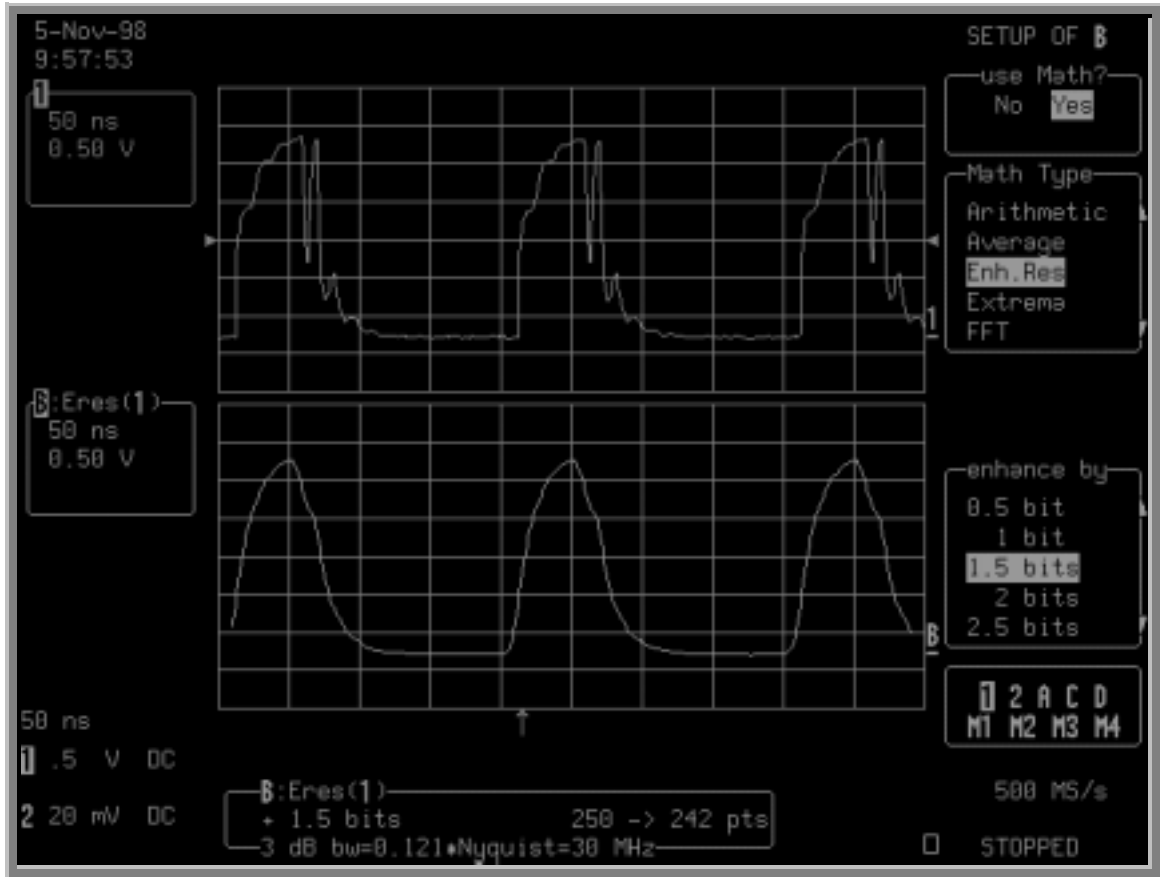

The glitch in the waveform displayed on the top grid has been clearly eliminated by ERES: the result is the waveform on the lower grid. Trace B's label indicates this as the filtered waveform. And the information field below the grids tells you that Trace B is an ERES function of Channel 1, that the waveform has been enhanced by 1.5 bits, and that filtering has reduced the number of points from 250 to 242 (see NOTE on page131) and the bandwidth to 30 MHz.

HOW WAVERUNNER ENHANCES RESOLUTION

The Waverunner's enhanced resolution feature improves vertical resolution by a fixed amount for each filter. This real increase in resolution occurs whether or not the signal is noisy, or your signal is single-shot or repetitive. The signal-to-noise ratio (SNR) improvement you gain is dependent on the form of the noise in the original signal. The enhanced resolution filtering decreases the bandwidth of the signal, filtering out some of the noise.



PART TWO: LOOKING DEEPER

The Waverunner's constant phase FIR (Finite Impulse-Response) filters provide fast computation, excellent step response in 0.5 bit steps, and minimum bandwidth reduction for resolution improvements of between 0.5 and 3 bits. Each step corresponds to a bandwidth reduction of a factor of two, allowing easy control of the bandwidth resolution trade-off. The parameters of the six filters are given in the following table.

RESOLUTION INCREASED BY	-3 DB BANDWIDTH (\times NYQUIST)	FILTER LENGTH (SAMPLES)
0.5	0.5	2
1.0	0.241	5
1.5	0.121	10
2.0	0.058	24
2.5	0.029	51
3.0	0.016	117

With low-pass filters, the actual SNR increase obtained in any particular situation depends on the power spectral density of the noise on the signal.

The improvement in SNR corresponds to the improvement in resolution if the noise in the signal is white — evenly distributed across the frequency spectrum.

If the noise power is biased towards high frequencies, the SNR improvement will be better than the resolution improvement.

The opposite may be true if the noise is mostly at lower frequencies. SNR improvement due to the removal of coherent noise signals — feed-through of clock signals, for example — is determined by the fall of the dominant frequency components of the signal in the passband. This is easily ascertained using spectral analysis. The filters have a precisely constant zero-phase response. This has two benefits. First, the filters do not distort the relative position of different events in the waveform, even if the events' frequency content is different. Second, because the waveforms are stored, the delay normally associated with filtering (between the input and output waveforms) can be exactly compensated during the computation of the filtered waveform.

The filters have been given exact unity gain at low frequency. Enhanced resolution should therefore not cause overflow if the source data is not overflowed. If part of the source trace were to overflow, filtering would be allowed, but the results in the vicinity of the overflowed data — the filter impulse response length — would be incorrect. This is because in some circumstances an overflow may be a spike of only one or two samples, and the energy in this spike may not be enough to significantly affect the results. It would then be undesirable to disallow the whole trace.

The examples on the following page illustrate how you might use the Waverunner's enhanced resolution function.

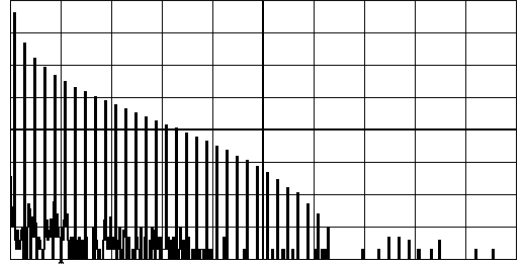
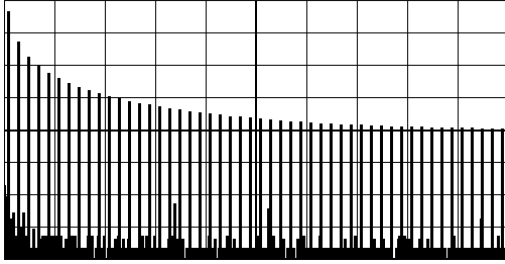

In low-pass filtering: The spectrum of a square signal before (above left) and after (above right) enhanced resolution processing. The result clearly illustrates how the filter rejects high-frequency components from the signal. The higher the bit enhancement, the lower the resulting bandwidth.

To increase vertical resolution: In the example at right, the lower (“inner”) trace has been significantly enhanced by a three-bit enhanced resolution function.

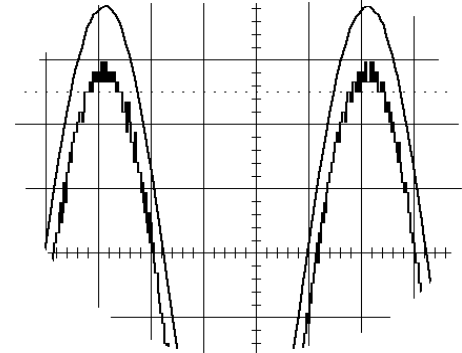

To reduce noise: The example below shows enhanced resolution of a noisy signal. The original trace (below left) has been processed by a two-bit enhanced resolution filter. The result (below right) shows a “smooth” trace, where most of the noise has been eliminated.

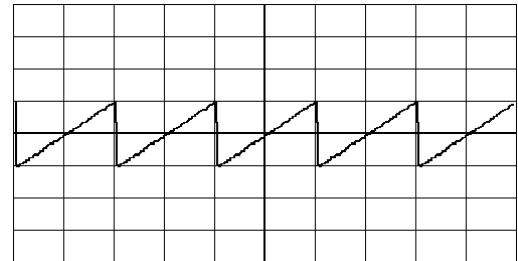
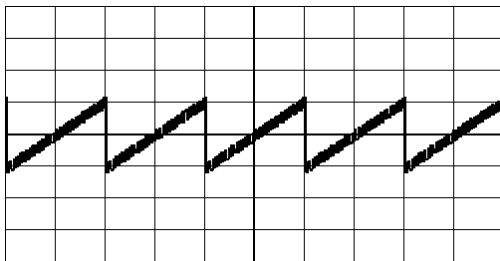

NOTE: Enhanced resolution can only improve the resolution of a trace; it cannot improve the accuracy or linearity of the original quantization. The pass-band will cause signal attenuation for signals near the cut-off frequency. The highest frequencies passed may be slightly attenuated. Perform the filtering on finite record lengths. Data will be lost at the start and end of the waveform; the trace will be slightly shorter after filtering. The number of samples lost is exactly equal to the length of the impulse response of the filter used — between two and 117 samples. Normally this loss — just 0.2% of a 50 000 point trace — is not noticed. However, you might filter a record so short there would be no data output. In that case, however, the Waverunner would not allow you to use the ERES feature.

Do More with FFT

In Part One (Chapter 5, “Use Math Tools”) we looked at how to use Fast Fourier Transform (FFT) to display and measure signals in the frequency domain. Now see how to use the optional FFT Average feature, and how to set up an FFT span to improve resolution. Valuable hints on how to get even more from this tool are also given here.

DO FFT AVERAGE

1. Follow the steps for setting up to do math on Trace A, B, C, or D.
2. Press the button to select **FFT AVG** from the Math Type menu.
3. Press the button to select an FFT function to average. Select **Power Spect**, for example, and you can define a function as the power average of FFT spectra, computed by another FFT function.

CLEAR
SWEEPS

4. Press  to reset FFT average and show the number of currently accumulated waveforms in the displayed trace field of the math trace or its zoom.

When FFT or FFT Averaging is used, the memory status field beneath the grid shows the parameters of the waveform descriptor.

C:PS(AVGP(B))
Power Spectrum 10000 -> 2500 pts

DO ADDITIONAL PROCESSING

You can perform other math and waveform processing functions, such as averaging or arithmetic, before doing FFT. For example: if a stable trigger were available you could perform time-domain averaging to reduce random noise in the signal.

TIP: To increase the FFT frequency range — the Nyquist frequency — raise the effective sampling frequency by increasing the maximum number of points or using a faster time base.

To increase the FFT frequency resolution, increase the length of the time-domain waveform record by using a slower timebase.

USE CURSORS WITH FFT

Move the absolute time cursor into the frequency domain to read the amplitude and frequency of a data point. Do this by moving it beyond the right-hand edge of a time-domain waveform. Then move the relative time cursors into the frequency domain to simultaneously indicate the frequency difference and the amplitude difference between two points on each frequency-domain trace. Use the absolute voltage cursor to read the

absolute value of a point in a spectrum in the appropriate units. And adjust the relative Voltage cursors to indicate the difference between two levels on each trace.

NOTE: *The following FFT-related error messages may appear at the top of the screen:*

“Incompatible input record type” – FFT Average done on a function not defined as FFT.

“Horizontal units don’t match” – FFT of a frequency-domain waveform is not available.

“FFT source data zero filled” – If there are invalid data points in the source waveform (at the beginning or at the end of the record), these are replaced by zeros before FFT processing.

“FFT source data over/underflow” – The source waveform data has been clipped in amplitude, either in the acquisition — gain too high or inappropriate offset — or in previous processing. The resulting FFT contains harmonic components that would not be present in the unclipped waveform. The settings that define the acquisition or processing should be changed indirectly by means of another function or expansion. One of the definitions should be changed to eliminate the over/underflow condition.

“Circular computation” – A function definition is circular (i.e., the function is its own source).



PART TWO: LOOKING DEEPER

TO SET UP FFT SPAN AND RESOLUTION



To set up an FFT correctly, start with the frequency resolution, or Δf . This is the spacing of samples in the frequency domain display. Set the Δf by inputting the time duration of the time domain signal to the FFT.

If an acquisition channel (Channel 1, 2, or 3 or 4) is the source, then the waveform duration is the capture time: the TIME/DIV setting multiplied by 10. If the source waveform is a zoom trace, the frequency resolution is the reciprocal of the displayed waveform's duration. The relationship between capture time and frequency resolution is illustrated below (Fig. 1).

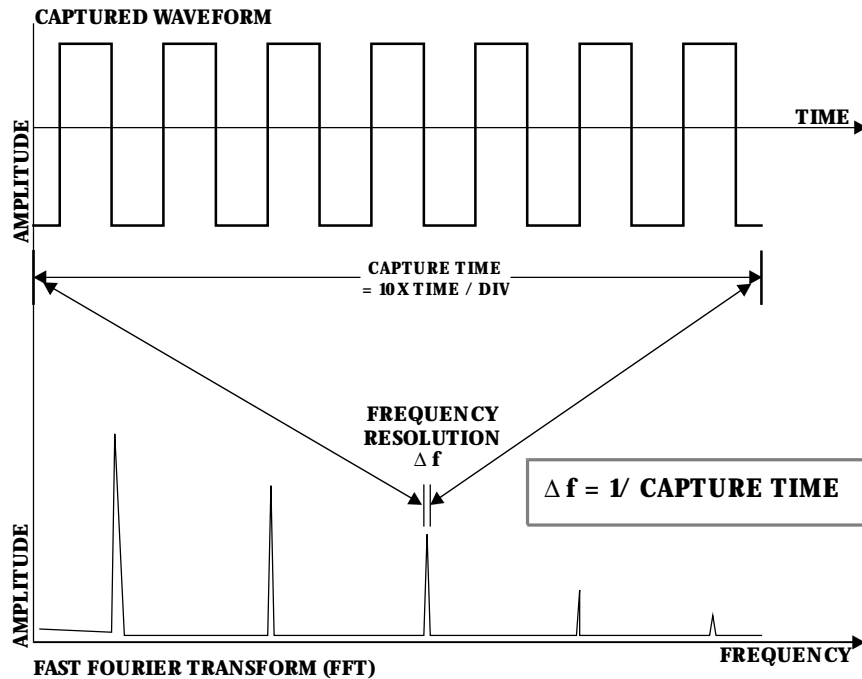

Figure 1. Capture time determines the frequency resolution Δ .

The frequency span of the FFT is called the Nyquist frequency, and is related to the sampling frequency of the time domain waveform. If the math memory size is identical to the number of samples in the acquired waveform, then the span will be half the sampling frequency. But if this “max points for math” number is less than the number of points, the waveform and the FFT span will be decimated. The relationship between the FFT span and the sampling rate ($1/\Delta T$) is illustrated on the next page (Fig. 2).

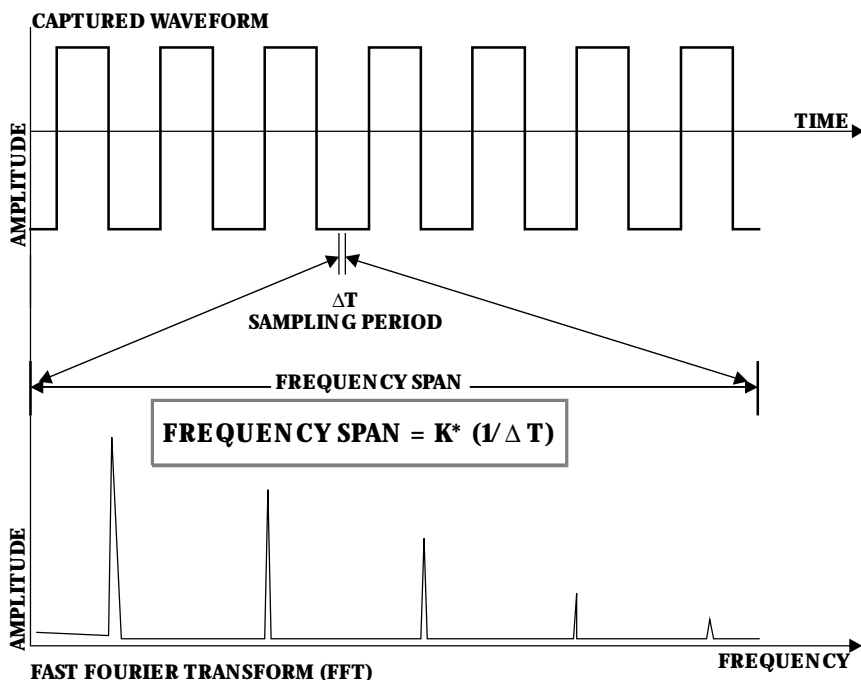

Figure 2. The span of the FFT is related to the sampling rate ($1/\Delta T$).

The Waverunner automatically adjusts the span, and the FFT transform size, to account for the “max points for math” you enter, as well as the display scaling. The scope may also adjust the length of the displayed trace. You can read the span in the displayed trace label for the trace with FFT, with the horizontal calibration in Hz/div. It is also displayed as the Nyquist frequency in the information field that appears at the bottom of the screen when you set up for FFT.

SET FFT SPAN

1. To obtain the FFT span you want, first make sure that your sampling rate is more than twice the span desired. Control the sampling rate, then set the acquisition memory length. You could further adjust the sampling rate by limiting the number of points. For example, to analyze a continuous periodic waveform, you may wish to have a span of 10 MHz and frequency resolution of 10 kHz. That frequency resolution would require a capture time of 100 μ s. You would therefore set the time per division to 10 μ s to obtain the necessary Δf of 10 kHz. You would need an effective sampling rate of greater than 20 MS/s in order to obtain the required 10 MHz span. On a Waverunner scope with a sampling rate of 500 MS/s and a 50 000-sample default memory length, you would use a 10 μ s time/div setting to first give a 250 MHz span.

PART TWO: LOOKING DEEPER

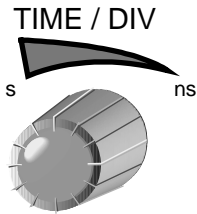
2. Turn  and set time per division to 10 μ s.

TIP: Of the two methods proposed in Step 3 below, the second is preferable because it maintains a high input sampling rate and reduces the risk of aliasing the captured data.

Then, to obtain the 10 MHz span, reduce the sampling rate in either of two ways:

3. Press  and decrease the number of samples by setting the “record up to” menu to 2500 in a sampling rate of 25 MS/s.

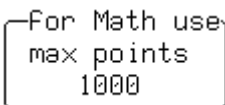
Alternatively, use  to limit the number of points to 2500. Choosing this method would leave the sampling rate at 500 MS/s but decimate the waveform data before the FFT to reduce the effective sampling rate to 25 MS/s. This would in turn give a span of 12.5 MHz, the closest achievable span to > 10 MHz.

A sampling rate of 25 MS/s would result in a full-scale range of 12.5 MHz (1.25 MHz per division). To maintain a display scale factor of 1, 2, or 5, your Waverunner scope would decimate the acquired waveform and calculate the FFT using a 2000-point transform. This would result in a scale factor of 2 MHz/Div. The display would be truncated at 6.25 divisions to retain the original 12.5 MHz span.

FFT WINDOW FILTER PARAMETERS				
Window Type	Highest Side Lobe (dB)	Scallop Loss (dB)	ENBW (bins)	Coherent Gain (dB)
Rectangular	-13	3.92	1.0	0.0
von Hann	-32	1.42	1.5	-6.02
Hamming	-43	1.78	1.37	-5.35
Flat Top	-44	0.01	2.96	-11.05
Blackman-Harris	-67	1.13	1.71	-7.53

Use an Advanced Math Function

These functions allow you to automatically carry out complex computations on your signal. See Chapter 5, “Use Math Tools,” for the full range of standard and optional math functions. To choose and use a function:

1. Follow the steps for setting up to do math on Trace A, B, C, or D.
2. Then use these menus to choose and use an advanced math function.

NOTE: *Waverunner computes square root on the absolute value of the waveform. For logarithmic and exponential functions, it uses the input signal's numerical value without units.*

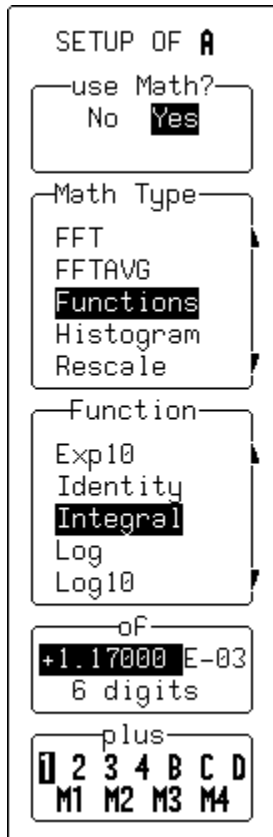

To select to do math.



To select **Functions**.



To select **Integral**, for example.



To set the signal offset to compensate for any DC offset in the signal.

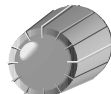

To select the source waveform.

NOTE: *When you use Integral, your source signal can be offset by an additive constant in the range -10^6 to $+10^6$ times the vertical unit of the signal.*

Resample to Deskew

Deskew whenever you need to compensate for different lengths of cables, probes or anything else that causes timing mismatches between signals. Resample a signal on one channel and adjust it in time relative to a signal on another.

1. Display the signals on two different channels.
2. Press  to make a zoom of the channel whose signal you wish to adjust in time.

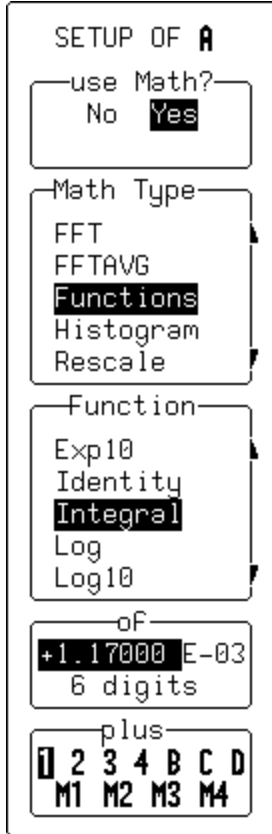

3. Use these menus to deskew the signal.



To select to do math.



To select **Resample**.

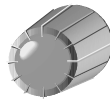

To adjust with the knob, in the range ± 2000 ns, the signal on Trace A, and compensate for the timing differences between it and the other signal.

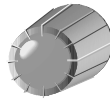

To select the channel whose signal you wish to adjust.

Plot Trends

Plot a line graph of a parameter's evolution over time using the optional Trend feature (EMM Option). And eliminate the need to make and record a large number of individual measurements. When you set up the trend plot, Waverunner will generate it automatically as the scope takes data, making the measurements and plotting the values for you. The graph's vertical axis will be the value of the parameter, and its horizontal axis the order in which the values were captured. In this way you can graphically display up to 20 000 individual parameter measurements on each trace, using any of more than 100 available parameters as the trend source. You can also cross-plot two trends on an X-Y display and see the functional relationships between the two parameters.

1. Set up a custom parameter for the trend. See the next chapter, "Analyze with Parameters."
2. Follow the steps for setting up to do math on Trace A, B, C, or D.

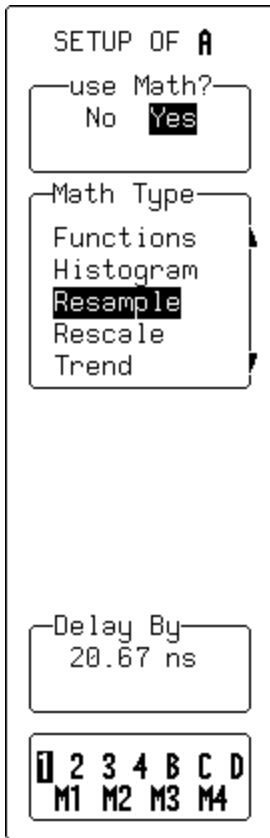

3. Use these and the menus on the next page to create your trend graph.



To select for math.



To select **Trend**.



To select parameters and further configure the trend (see next page).



To position the trend automatically once calculated. Also centers and scales the trend without affecting zoom or position settings.

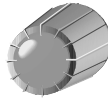

To select the parameter line to be used in the trend.

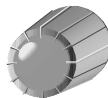

To select (using button or knob) the number of values in the trend. A maximum of 20 000 values can be chosen for any one trend. When this maximum is exceeded, the parameter results scroll off the trend.

SETUP OF A

use Math?
No Yes

Math Type
Per.Hist
Per.Trace
Resample
Rescale
Trend

MORE
TREND SETUP

FIND CENTER
AND HEIGHT

Trend of
custom line 1
ampl(1)

using up to
1000
(values)

TIP: See the LeCroy Application Briefs (LABs) covering trend plots for help in a range of applications. Ask your LeCroy customer service center, or find these and other useful LABs at LeCroy's web site: <http://www.lecroy.com/Labs/default.asp>



To select **All**: every parameter calculation on each waveform will be placed in the trend. Or **Average**: to trend only the average of all the given values calculated, and obtain one point in the trend, per capture.

To access the CHANGE PARAM menus and select or configure a parameter. See the next chapter, "Parameter Analysis."

To position the trend automatically once calculated. Also centers and scales the trend without affecting zoom or position settings.



To set the trend's center value.

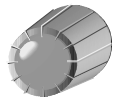

To select the value of each vertical display division. The height per division multiplied by number of vertical display divisions (eight) determines the range of parameter values centered on the number in the "Center" menu, used to create the trend.

RETURN



To return to the previous menu group.

READ TRENDS

Once the trend plot is displayed, trace labels like the ones below — for Trace A in these examples — appear in their customary place on-screen, identifying the trace and the math performed, and giving horizontal and vertical information.

```

A: Tmp1(1)
 20 #
 200  $\mu$ V
 49.731mV
inside 200
    
```

Number of events per horizontal division
Units per vertical division, in units of the parameter being measured
Vertical value at point in trend at cursor location when using cursors
Number of events in trend that are within unzoomed horizontal display range

```

A: Tmp1(1)
 20 #
 200  $\mu$ V
 ↓1%/↑0%
inside 193
    
```

Percentage of values lying beyond the unzoomed vertical range when not in cursor measurement mode

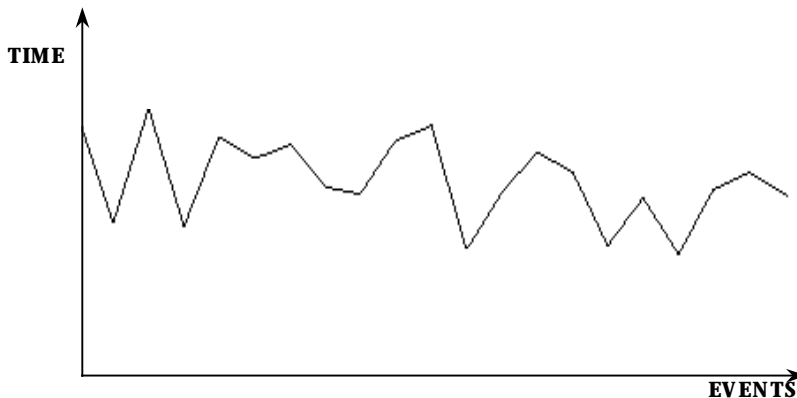

Figure 3. A trend's horizontal axis is in units of events, with the earlier events in the leftmost part of the waveform and later ones on the right. The vertical axis is in the same units as the trended parameter.

TO CALCULATE TRENDS



Once you have configured the trend, parameter values will be calculated and trended on each subsequent capture.

The trend values will be calculated immediately following the capture. The resulting trend is a waveform of data points that can be used in the same way as any other waveform. Parameters can be calculated on it, and it can be zoomed; it can serve as the x or y trace in an XY plot, or be used in cursor measurements.

The sequence for acquiring trend data is:

- 1. Trigger*
- 2. Waveform capture*
- 3. Parameter calculation(s)*
- 4. Trend update*
- 5. Trigger re-arm*

If you set the timebase in a mode other than sequence, a single acquisition occurs prior to parameter calculations. However, in sequence mode an acquisition for each segment occurs prior to parameter calculations. If the source of the trend data is a memory, when you save new data to memory, this acts as a trigger and acquisition. Because updating the screen can take significant processing time, the process occurs only once a second, minimizing trigger dead time (and under remote control the display can be turned off to maximize measurement speed).

The Waverunner oscilloscope maintains a circular parameter buffer of the last 20 000 measurements made, including values that fall outside the set trend range. If the maximum number of events to be used in a trend is a number 'N' less than 20 000, the trend will be continuously updated with the last 'N' events as new acquisitions occur. If the maximum number is greater than 20 000, the trend will be updated until the number of events is equal to 'N'. Then, if the number of bins or the trend range is modified, the scope will use the parameter buffer values to redraw the trend with either the last 'N' or 20 000 values acquired — whichever is the lesser. This parameter allows trends to be redisplayed using an acquired set of values and settings that produce a distribution shape with the most useful information. Once it is in buffer, you can display the trend in different scaling ranges without reacquiring data.

*In many cases the optimal range is not readily apparent. For this reason the scope has a powerful range finding function: **FIND CENTER AND HEIGHT** (see page 140). If necessary, it will examine the values in the parameter buffer to calculate an optimal range, and use it to redisplay the trend. Waverunner will also give a running count of the number of parameter values that fall within, below, and above the range. If any fall below or above the range, the range finder can then recalculate to include these parameter values, as long as they are still within the buffer.*

The number of events captured per waveform acquisition or display sweep depends on the parameter type. Acquisitions are initiated by the occurrence of a trigger event. Sweeps are equivalent to the

waveform captured and displayed on an input channel. For non-segmented waveforms a capture is the same as a sweep, whereas for segmented waveforms an acquisition occurs for each segment and a sweep is equivalent to captures for all segments. Only the section of a waveform between the parameter cursors is used in the calculation of parameter values and corresponding trend events. The table provides a summary of the number of trend events captured per acquisition or sweep for each standard parameter and for a waveform section between the parameter cursors.



CHAPTER ELEVEN: *Analyze with Parameters*

Part One introduced Waverunner Measure Tools. Now use their advanced aspects to troubleshoot and analyze your waveform.

In this chapter, see how

To customize parameters

To perform Pass/Fail tests

Parameters work

Each parameter plays a special role in measurement

Use Custom Parameters

MEASURE
TOOLS

1. Press  to display the MEASURE menus. See Part One, Chapter 4, "Choose a Measure Tool."
2. Press the button to select **Parameters**, and the button for **Custom** in the mode menu. Use statistics if desired, and set the starting and end point for the parameter measurements using the from and to menus.

3. Then press the button to select  and access the CHANGE PARAM menus.

CHANGE PARAM

On line

1 2 3 4 5

Category

All

DISK-Std

DISK-Local

DISK-PRML

JTA

DELETE ALL PARAMETERS

measure

--

acsn

amp

area

avg

of

1 2 3 4

A B C D

4. Use them to change your parameters.



To select a line, and the parameter allocated to it, for modification. Five lines with five unique parameters can be displayed and modified.



To select the parameter category.



To delete all five assigned parameters from the lines.



To place a new parameter for measurement on the line selected above. When "--" is selected, that line is not used.

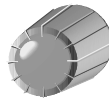
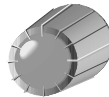

To select the channel or trace on which the parameter will be measured.

CUSTOMIZE A PARAMETER

You can customize certain parameters to meet special needs:

1. Take, for example, Δ time at level, a parameter that computes the transition between different levels of a waveform, or between different sources.
2. Press the button to select the **All** category, and the button to choose **$\Delta t@lv$** from the measure menu.

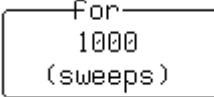
3. Turn the upper knob to set the number of sweeps: 

4. Press the button to select channel or memory  Turn the knob for **from** and **to**.

5. Then press the button to select 

From the SETUP of $\Delta t@lv$ menus then displayed:

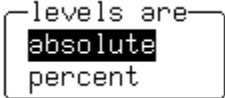
6. Press the button to set levels in either absolute or peak-to-peak percent signal values: 
7. Press the button to set the hysteresis in divisions. This is a voltage band that extends equidistantly above and below the selected level. In order for the signal to be considered valid, and not as noise, the signal must exceed, or cross, the upper or lower limits of this band by half the hysteresis division setting.
8. Turn the knob to set the voltage or amplitude percent level in the “from” menu.

This determines where on the waveform Waverunner will start the timing measurement.

9. Press the button to make the measurement on a positive (rising) or negative (falling) edge. Or, with **First**, to make it on either edge.
10. Finally, turn the knob to set the voltage or amplitude percentage in the “to” menu.

This determines the level on the waveform at which the timing is to end.

11. Press the button to end the measurement on a positive (rising) or negative (falling) edge. Or, with **First**, to end it on either edge.

Test for Pass and Fail

You can also use parameters to carry out Pass/Fail tests. These require a combination of measurements within chosen limits. The Waverunner invokes an action when the test passes or fails — depending on what you specify. You can also test signals against a tolerance mask. As with custom parameters, you can use as many as five parameters at the same time. Whether the tests pass or fail, any or all of the following actions can be invoked:

- Stop capturing further signals
- Dump the screen image to a hardcopy unit
- Store selected traces to internal memory, to an optional device in the PC Card slot, or to floppy disk
- Sound the buzzer
- Emit a pulse through the rear BNC connector

The display will show you the results on the current waveforms, the number of passing events, the total number of sweeps treated, and the actions for you to take.

SET UP A PASS/ FAIL TEST

1. Set up for parameters in the MEASURE menu as shown in Chapter 4 and on the preceding pages.
2. Press the button to select **Pass** or **Fail** in the mode menu. Use statistics if desired, and set the starting and end points for the parameter measurements using the “from” and “to” menus.

3. Then press the button to select

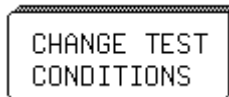

From the CHANGE TEST menu displayed:

4. Press the button to set one or more of the five parameter lines.
5. Press the button to select **Param** from the Test on menu for testing using that parameter; “---” for no test.
6. And press the button to select **Param** from the choose menu.
7. Set the other menus displayed as desired, according to the description on page 145.
8. Then if you wish to change the Pass/Fail test limit on the parameter, press the button to select **Limit** from the choose menu.

9. Press the button to select the adequate relation — smaller or greater than — from:

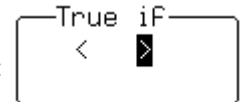

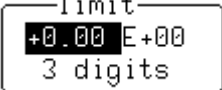
10. Then press the button to select from  one of three possible modifications to the limit.

These are the limit's mantissa, exponent, and the number of digits to be represented in its mantissa.

11. Turn the knob to set the value for these.
12. Finally, press the bottom button to set the limit to the latest measured value — a starting value for the final adjustment.

PASS/ FAIL TEST ON A MASK

1. Follow the CHANGE TEST Steps 1 to 5 described above.
2. Press the button to select **Mask** from the “Test on” menu for testing using that parameter; “---” for no test.

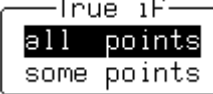
3. Press the button to select the mask test condition from 

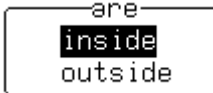
4. Press the button to select the mask test condition from 

5. Press the button to select the channel or trace for testing from the of menu, and the button for the trace on which the mask is to be placed from the mask menu.

NOTE: Pass/Fail testing against a mask is affected by horizontal and vertical zooming of the mask trace. The test will be made inside the area bordered by the parameter cursors. Timebases of the mask and the trace under test should be identical. For visual mask testing, use a single grid when performing a mask test on a single trace; dual-grid display for testing on two traces.

MAKE A WAVEFORM MASK

1. Press the button to select  from the mask CHANGE TEST menus described above.

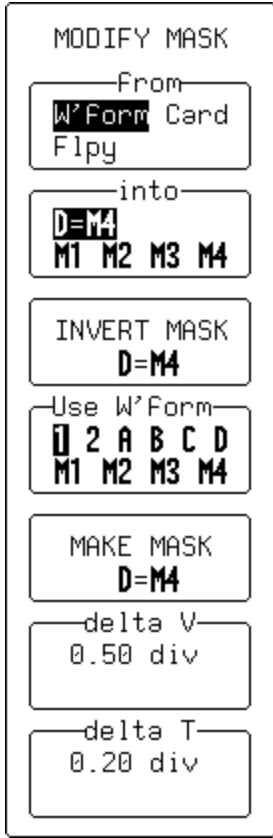

MODIFY MASK

From
W'Form Card
Flpy

into
D=M4
M1 M2 M3 M4









INVERT MASK
D=M4

Use W'Form
2 A B C D
M1 M2 M3 M4

MAKE MASK
D=M4

delta V
0.50 div

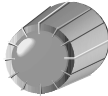
delta T
0.20 div

2. Use these menus to generate a mask from your waveform.
 -  Select **W'form** to generate the mask from your displayed waveform; **Card** to display menus for recalling a mask stored to an optional device in the PC Card slot; **Floppy** to recall a stored mask from floppy disk.
 -  To select **D=M4** if the mask is to be automatically displayed on the screen. Otherwise select **M1**, **M2**, **M3**, or **M4**. Use the "RECALL W'FORM" menus to recall and display a memory on a trace.
 -  To generate an inverted mask.
 -  To select the waveform to be used as the reference. Waverunner will generate the mask around this.
 -  To make the mask.
 -   To select the tolerance in amplitude with the knob.
 -   To select the tolerance in time with the knob.

CHANGE A TEST ACTION

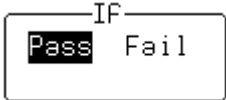
1. From the CHANGE TEST menus press the button to select **Action** in the On line.
2. Press the button to determine if the action will be taken on Pass or Fail: 
3. Press the button to select the action in the "Then" menu. And press the button to activate (**Yes**) or disable (**No**) this action in the final menu, now named for the action chosen. This yes or no is in turn shown in "Then."

PART TWO: LOOKING DEEPER

HOW WAVERUNNER PARAMETERS WORK



Proper determination of the top and base reference lines is fundamental for ensuring correct parameter calculations. The analysis begins with Waverunner computing a histogram of the waveform data over the time interval spanned by the left and right time cursors.

For example, the histogram of a waveform transitioning in two states will contain two peaks (Fig. 1). The analysis will attempt to identify the two clusters that contain the largest data density. Then the most probable state (centroids) associated with these two clusters will be computed to determine the top and base reference levels: the top line corresponds to the top and the base line to the bottom centroid. Once top and base are estimated, Waverunner easily calculates the rise and fall times. The oscilloscope automatically determines the 90% and 10% threshold levels, using the amplitude (ampl) parameter. (Histograms are part of the WaveAnalyzer option.)

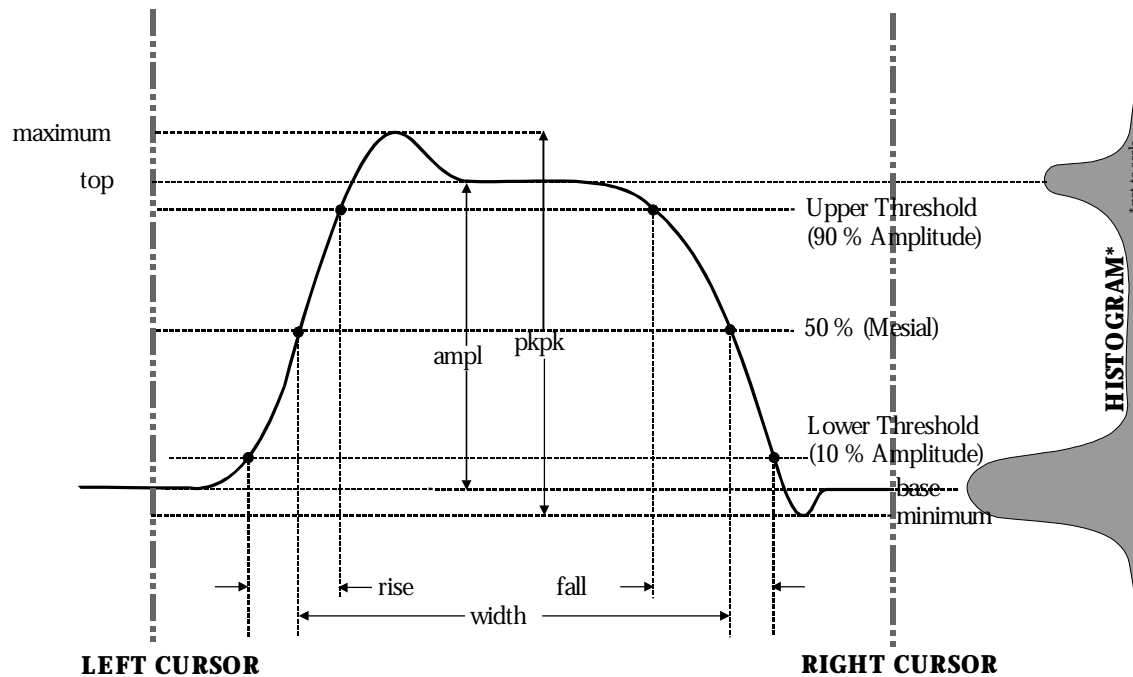

Figure 1.

Threshold levels for rise or fall time can also be selected using absolute or relative settings ($r@$ level, $f@$ level). If absolute settings are chosen, the rise or fall time is measured as the time interval separating the two crossing points on a rising or falling edge. But when relative settings are chosen, the vertical interval spanned between the base and top lines is subdivided into a percentile scale (base = 0%, top = 100%) to determine the vertical position of the crossing points.

Rising Edge Duration	$\frac{1}{Mr} \sum_{i=1}^{Mr} (Tr_i^{90} - Tr_i^{10})$
Falling Edge Duration	$\frac{1}{Mf} \sum_{i=1}^{Mf} (Tf_i^{10} - Tf_i^{90})$
<p>Where Mr is the number of rising edges found, Mf the number of falling edges found, Tr_i^x the time when rising edge i crosses the $x\%$ level, and Tf_i^x the time when falling edge i crosses the $x\%$ level.</p>	

The time interval separating the points on the rising or falling edges is then estimated to yield the rise or fall time. These results are averaged over the number of transition edges that occur within the observation window.



Time parameter measurements such as width, period and delay are carried out with respect to the mesial reference level (Fig. 2), located halfway (50%) between the top and base reference lines. Time parameter estimation depends on the number of cycles included within the observation window. If the number of cycles is not an integer, parameter measurements such as rms or mean will be biased.

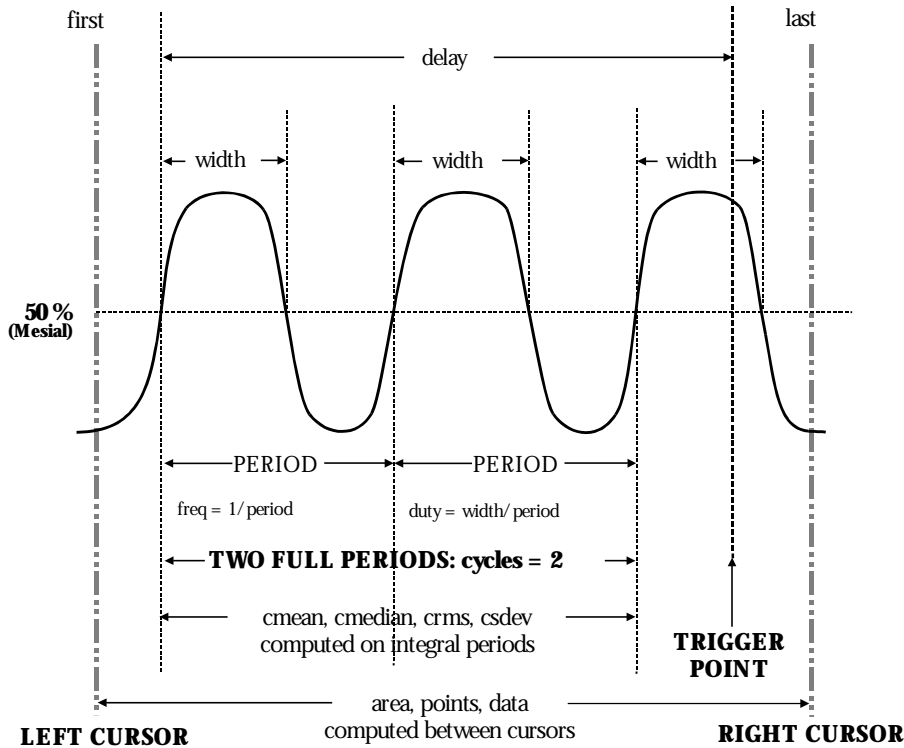

Figure 2.

PART TWO: LOOKING DEEPER

To avoid these bias effects, the instrument uses cyclic parameters, including c_{rms} and c_{mean} , that restrict the calculation to an integer number of cycles. The Waverunner enables accurate differential time measurements between two traces — for example, propagation, setup and hold delays (Fig. 3). Parameters such as $\Delta c2d\pm$ require the transition polarity of the clock and data signals to be specified.

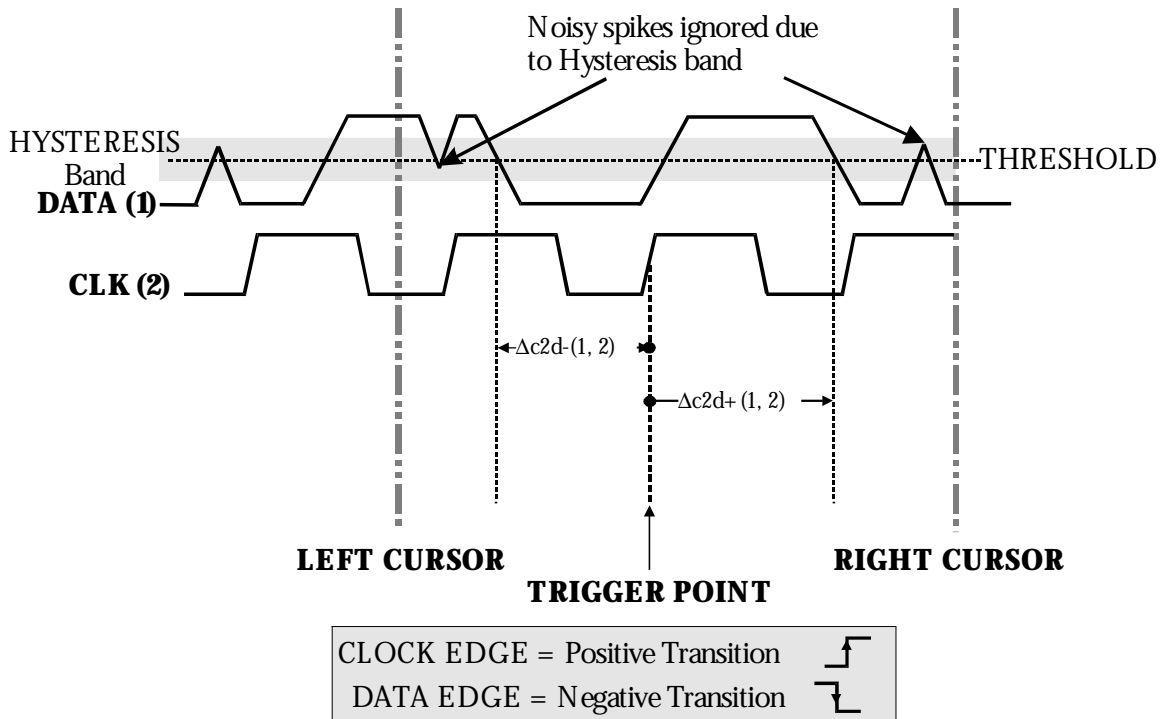



Figure 3.



Moreover, a hysteresis range may be specified to ignore any spurious transition that does not exceed the boundaries of the hysteresis interval. In Figure 3, $\Delta c2d-(1, 2)$ measures the time interval separating the rising edge of the clock (trigger) from the first negative transition of the data signal. Similarly, $\Delta c2d+(1, 2)$ measures the time interval between the trigger and the next transition of the data signal.



Choose a Parameter

The following table lists, describes and defines Waverunner parameters. Those indicated by the  symbol are in the Extended Math and WaveAnalyzer options (see Chapter 5, "Use a Math Tool"). All the other parameters listed here are standard on Waverunner.



PARAMETER	DESCRIPTION	DEFINITION	NOTES
ampl	Amplitude: Measures difference between upper and lower levels in two-level signals. Differs from <i>pkpk</i> in that noise, overshoot, undershoot, and ringing do NOT affect measurement.	<i>top</i> – <i>base</i> (See Fig. 1)	<i>On signals NOT having two major levels (such as triangle or saw-tooth waves), returns same value as pkpk.</i>
area	Integral of data: Computes area of waveform between cursors relative to zero level. Values greater than zero contribute positively to the area; values less than zero negatively.	Sum from <i>first</i> to <i>last</i> of data multiplied by horizontal time between points (See Fig. 2)	
base	Lower of two most probable states (higher is <i>top</i>). Measures lower level in two-level signals. Differs from <i>min</i> in that noise, overshoot, undershoot, and ringing do NOT affect measurement.	Value of most probable lower state (See Fig. 1)	<i>On signals NOT having two major levels (triangle or saw-tooth waves, for example), returns same value as min.</i>
cycles	Determines number of cycles of a periodic waveform lying between cursors. First cycle begins at first transition after the left cursor. Transition may be positive- or negative-going.	Number of cycles of periodic waveform (See Fig. 2)	
cmean	Cyclic mean: Computes the average of waveform data. Contrary to <i>mean</i> , computes average over an integral number of cycles, eliminating bias caused by fractional intervals.	Average of data values of an integral number of periods	
cmedian 	Cyclic median: Computes average of base and top values over an integral number of cycles, contrary to <i>median</i> , eliminating bias caused by fractional intervals.	Data value for which 50 % of values are above and 50 % below	

PART TWO: LOOKING DEEPER

PARAMETER	DESCRIPTION	DEFINITION	NOTES
cms	Cyclic root mean square: Computes square root of sum of squares of data values divided by number of points. Contrary to <i>rms</i> , calculation is performed over an integral number of cycles, eliminating bias caused by fractional intervals.	$\sqrt{\frac{1}{N} \sum_{i=1}^N (v_i)^2}$	Where: v_i denotes measured sample values, and N = number of data points within the periods found up to maximum of 100 periods.
csdev 	Cyclic standard deviation: Standard deviation of data values from mean value over integral number of periods. Contrary to <i>sdev</i> , calculation is performed over an integral number of cycles, eliminating bias caused by fractional intervals.	$\sqrt{\frac{1}{N} \sum_{i=1}^N (v_i - \text{mean})^2}$	Where: v_i denotes measured sample values, and N = number of data points within the periods found up to maximum of 100 periods.
delay	Time from trigger to transition: Measures time between trigger and first 50% crossing after left cursor. Can measure propagation delay between two signals by triggering on one and determining delay of other.	Time between trigger and first 50% crossing after left cursor (See Fig. 2)	
Δdly	Δdelay: Computes time between 50% level of two sources.	Time between midpoint transition of two sources	
Δt@lv 	Δt at level: Computes transition between selected levels or sources.	Time between transition levels of two sources, or from trigger to transition level of a single source	Reference levels and edge-transition polarity can be selected. Hysteresis argument used to discriminate levels from noise in data.
Δc2d± 	Δclock to data ±: Computes difference in time from clock threshold crossing to either the next (Δc2d+) or previous (Δc2d-) data threshold crossing.	Time from clock threshold crossing to next or previous edge (See Fig. 3)	Threshold levels of clock and data signals, and edge transition polarity can be selected. Hysteresis argument used to differentiate peaks from noise in data, with good hysteresis value between half expected peak-to-peak value of signal and twice expected peak-to-peak value of noise.

PARAMETER	DESCRIPTION	DEFINITION	NOTES																				
dur 	For single sweep waveforms, <i>dur</i> is 0; for sequence waveforms: time from first to last segment's trigger; for single segments of sequence waveforms: time from previous segment's to current segment's trigger; for waveforms produced by a history function: time from first to last accumulated waveform's trigger.	Time from first to last acquisition: for average, histogram or sequence waveforms																					
duty	Duty cycle: Width as percentage of period.	$width/period$ (See Fig. 2)																					
f80-20%	Fall 80-20%: Duration of pulse waveform's falling transition from 80% to 20%, averaged for all falling transitions between the cursors.	Average duration of falling 80-20% transition	<i>On signals NOT having two major levels (triangle or saw-tooth waves, for example), top and base can default to maximum and minimum, giving, however, less predictable results.</i>																				
f@ level 	Fall at level: Duration of pulse waveform's falling edges between transition levels.	Duration of falling edge between transition levels	<i>On signals NOT having two major levels (triangle or saw-tooth waves, for example), top and base can default to maximum and minimum, giving, however, less predictable results.</i>																				
fall <table border="1" data-bbox="418 1050 841 1197"> <thead> <tr> <th colspan="5">ARGUMENTS</th> </tr> <tr> <th>Threshold</th> <th>Remote</th> <th>Lower Limit</th> <th>Upper Limit</th> <th>Default</th> </tr> </thead> <tbody> <tr> <td>Lower</td> <td>Low</td> <td>1%</td> <td>45%</td> <td>10%</td> </tr> <tr> <td>Upper</td> <td>High</td> <td>55%</td> <td>99%</td> <td>90%</td> </tr> </tbody> </table>	ARGUMENTS					Threshold	Remote	Lower Limit	Upper Limit	Default	Lower	Low	1%	45%	10%	Upper	High	55%	99%	90%	Fall time: Measures time between two specified values on falling edges of a waveform. Fall times for each edge are averaged to produce final result.	Time at lower threshold minus Time at upper threshold averaged over each falling edge (See Fig. 1)	<i>On signals NOT having two major levels (triangle or saw-tooth waves, for example), top and base can default to maximum and minimum, giving, however, less predictable results.</i>
ARGUMENTS																							
Threshold	Remote	Lower Limit	Upper Limit	Default																			
Lower	Low	1%	45%	10%																			
Upper	High	55%	99%	90%																			
	Threshold arguments specify two vertical values on each edge used to compute fall time. Formulas for upper and lower values: $\text{lower value} = \text{lower threshold} \times \frac{amp}{100} + base$ $\text{upper value} = \text{upper threshold} \times \frac{amp}{100} + base$																						



PART TWO: LOOKING DEEPER

PARAMETER	DESCRIPTION	DEFINITION	NOTES
first 	Indicates value of horizontal axis at left cursor.	Horizontal axis value at left cursor (See Fig. 2)	<i>Indicates location of left cursor. Cursors are interchangeable: for example, the left cursor may be moved to the right of the right cursor and first will give the location of the cursor formerly on the right, now on left.</i>
freq	Frequency: Period of cyclic signal measured as time between every other pair of 50% crossings. Starting with first transition after left cursor, the period is measured for each transition pair. Values then averaged and reciprocal used to give frequency.	$1/\text{period}$ (See Fig. 2)	
last 	Time from trigger to last (rightmost) cursor.	Time from trigger to last cursor (See Fig. 2)	<i>Indicates location of right cursor. Cursors are interchangeable: for example, the right cursor may be moved to the left of the left cursor and first will give the location of the cursor formerly on the left, now on right.</i>
maximum	Measures highest point in waveform. Unlike <i>top</i> , does NOT assume waveform has two levels.	Highest value in waveform between cursors (See Fig. 1)	<i>Gives similar result when applied to time domain waveform or histogram of data of same waveform. But with histograms, result may include contributions from more than one acquisition. Computes horizontal axis location of rightmost non-zero bin of histogram — not to be confused with maxp.</i>
mean	Average of <i>data</i> for time domain waveform. Computed as centroid of distribution for a histogram.	Average of <i>data</i> (See Fig. 2)	<i>Gives similar result when applied to time domain waveform or histogram of data of same waveform. But with histograms, result may include contributions from more than one acquisition.</i>
median 	The average of base and top values.	Average of <i>base</i> and <i>top</i> (See Fig. 2)	

PARAMETER	DESCRIPTION	DEFINITION	NOTES
minimum	Measures the lowest point in a waveform. Unlike <i>base</i> , does NOT assume waveform has two levels.	Lowest value in waveform between cursors (See Fig. 1)	<i>Gives similar result when applied to time domain waveform or histogram of data of same waveform. But with histograms, result may include contributions from more than one acquisition.</i>
over-	Overshoot negative: Amount of overshoot following a falling edge, as percentage of amplitude.	$\frac{b_{base} - \text{minimum}}{ampl} \times 100$ (See Fig. 2)	<i>Waveform must contain at least one falling edge. On signals NOT having two major levels (triangle or saw-tooth waves, for example), may NOT give predictable results.</i>
over+	Overshoot positive: Amount of overshoot following a rising edge specified as percentage of amplitude.	$\frac{b_{maximum} - \text{top}}{ampl} \times 100$ (See Fig. 1)	<i>Waveform must contain at least one rising edge. On signals NOT having two major levels (triangle or saw-tooth waves, for example), may NOT give predictable results.</i>
period	Period of a cyclic signal measured as time between every other pair of 50% crossings. Starting with first transition after left cursor, period is measured for each transition pair, with values averaged to give final result.	$\frac{1}{M_r} \sum_{i=1}^{M_r} (T_{r_i}^{50} - T_{f_i}^{50})$ (See Fig. 2)	<i>Where: M_r is the number of leading edges found, M_f the number of trailing edges found, $T_{r_i}^x$ the time when rising edge i crosses the $x\%$ level, and $T_{f_i}^x$ the time when falling edge i crosses the $x\%$ level.</i>
pkpk	Peak-to-peak: Difference between highest and lowest points in waveform. Unlike <i>ampl</i> , does not assume the waveform has two levels.	<i>maximum minus minimum</i> (See Fig. 1)	<i>Gives a similar result when applied to time domain waveform or histogram of data of the same waveform. But with histograms, result may include contributions from more than one acquisition.</i>
phase	Phase difference between signal analyzed and signal used as reference.	Phase difference between signal and reference	
points 	Number of points in the waveform between the cursors.	Number of points between cursors (See Fig. 2)	

PART TWO: LOOKING DEEPER

PARAMETER	DESCRIPTION	DEFINITION	NOTES																				
r20-80%	Rise 20% to 80%: Duration of pulse waveform's rising transition from 20% to 80%, averaged for all rising transitions between the cursors.	Average duration of rising 20-80% transition	<i>On signals NOT having two major levels (triangle or saw-tooth waves, for example), top and base can default to maximum and minimum, giving, however, less predictable results.</i>																				
r@ level 	Rise at level: Duration of pulse waveform's rising edges between transition levels.	Duration of rising edges between transition levels	<i>On signals NOT having two major levels (triangle or saw-tooth waves, for example), top and base can default to maximum and minimum, giving, however, less predictable results.</i>																				
rise	<p>Rise time: Measures time between two specified values on waveform's rising edge (10-90%). Rise times for each edge averaged to give final result.</p> <table border="1"> <thead> <tr> <th colspan="5">ARGUMENTS</th> </tr> <tr> <th>Threshold</th> <th>Remote</th> <th>Lower Limit</th> <th>Upper Limit</th> <th>Default</th> </tr> </thead> <tbody> <tr> <td>Lower</td> <td>Low</td> <td>1%</td> <td>45%</td> <td>10%</td> </tr> <tr> <td>Upper</td> <td>High</td> <td>55%</td> <td>99%</td> <td>90%</td> </tr> </tbody> </table> <p>Threshold arguments specify two vertical values on each edge used to compute rise time. Formulas for upper and lower values: lower value = lower threshold $\times \frac{amp}{100} + base$ upper value = upper threshold $\times \frac{amp}{100} + base$</p>	ARGUMENTS					Threshold	Remote	Lower Limit	Upper Limit	Default	Lower	Low	1%	45%	10%	Upper	High	55%	99%	90%	Time at upper threshold minus Time at lower threshold averaged over each rising edge (See Fig. 1)	<i>On signals NOT having two major levels (triangle or saw-tooth waves, for example), top and base can default to maximum and minimum, giving, however, less predictable results.</i>
ARGUMENTS																							
Threshold	Remote	Lower Limit	Upper Limit	Default																			
Lower	Low	1%	45%	10%																			
Upper	High	55%	99%	90%																			

PARAMETER	DESCRIPTION	DEFINITION	NOTES
rms	Root Mean Square of data between the cursors — about same as <i>sdev</i> for a zero-mean waveform.	$\sqrt{\frac{1}{N} \sum_{i=1}^N (v_i)^2}$ <p>(See Fig. 2)</p>	<i>Gives similar result when applied to time domain waveform or histogram of data of same waveform. But with histograms, result may include contributions from more than one acquisition. Where: v_i denotes measured sample values, and N = number of data points within the periods found up to maximum of 100 periods.</i>
sdev 	Standard deviation of the data between the cursors — about the same as <i>rms</i> for a zero-mean waveform.	$\sqrt{\frac{1}{N} \sum_{i=1}^N (v_i - \text{mean})^2}$ <p>(See Fig. 2)</p>	<i>Gives similar result when applied to time domain waveform or histogram of data of same waveform. But with histograms, result may include contributions from more than one acquisition. Where: v_i denotes measured sample values, and N = number of data points within the periods found up to maximum of 100 periods.</i>
t@ level 	Time at level: Time from trigger (t=0) to crossing at a specified level.	Time from trigger to crossing level	
top	Higher of two most probable states, the lower being <i>base</i> it is characteristic of rectangular waveforms and represents the higher most probable state determined from the statistical distribution of <i>data</i> point values in the waveform.	Value of most probable higher state (See Fig. 1)	<i>Gives similar result when applied to time domain waveform or histogram of data of same waveform. But with histograms, result may include contributions from more than one acquisition.</i>
width	Width of cyclic signal determined by examining 50% crossings in data input. If first transmission after left cursor is a rising edge, waveform is considered to consist of positive pulses and <i>width</i> the time between adjacent rising and falling edges. Conversely, if falling edge, pulses are considered negative and <i>width</i> the time between adjacent falling and rising edges. For both cases, widths of all waveform pulses averaged for final result.	Width of first positive or negative pulse averaged for all similar pulses (See Figs. 1, 2)	<i>Similar to fwhm, though, unlike width, that parameter applies only to histograms.</i>



CHAPTER TWELVE: *Use Waverunner with PC*

Operate your Waverunner scope using a personal computer:

In this chapter, see how

To transfer waveforms and data from scope to computer

To monitor Waverunner remote control operation

To save in ASCII

To use Waverunner with Spreadsheet, Mathcad and MATLAB

Transfer Data and Images to PC

Connect the Waverunner to a personal computer (PC) through the oscilloscope's rear GPIB or RS-232-C port. Then use LeCroy's handy ScopeExplorer software (see next page) to save data or images to the PC's hard disk. At the same time, the Waverunner's Remote Control Assistant can monitor and debug all your remote control communications (see page 163). But first, follow these steps to set up the scope for communication with the PC:

UTILITIES

1. Press  and then the button for

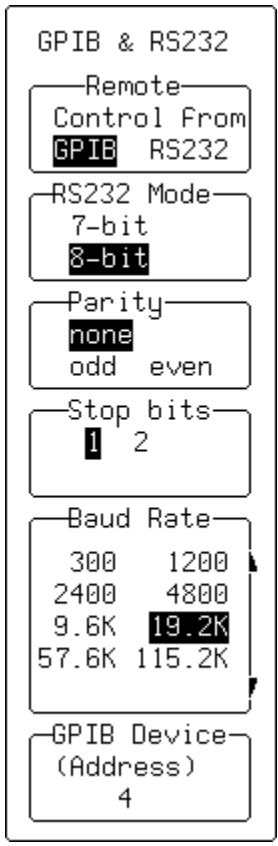

2. Use these menus to set up communication with the PC via GPIB or RS232.



To select **GPIB** or **RS232**. Select from the other menus according to this.



RS232: Press to select seven- or eight-bit word length for RS232. With **RS232** selected above, the GPIB interface is "talk-only." Any change is immediate.



RS232: Press to choose the appropriate RS232 parity.



RS232: Press to select the number of stop bits for RS232.



RS232: Turn the knob to set the Baud Rate for RS232.

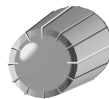

GPIB: Press or turn to select the GPIB address.

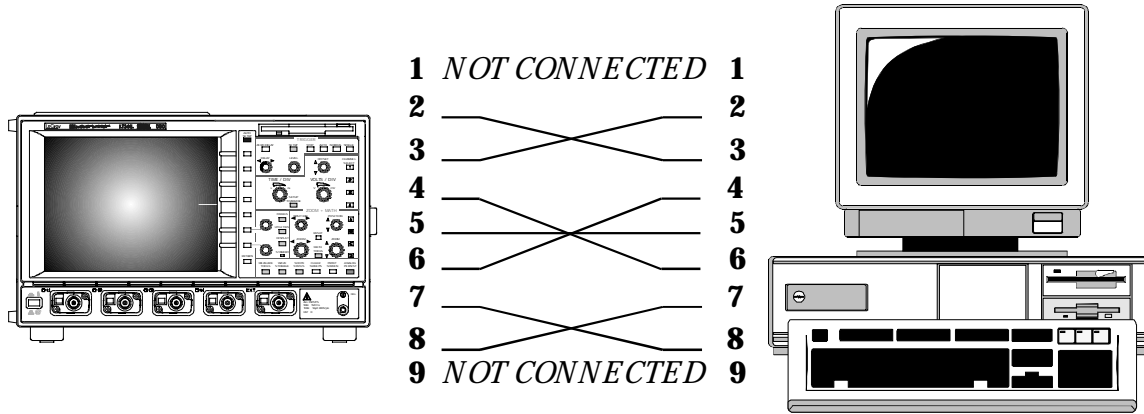

RS-232 nine-pin communication cabling for connecting Waverunner to PC.

EXPLORE YOUR SCOPE

ScopeExplorer is an easy-to-use and practical software tool for interfacing your Waverunner oscilloscope with computers running Windows. (See also “First Things” section.)

1. Connect the scope to a PC by using either the GPIB — you’ll need a PC with GPIB card installed — or PC-standard RS-232-C port on the scope’s rear panel.
2. Download ScopeExplorer free at <http://www.lecroy.com/scopeexplorer>. Or inquire at your LeCroy customer service center.
3. Having installed ScopeExplorer, open it as you would any Windows program. Use its on-line help to:

Use the teletype-like terminal to send standard remote control commands from computer to oscilloscope. And display the Waverunner response on the PC.

Control the scope using an interactive, virtual scope front panel!

Pipe sequences of commands from a file to the scope, then send the scope’s responses to another file. (See the *Remote Control Manual* for the commands.)

Transfer pixel-for-pixel copies of your Waverunner display to PC, view them, print them, or both from the computer. With a single press of a button or key, you can copy bitmap waveform images to the Windows Clipboard, ready to paste into any Windows application.

Capture Waverunner front panel setups and store them on the computer with a lengthy filename. You can then transfer them back into the scope to reproduce an identical setup.

Transfer, too, your waveforms to PC, and store them in either the compact LeCroy Binary format, or an ASCII version compatible with PC-based analysis products such as Microsoft’s Excel or Mathsoft’s MathCad (see page 164).

MONITOR YOUR REMOTE CONTROL OPERATIONS

Use the Waverunner Remote Control (RC) Assistant to automatically monitor remote commands received through the GPIB and RS232 ports. RC Assistant helps debug communications with the PC. When activated, it displays a log of the dialog between oscilloscope and PC. And whenever a communication error occurs, it gives the additional message "Remote Control: problem detected and logged."

UTILITIES

1. Press  to display the UTILITIES menus.

2. Press the button for  then the button for 

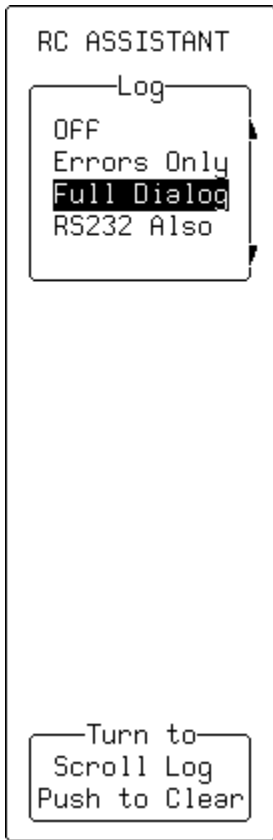

These menus will appear:



3. Press either of the top two menu buttons to select one of the following:

Off — the RC Assistant will NOT capture any remote commands.

Errors Only — displays only wrong or incomplete commands received via any remote control port (default after power-on).

Full Dialog — captures all remote commands received via any remote control port and displays up to 100 lines of dialog, after which lines are overwritten on a "first-in, first-out" basis.

RS232 Also — logs the full dialog and sends it to a recording device connected to the RS-232 port. When this is used, commands can only be received via the GPIB port.

(See also the commands `COMM_HELP` and `COMM_HELP_LOG` in the *Remote Control Manual*.)

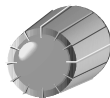

4. Turn this knob to enable log scrolling; press this button to clear the log entirely.

Save Waveforms in ASCII

When you save waveforms to a Waverunner internal memory (M1, M2, M3, or M4) you save them in LeCroy's special binary format. But you can also store your waveforms in ASCII format to a portable storage device such as floppy disk, PC memory card or hard disk card. You can then transfer the data to a PC for analysis with spreadsheet or math software.

In doing this you will create an output file requiring 10–20 times the disk space of the original LeCroy binary file. A one-megabyte record will typically take up 13–15 MB when stored in ASCII. And ASCII waveforms cannot be recalled back into the scope.

The Waverunner stores waveforms in any of three ASCII formats: Spreadsheet, MathCad, or MATLAB. The following table summarizes the format of the three basic layouts. You'll see how to set up to save in ASCII on the next pages, followed by examples of the use of each format.

FORMAT	HEADER	TIME VALUES	AMPLITUDE VALUES	SEQUENCE TIMES	MULTI-SEGMENT	DUAL ARRAY
	<i>Format includes some form of header before the data</i>	<i>Format stores time values with each amplitude value</i>	<i>Format stores amplitude values</i>	<i>Header contains sequence time information for each sequence segment</i>	<i>Format concatenates multiple segments of a sequence waveform</i>	<i>Format allows dual-array data (Extrema or complex FFT) to be stored</i>
Spreadsheet	Yes	Yes	Yes	Yes	Yes	Yes
MathCad	Yes	Yes	Yes	Yes	Yes	Yes
MATLAB	No	No	Yes	No	Yes	No

SAVE IN AN ASCII FORMAT

Store waveforms in ASCII and save them to a floppy disk or optional storage device in the PC Card slot. Save in an ASCII data format such as Spreadsheet. Then transfer the data to PC.

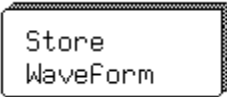
1. Press  and then the button for 

2. Press the button to select 



3. Then use these and the menus on the next page to save your displayed waveform to a storage device in an ASCII data format.

 To select **ASCII**.

 Next, to access the menu shown on the next page and setup for the preferred ASCII format.

 To select or turn off automatic storing features: **Wrap** stores continuously, discarding the oldest files on a 'first-in: first-out' basis. **Fill** stores until the storage device is full.

 To save the waveform selected to the portable storage device using the menus below





To select the memory in which the waveform to display is stored.

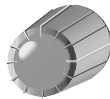



To select the storage device on which the waveform will be stored: floppy disk (**Flpy**) is standard on all Waverunner models, while a PC memory card or hard disk card in the rear PC Card slot (**Card**) is an option.

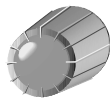



This menu is displayed when you select Setup ASCII Format from the menus shown on the previous page.



To select an ASCII format.

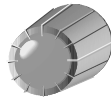
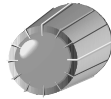

RETURN



To go back to the STORE WFORM menu and make other selections.

Use ASCII Formats

SAVE TO SPREADSHEET

To read a waveform stored in the Spreadsheet format into Microsoft Excel, use: **F**ile -> **O**pen dialog:

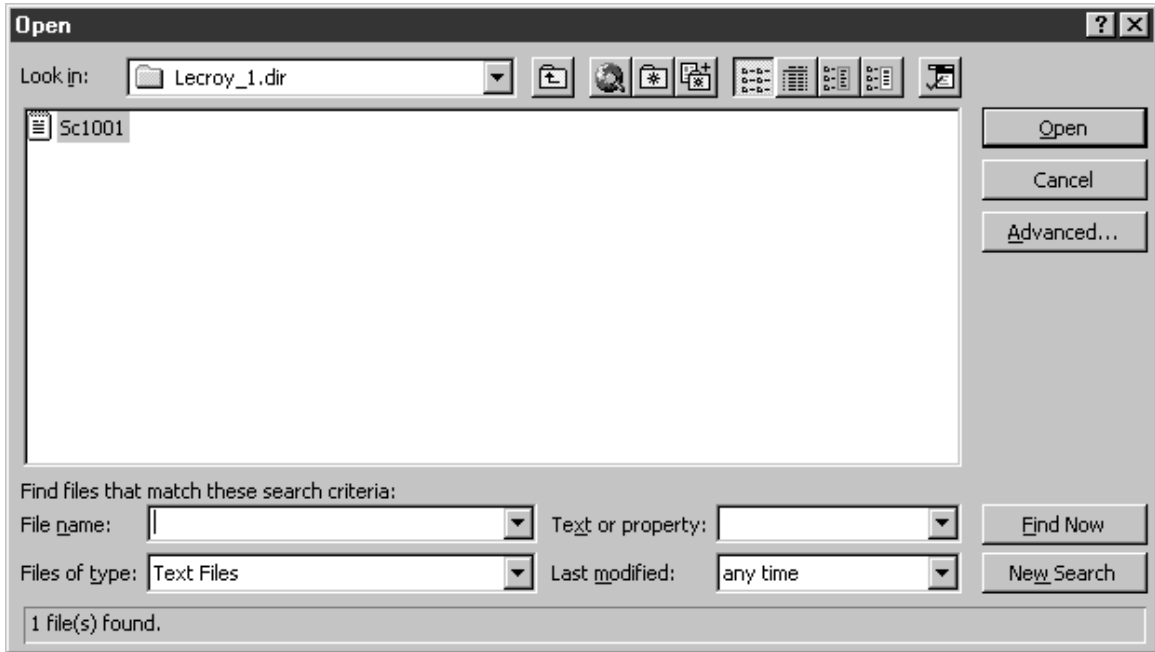

Excel's Text Import Wizard will take you through the following steps:

PART TWO: LOOKING DEEPER

1. Select **Delimited**.

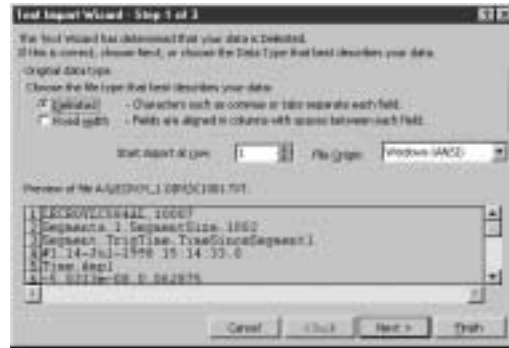

2. The Spreadsheet format generated by WaveRunner uses “,” to delimit columns. Select **Comma** as the delimiter.



3. The third and final step allows you to specify the format of the columns. Select the **General** Column data format (the default).



- Click the **Finish** button: a display similar to this one will be shown:

	A	B	C	D
1	LECROYLC584AL	10007		
2	Segments	1	SegmentSize	1002
3	Segment	TrigTime	TimeSinceSegment1	
4	#1	14-Jul-1998 15:14:33	0	
5	Time	Ampl		
6	-5.03E-08	0.062875		
7	-4.98E-08	0.062875		
8	-4.93E-08	0.061625		
9	-4.88E-08	0.06225		
10	-4.83E-08	0.05975		
11	-4.78E-08	0.060375		
12	-4.73E-08	0.059125		
13	-4.68E-08	0.0585		
14	-4.63E-08	0.057875		

PART TWO: LOOKING DEEPER

PLOT A WAVEFORM IN SPREADSHEET

Plotting the data from a waveform will demand a scatter plot based on the data in the first two columns, with the first column used as the X values (from row 6 in this example):

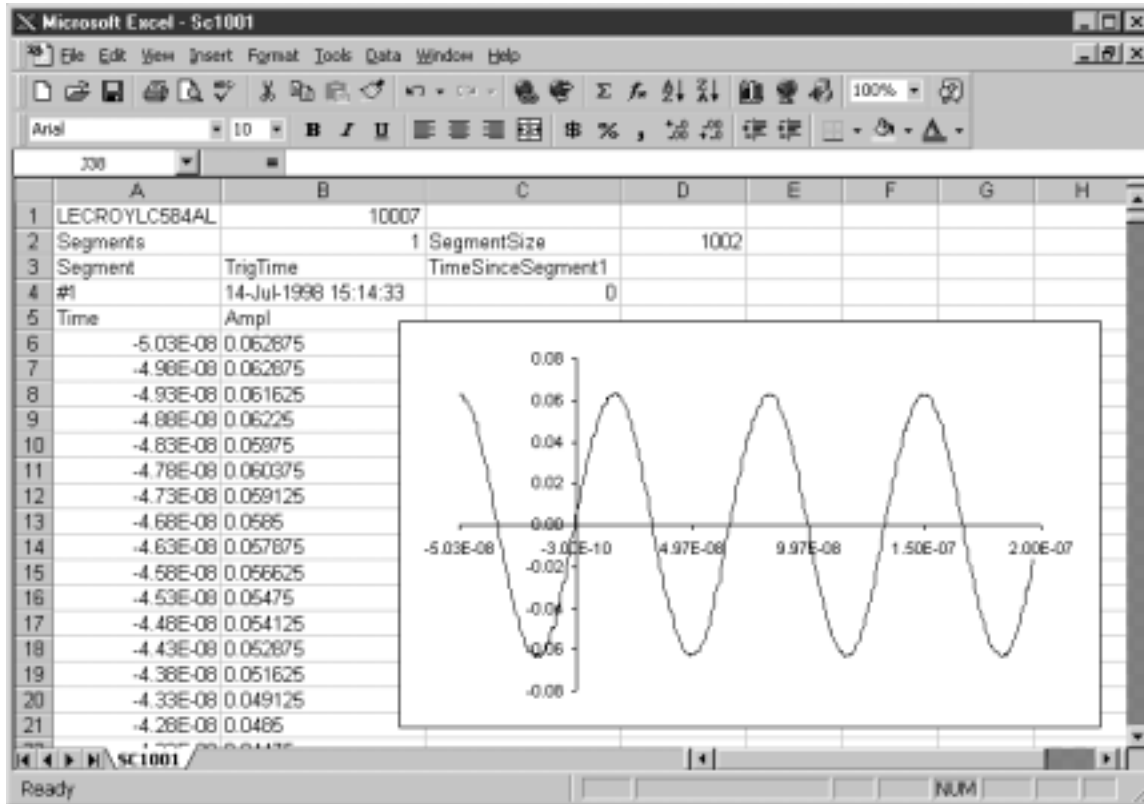

The header created for the spreadsheet contains all the information you'll need to extract various elements from a sequence waveform. Use the following formulae to extract information such as the start and end row of the data for a given segment, or the trigger time of a given segment:

$$\text{SegmentStartRow} := (\text{DesiredSegment} * \text{D2}) + \text{B2} + 5$$

$$\text{SegmentEndRow} := \text{SegmentStartRow} + \text{D2} - 1$$

$$\text{TrigTime} = \text{INDIRECT}(\text{ADDRESS}(\text{DesiredSegment} + 3; 2; 4))$$

$$\text{TimeSinceFirstTrig} = \text{INDIRECT}(\text{ADDRESS}(\text{DesiredSegment} + 3; 3; 4))$$

Plotting the data from all segments using a scatter plot will result in all segments overlaid, as in the Waverunner's persistence display of sequence traces.

USE MATHCAD

These examples were created using MathSoft's MathCad for Windows. Shown on this page is the procedure for reading and graphing a file for a single segment; the example on page 172 is for multiple segments.

This single-segment example is valid for MathCad Versions 3.1 to 7:

$A := \text{READPRN}(\text{file})$

$K := \text{last}(A^{<0>})$

$A := \text{submatrix}(A, 2, K, 0, 1)$

Create a submatrix containing data but no header

$t := A^{<0>}$

Extract time vector

$v := A^{<1>}$

Extract amplitude vector

$K := \text{last}(t)$

Determine index of last point

$k := 0..K - 1$

Create a ramp

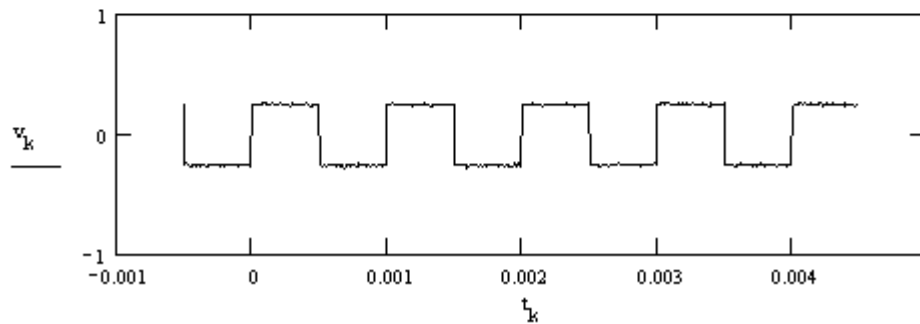

PART TWO: LOOKING DEEPER

This multi-segment MathCad example demonstrates how to extract data from a given segment. The data consisted of two segments of three samples each, allowing the entire imported matrix to be shown:

Read data from file

$a := \text{READPRN}(ac1000)$

Extracting the first segment only (or only segment if not sequence trace)

$n := (1 + a_{0,0}) \cdot (a_{0,0} + a_{0,1})$

$m := 0..1$

$\text{firstseg}_{n-1 - a_{0,0} : m} := a_{n,m}$

$\text{firstseg} = \begin{pmatrix} 1 & 1 \\ 1.1 & 2 \\ 1.2 & 3 \end{pmatrix}$

n

$\begin{pmatrix} 3 \\ 4 \\ 5 \end{pmatrix}$

$a = \begin{pmatrix} 2 & 3 \\ 1 & 0 \\ 2 & 999 \\ 1 & 1 \\ 1.1 & 2 \\ 1.2 & 3 \\ 1 & 1.1 \\ 1.1 & 2.1 \\ 1.2 & 3.1 \end{pmatrix}$

Extracting a given segment

$\text{numsegments} := a_{0,0}$

Total number of segments in trace

$\text{seglen} := a_{0,1}$

Number of samples in each segment

$\text{segment} := 0$

Desired segment number

$\text{segstart} := 1 + \text{numsegments} \cdot \text{segment} - \text{seglen}$

Index of first point in segment

$\text{segend} := \text{segstart} + \text{seglen} - 1$

Index of last point in segment

$\text{segtime} := a_{\text{segstart}+1,1}$

Segment trigger time

$x := a^{<0>}$

$y := a^{<1>}$

$i := \text{segstart}.. \text{segend}$

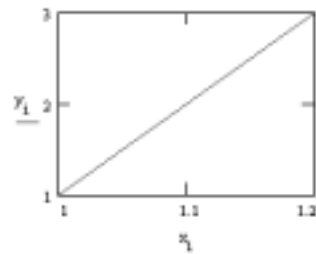

USE MATLAB

This example was created using MathWorks' MATLAB Version 4.2c.1 for Windows. You can read and graph a waveform in MATLAB by using two simple commands: the first loads the file into a matrix automatically named after the file (command window); the second plots this matrix ("Figure No. 1"):

A screenshot of the MATLAB Command Window. The title bar reads "MATLAB Command Window". The menu bar includes "File", "Edit", "Options", "Windows", and "Help". The text area contains the following commands:

```
Commands to get started: intro, demo, help help
Commands for more information: help, whatsnew, info, subscribe

>> load a:\lecroy_1.dir\sc1000.dat
>> plot(sc1000)
>>
```

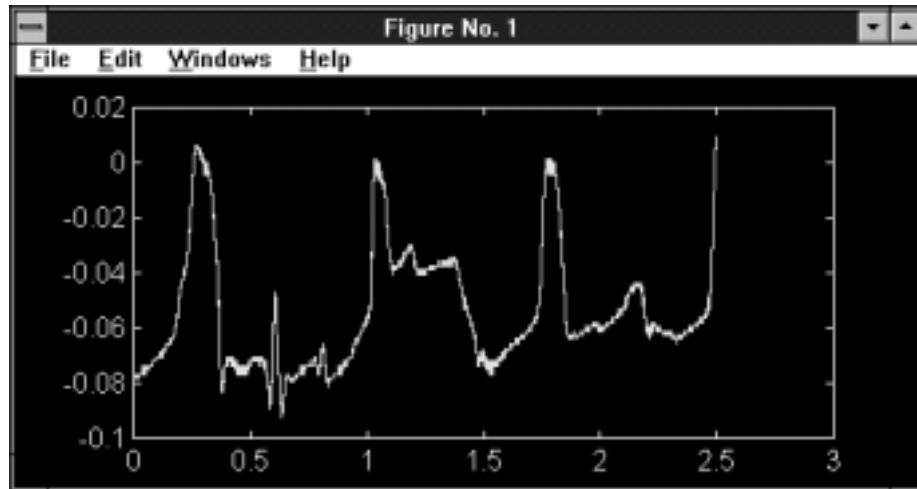

The MATLAB format is simple: it has no header information, only amplitude values. Multiple segments will be appended without a separator. Only one value from the pair of amplitude values present in a dual-array will be stored.



BLANK PAGE



PART THREE

WAVE ANALYZER

(WAVA OPTION)

CHAPTER THIRTEEN: *Parameters*

In this chapter, see how

To set up for histograms

A Valuable Tool for Waveform Analysis

The WaveAnalyzer option added to your Waverunner oscilloscope provides a valuable tool for data analysis and the interpretation of measurement results: the histogram. With WAVA, histograms of waveform parameter measurements can be created, statistical parameters determined, and graphic features quantified for analysis.

Statistical parameters such as mean, standard deviation and median are extremely useful, but alone are usually insufficient for determining whether measured data distribution is as expected (see Chapters 4 and 11). Histograms expand the use of parameters to enhance your understanding by offering visual assessment of this distribution and revealing: **distribution type**, such as normal or non-normal, helpful for determining whether the signal behaves as expected; **distribution tails and extreme values**, which can be observed, and which may be related to noise or other infrequent and non-repetitive sources; and **multiple modes**, observable and possibly indicative of multiple frequencies or amplitudes, which can be used to differentiate from other sources such as jitter and noise.

SET UP FOR HISTOGRAMS

Histograms are based on settings that include bin width and number of parameter events. The Waverunner scope with WAVA uses special parameters for determining histogram characteristics such as mean, median, standard deviation, number of peaks and most populated bin.

But before you can create a histogram, you must first set up the parameters you have chosen:

4. Press  to display the MEASURE menus.

5. Press the button to select **Parameters**, and the button for  mode

Use  statistics if desired.

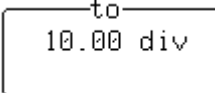
6. Set start and end points for the measurements with  From 0.00 div Track OFF On and  to 10.00 div

PART III: WAVE ANALYZER

Parameters are used to perform waveform measurements for the section of a waveform lying between the parameter cursors (Fig 1.1, item ❶). The position of the parameter cursors is set using the **from** and **to** menus, and controlled by the associated menu knobs. The top trace in the figure below shows a sine wave on which a **freq** parameter measurement (❷) is being performed, with a value of 202.442 kHz as the average frequency. The bottom trace shows a histogram of this parameter and a value of 201.89 kHz (❸) — the average frequency of the data contained within the parameter cursors.

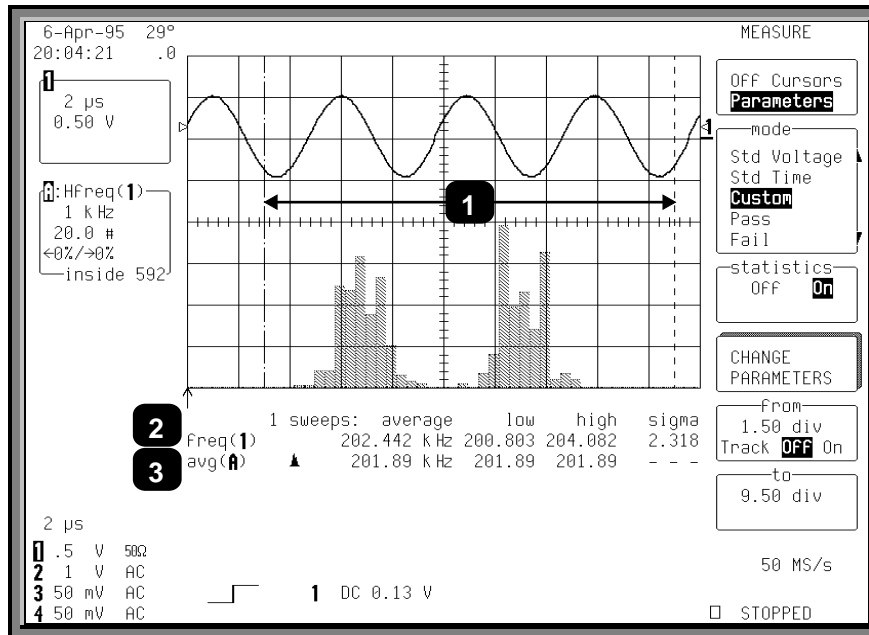

Figure 1.1

4. Press the button to select



and access the CHANGE PARAM menus.

As shown in Figure 1.2, up to five parameters can now be selected, each displayed on its own line below the grid. Categories are provided for related groups of parameter measurements. The freq measure parameter from the “Cyclic” category for Trace 1, previously selected, is displayed on Line 1 as **freq(1)** (Item 1). The **avg** measure parameter from the “Statistics” category for Trace A is displayed on Line 2. This category provides histogram parameters, while avg offers the mean value of the underlying measurements for the Trace A histogram section within the parameter cursors (2), shown as “avg(A)” in 3. Additional parameter measurements can be selected from “Category” and “measure”. No parameters have been selected for Lines 3 to 5

5. After selecting a category, choose a parameter from the “measure” menu. Then select the parameter display line from the “On line” menu.

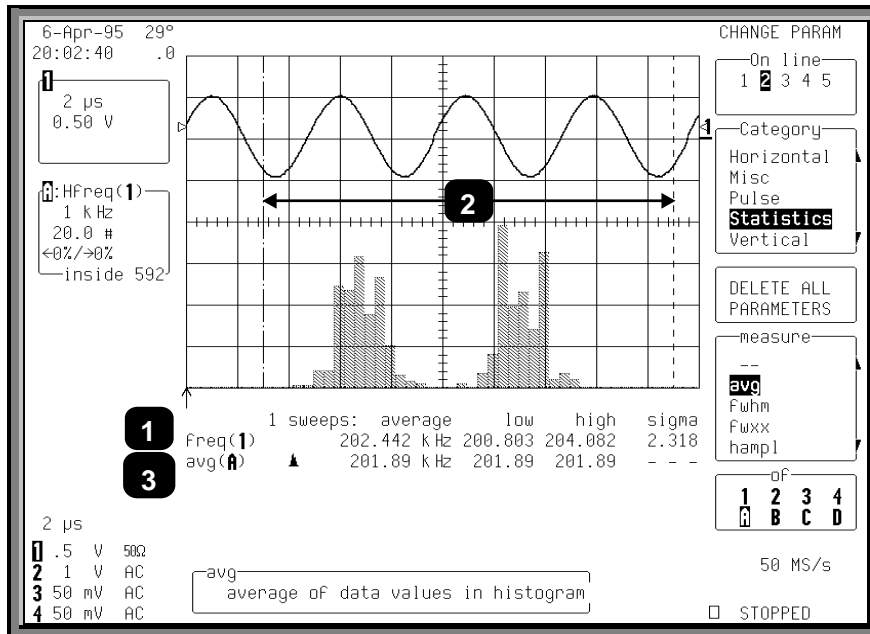

Figure 1.2

If a parameter has additional settings that you must supply in order to perform measurements, the **MORE ‘xxxx’ SETUP** menu appears. But if no additional settings are required the **DELETE ALL PARAMETERS** menu appears, as shown here; pressing the associated menu button clears the results in all five lines of parameters.

PARAMETER-VALUE CALCULATION AND DISPLAY



When you are not using persistence, the display for input channels shows the captured waveform of a single sweep. For non-segmented waveforms, the display is identical to a single acquisition. But with segmented waveforms, the result of a single acquisition for all segments is displayed.

The value displayed for a chosen parameter depends on whether “statistics” is on or off. And on whether the waveform is segmented. These two factors in addition to the parameter chosen determine whether results are provided for a single acquisition (trigger) or multiple acquisitions. In either case, only the waveform section between the parameter cursors is used.

If the waveform source is a memory (M1, M2, M3, or M4) then loading a new waveform into memory acts as a trigger and sweep. This also applies when the waveform source is a zoom of an input channel, and when a new segment or the “All Segments” menu is selected.

With “statistics” off, the parameter results for the last acquisition are displayed. This corresponds to results for the last segment for segmented waveforms with all segments displayed. For zoom traces of segmented waveforms, selection of an individual segment gives the parameter value for the displayed portion of the segment between the parameter cursors. Selection of “All Segments” provides the parameter results from the last segment in the trace.

With “statistics” on, and where the parameter does not use two waveforms in calculating a result (Δdly , $\Delta t@lv$), results are shown for all acquisitions since the CLEAR SWEEPS button was last pressed. If the parameter uses two waveforms, the result of comparing only the last segment per sweep for each waveform contributes to the statistics.

The statistics for the selected segment are displayed for zoom traces of segmented waveforms. Selection of a new segment or “All Segments” acts as a new sweep and the parameter calculations for the new segment(s) contribute to the statistics.

*Depending on the parameter, single or multiple calculations can be performed for each acquisition. For example, the period parameter calculates a period value for each of up to the first 50 cycles in an acquisition. When multiple calculations are performed, with “Statistics” **Off** the parameter result shows the average value of these calculations. Whereas **On** displays the average, low, high, and sigma values of all the calculations.*

In Figure 1.3, below, the upper trace shows the persistence display of a signal. The initial suggestion is of frequency drift in the signal source. The lower trace shows a histogram of the frequency as measured by the oscilloscope

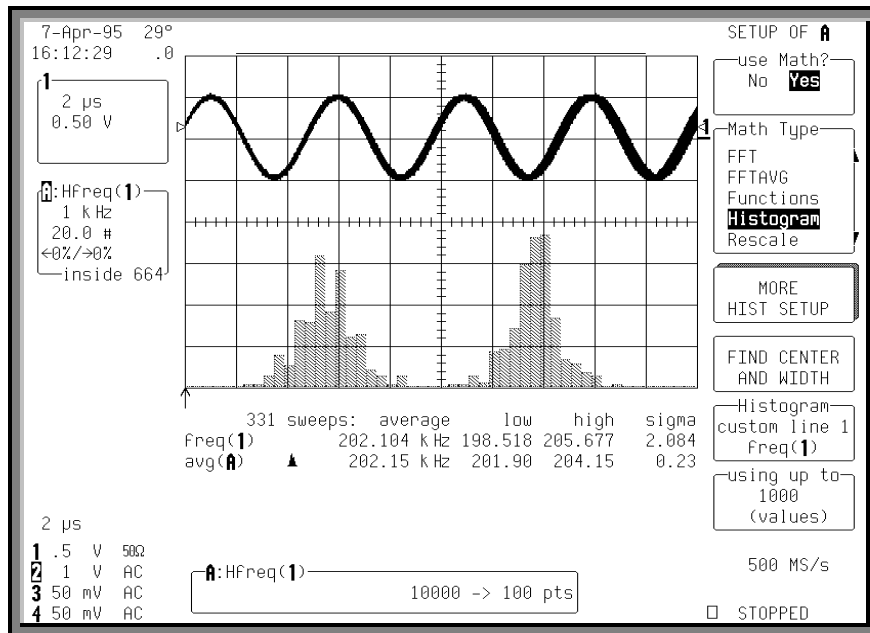

Figure 1.3

This histogram indicates two frequency distributions with dominant frequencies separated by 4000 Hz. There are two distinct and normal looking distributions, without wide variation, within each of the two. We can conclude that there are two dominant frequencies. If the problem were related to frequency drift, the distribution would have a tendency to be broader, non-normal in appearance, and normally there would not be two distinct distributions.

After a brief visual analysis, the measurement cursors and statistical parameters can be used to determine additional characteristics of distribution, including the most common frequency in each distribution and the spread of each distribution.

PART III: WAVE ANALYZER

Figure 1.4, below shows the use of the measurement cursor (Item ①), to determine the frequency represented by one bin of the distribution. The value of the bin, inside the Displayed Trace Field is indicated by ②.

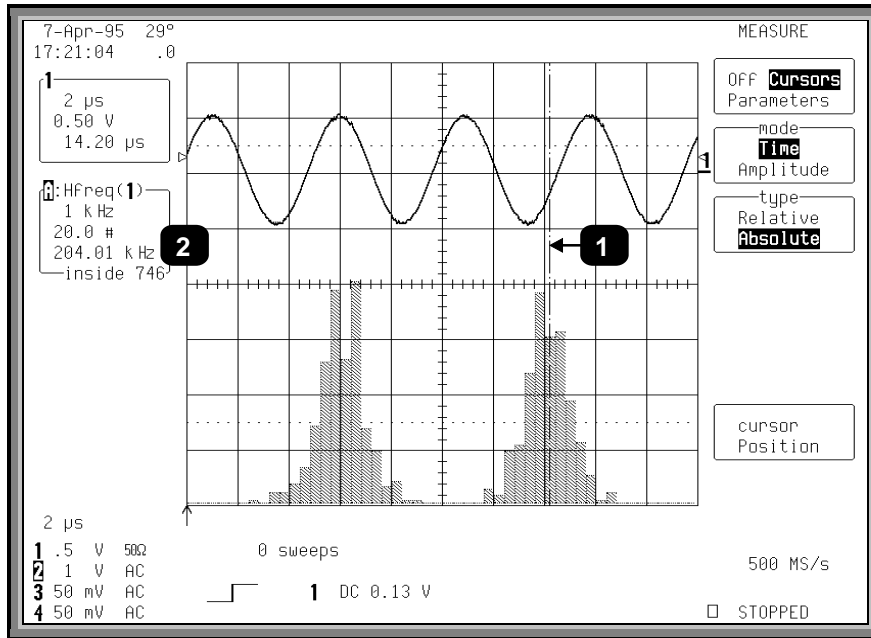

Figure 1.4

Figure 1.5, below shows the use of the parameter cursors (Items ❶ and ❷) in determining the average frequency of the distribution located between the cursors. The average value of the measurements in the right-hand distribution is indicated by ❸.

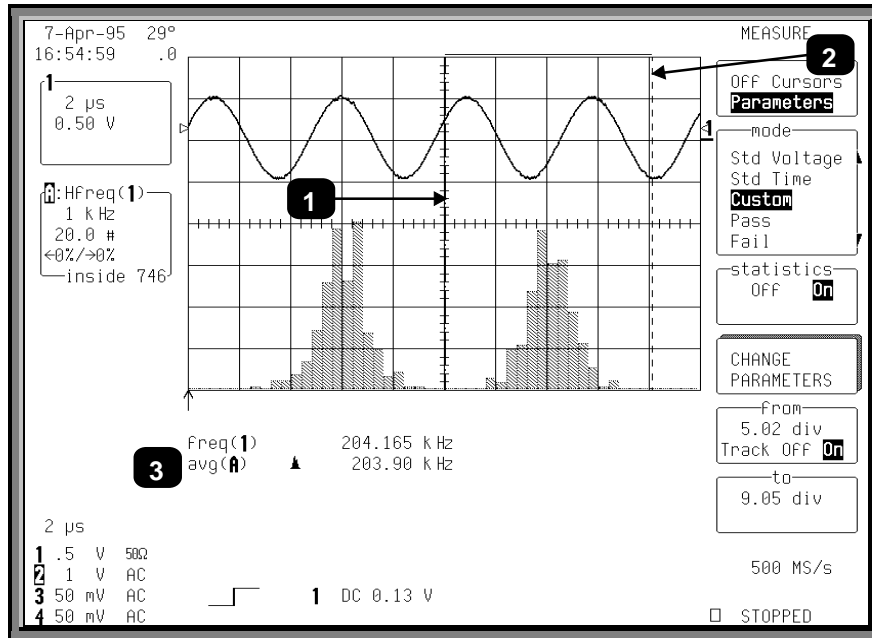

Figure 1.5

PART III: WAVE ANALYZER

Finally, Figure 1.6 shows the use of the measurement cursors (Items ① and ②) in determining the difference in frequency between a bin in the center of each distribution. The value in kHz, in the Displayed Trace Field, is indicated by ③.

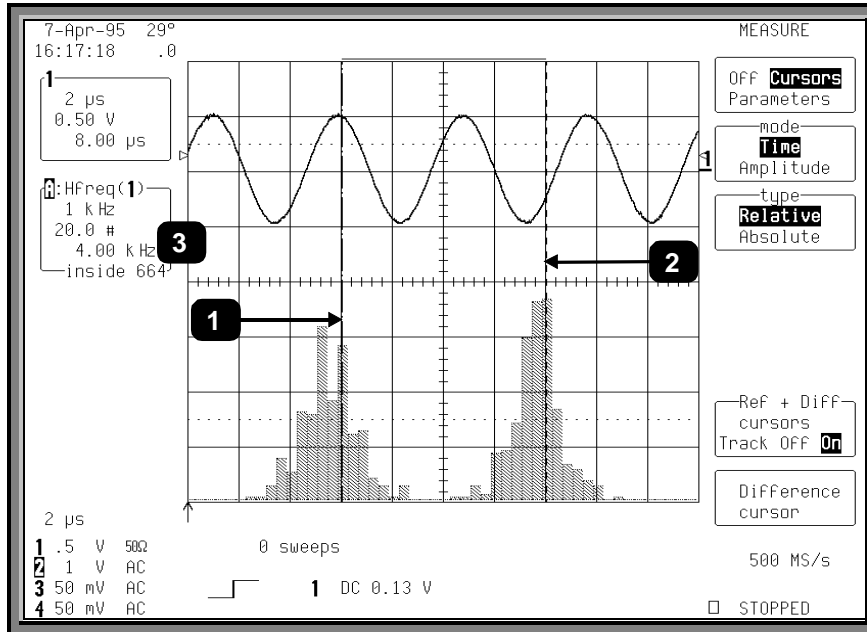

Figure 1.6

Parameter Math

LeCroy's WaveAnalyzer option also gives you the ability to perform arithmetic operations (addition, subtraction, multiplication, division) on the results of two parameter measurements. By customizing parameters in this way, you can effectively extend the range of parameter measurements based on your particular needs.

For example, suppose you need to measure the crest factor of a waveform. Traditionally, you would select the peak-to-peak and rms parameters, then manually compute the ratio of peak-to-peak to rms. Figure 1.7, on the other hand, shows how parameter math was used to configure crest factor as a calculated parameter. The list of custom parameters comprises 5 calculated parameters labeled **calc1** through **calc5**.

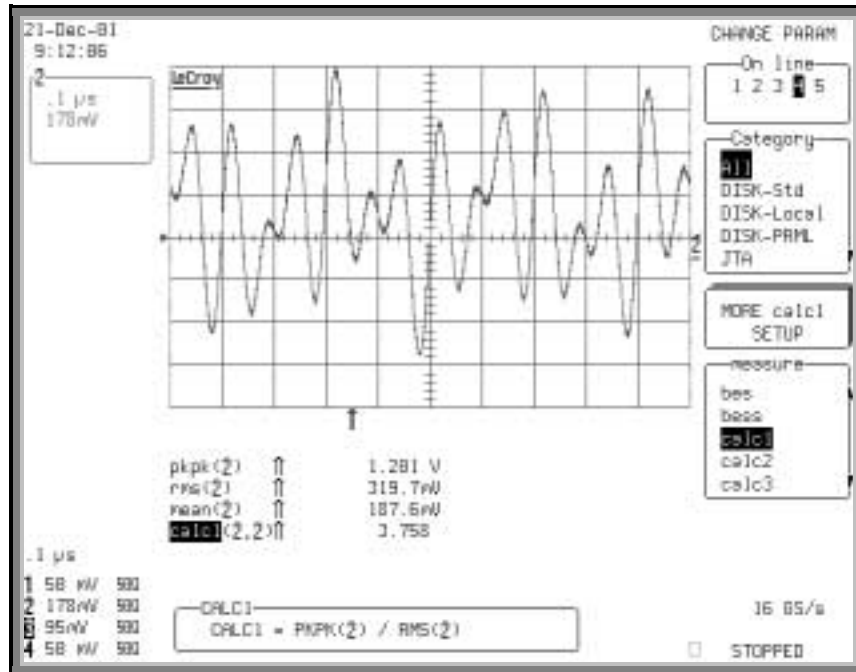

Figure 1.7. Calculated parameters allow the creation of custom parameters. Here *calc1* is set up to measure crest factor (peak-to-peak/rms).

Selecting the calculated parameter **calc1** from the "measure" parameter menu allows you to set it up, as shown in Figure 1.8. Here the parameters, source waveforms, and arithmetic operator can be selected. The *calc1* parameter has been set up to display the ratio of peak-to-peak to rms for channel 2. This is shown in the "calc1" summary box under the grid.

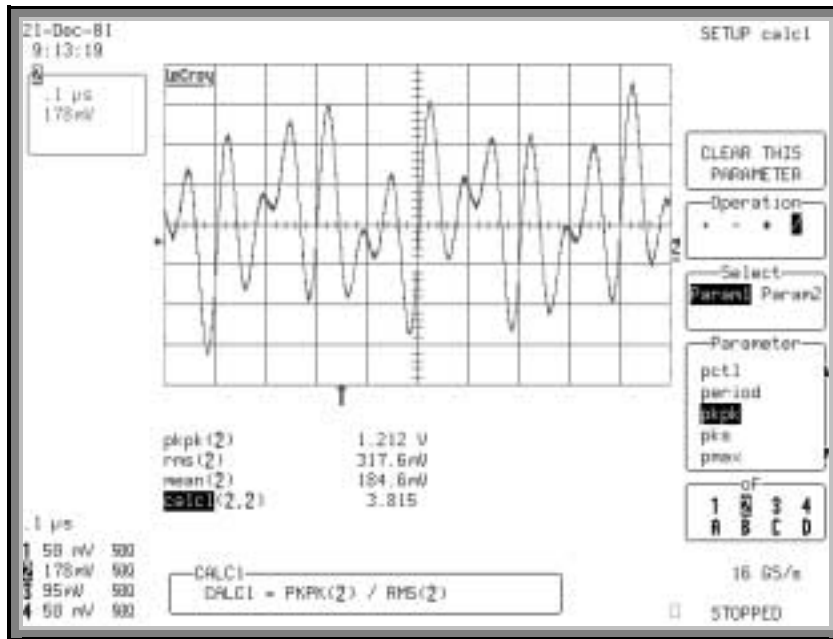

Figure 1.8. Defining Calc1 to Read the Crest Factor of Channel 2

The five calculated parameters compute new parameters based on any two parameters operating on any combination of the acquisition channels or math/zoom traces. The source parameters do not have to be displayed.

Figure 1.9 is an example of setting up a direct measurement of the modulation index of an FM signal. Phase modulation has been performed using the JitterTrack™ of time interval error (TIE) of the input signal from channel 2. Differentiation and rescaling convert the TIE function into the demodulated FM signal. The TIE function is multiplied by the carrier frequency of 400 MHz. This results in a display of frequency deviation versus time. Because the ratio of $1/2$ the peak-to-peak frequency deviation is required for the FM modulation index, TIE must also be divided by 2. All this is done in Trace D, using the rescale function to multiply by $2 * E^8$ (400 MHz/2). In general, all additive or multiplicative constant operations in the calculated parameters require the rescale function. (In this example the rescale operation was required anyway.)

Figure 1.10 shows the setup of calculated parameter **calc5** to read the FM modulation index by taking $1/2$ the peak-to-peak frequency deviation divided by the modulation frequency. Both parameters are derived from trace D.

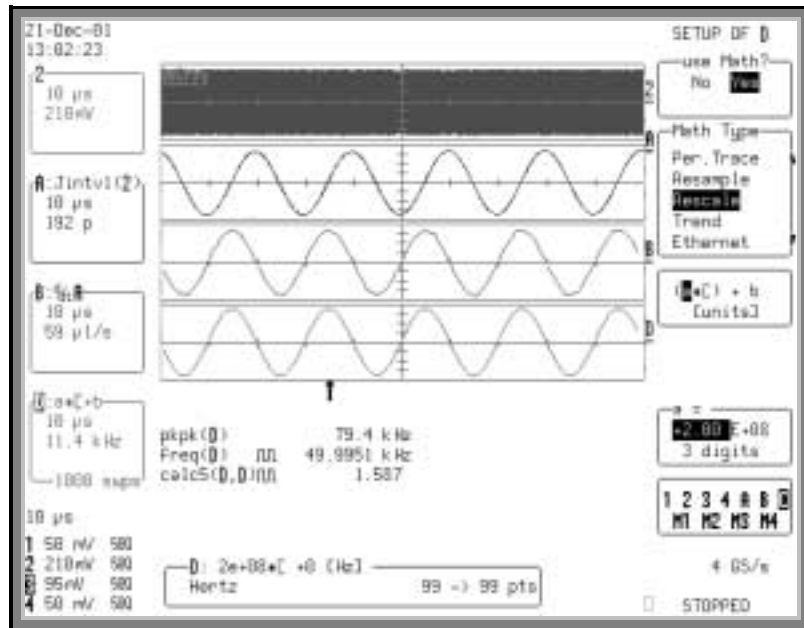

Figure 1.9. Using Rescaling to Convert TIE to a Display of Frequency Deviation

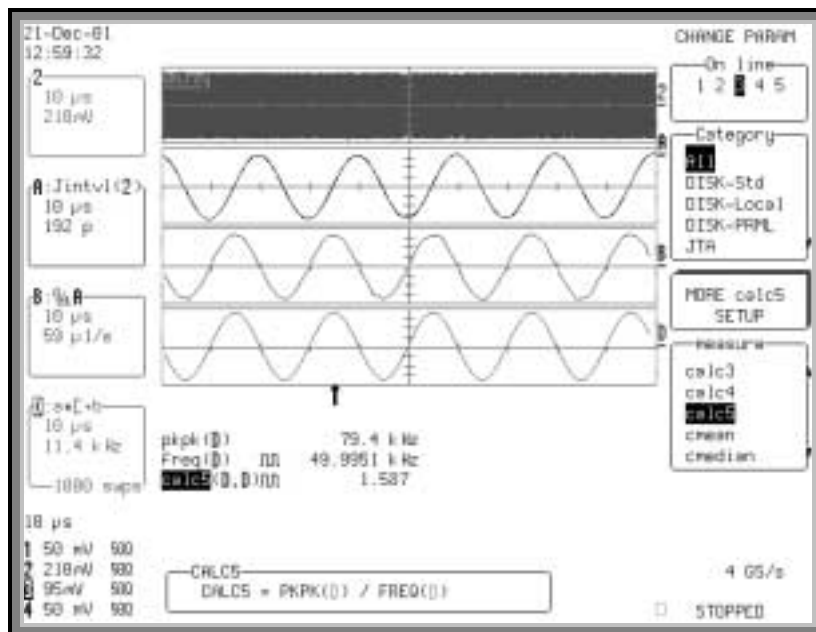

Figure 1.10. Setting Calc5 to Measure FM Modulation Index

LOGARITHMIC PARAMETERS

The Parameter Math option prevents multiplication and division of parameters that return logarithmic values. These parameters are as follows:

- auto-correlation signal-to-noise ratio (ACSN)
- narrow-band power (NBPW)
- media signal-to-noise ratio (MSNR)
- residual signal-to-noise ratio (RSNR)
- top-to-base ratio when the units are in dB (TBR)

EXCLUDED PARAMETERS

Parameters that are already the result of parameter math operations are excluded, and will not appear in the parameter menu. If they are included in a remote control setup command, an error message is generated and the setup canceled.

- Excluded parameters are as follows:
- beginning edge shift (BES)
- beginning edge shift – list (BES)
- beginning edge shift sigma (BEES)
- beginning edge shift sigma – list (BEES)
- delta clock-to-data near (DC2D)
- delta clock-to-data next (DC2DPOS)
- delta clock-to-data previous (DC2DNEG)
- delta delay (DDL)
- delta pit-to-clock (DP2C)
- delta pit-to-clock – list (DP2C)
- delta pit-to-clock sigma (DP2CS)
- delta pit-to-clock sigma – list (DP2CS)
- delta time at level (DTLEV)
- end edge shift (EES)
- end edge shift – list (EES)
- end edge shift sigma (EES)
- end edge shift sigma – list (EES)
- phase (PHASE)
- resolution (RES)
- apparent power (APWR)
- mTnTmT shift (BEES)
- mTnTmT shift sigma (BEES)
- mTnTmT shift sigma – list (BEES)
- power factor (PF)
- real power (RPWR)

TO SET UP PARAMETER MATH



1. Press **MEASURE TOOLS**.
2. Press the button for "Parameters." The MEASURE menu panel appears.
3. From the "mode" menu, select **Custom**.
4. Press the button for "Change Parameters." The CHANGE PARAM menu panel appears.
5. From the "On line" menu, select the line (**1** through **5**) below the grid on which you want to show the calculation result.
6. From the "Category" menu, select **All**.
7. From the "measure" menu select, **calc x** (**calc1** through **calc5**).
8. Press the button for "More Calc x Setup." The SETUP CALC x menu panel appears.
9. If the current calc parameter is already defined and you want to redefine it, press the button for "CLEAR THIS PARAMETER."
10. From the "Operation" menu, select an arithmetic operator (+, -, *, /).
11. To set the first parameter in the equation, select **Param1** from the "Select" menu. Then choose a parameter from the "Parameter" menu.
12. Set the second parameter in the equation by selecting **Param2** from the "Select" menu. Then choose a parameter from the "Parameter" menu.







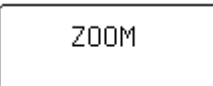

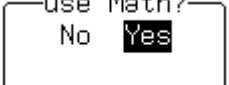
BLANK PAGE

Create and View a Histogram

Create your histogram as you would any other Math function: by defining trace A, B, C, or D as the function. Having connected your signal to a Waverunner channel (Channel 1 in this example), do the following:

1. Press  to select CHANNEL 1 and display the basic Waverunner menus.
2. Press the button to  and  to make Trace A a zoom of Channel 1.
3. Press the button for  and select  to display SETUP OF A.
4. Use these and the menus on the following pages to set up your histogram.

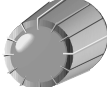

-  To select for math.
-  To select **Histogram**.
-  To select parameters and further configure the histogram (see next page).
-  For calculating optimal center- and bin-width values for the histogram.
-   To select the parameter line to be used in the histogram.
-   To select — using button or knob — the number of values in the histogram. When the maximum of two billion values is exceeded, the parameter results will scroll off the histogram.

HISTOGRAMS

TIP: As with any other trace, position and expand your histogram using **POSITION** and **ZOOM** knobs

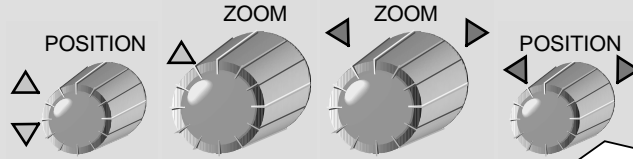

HISTOGRAM A

Setup
Binning
 Scale

PARAMETER
 SETUP

FIND CENTER
 AND WIDTH

classify into
 2000
 (bins)



To adjust either the histogram binning or scale settings. When **Binning** is selected, the menus shown here appear.



NOTE: When using these knobs, values in the “Center” and “Width” menus do not change, since they determine the range of the histogram and cannot be used to determine the parameter value range of a particular bin. If the histogram is repositioned using the horizontal POSITION knob the histogram’s center will be moved from the center of the screen. (MEASURE TOOLS should then be used.)



To access the CHANGE PARAM menus and select or configure a parameter for histogramming. See Chapter 11, “Parameter Analysis.”



For calculating optimal center- and bin-width values for the histogram.

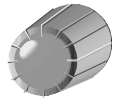

For choosing the number of bins into which the parameter events are to be classified, or distributed.

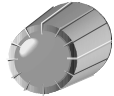

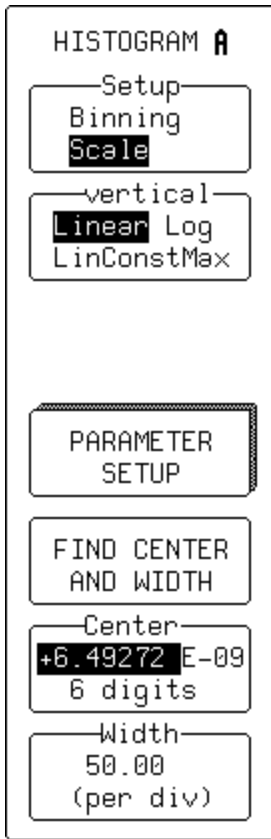

To adjust either the histogram binning or scale settings. When **Scale** is selected, the menus shown here appear (see page 197).



For setting the vertical scale: **Linear** sets a linear vertical scale, **Log** a logarithmic vertical scale, and **LinConstMax** the vertical scaling to a linear value that uses close to the full vertical display capability of the instrument.



Waverunner automatically increases the vertical scale setting as required, ensuring that the highest histogram bar does not exceed the vertical screen display limit.



To select parameters and configure the histogram.



For calculating optimal center- and bin-width values for the histogram.

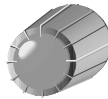

To set the histogram center value.

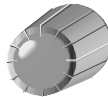

To set the histogram width value per division. The width per division multiplied by the number of horizontal display divisions (ten) determines the range of parameter values centered on the number in the “Center” menu, used to create the histogram.

HISTOGRAMS

Figure 2.1, below, shows the display when “Histogram” is selected from the “Math Type” menu. The freq parameter only has been defined. To define additional parameters, select from the “Histogram custom line” menu.

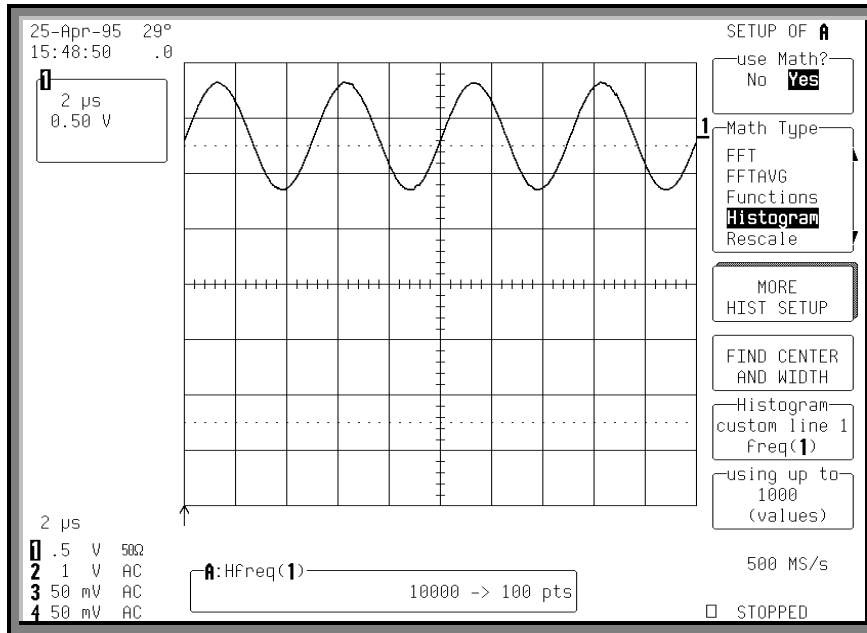

Figure 2.1

Each time a waveform parameter value is calculated you can place it in a histogram bin. The maximum number of such values is selected from the “using up to” menu. Pressing the associated menu button or turning the knob allows you to select a range from 20 to two billion parameter value calculations for histogram display.

5. Now, press **A** to display the histogram, for a display similar to that shown in Figure 2.2.

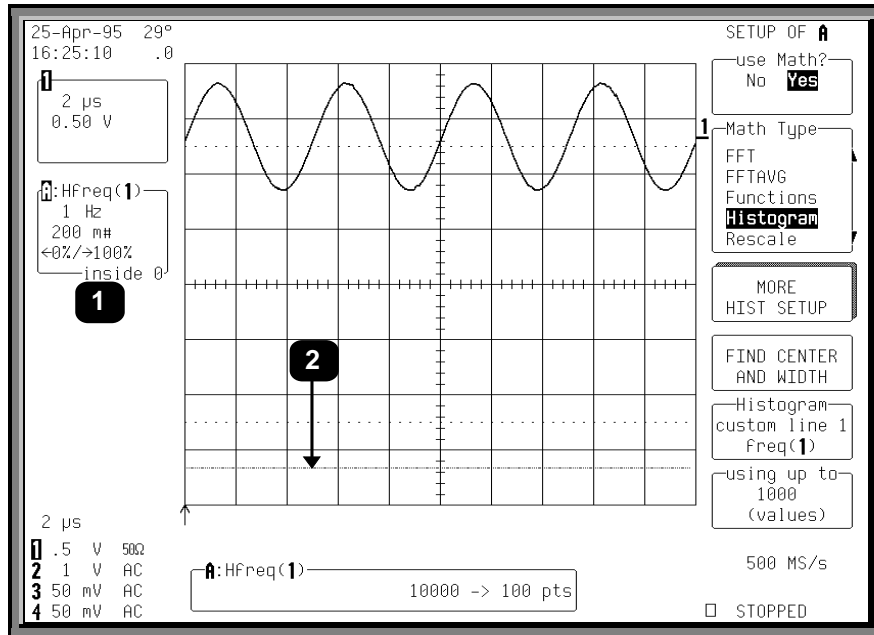

Figure 2.2

Each histogram is set to capture parameter values falling within a specified range. As the scope captures the values in this range the bin counts will increase. Those values not falling within the range are not used in the histogram.

Information on the histogram is provided in the Displayed trace field (Item ❶) for the selected trace, which shows:

The current horizontal per division setting for the histogram (“1 Hz” in this example). The unit type used is determined by the waveform parameter type on which the histogram is based.

The vertical scale in # bin counts per division (here, “200 m”).

The number of parameter values that fall within the range (“inside 0”)

The percentage that fall below (“←0%”)

The percentage of values above the range (“100%→”).

HISTOGRAMS

The previous figure shows that 100% of the captured events are above the range of bin values set for the histogram. As a result, the baseline of the histogram graph (2) is displayed, but no values appear.

Selecting the “FIND CENTER AND WIDTH” menu calculates the optimal center and bin-width values, based on the up-to-the-most-recent parameter values calculated. Choose the number of parameter calculations with the “using up to” menu (or 20 000 values if this is greater than 20 000). Figure 2.3 shows a typical result.

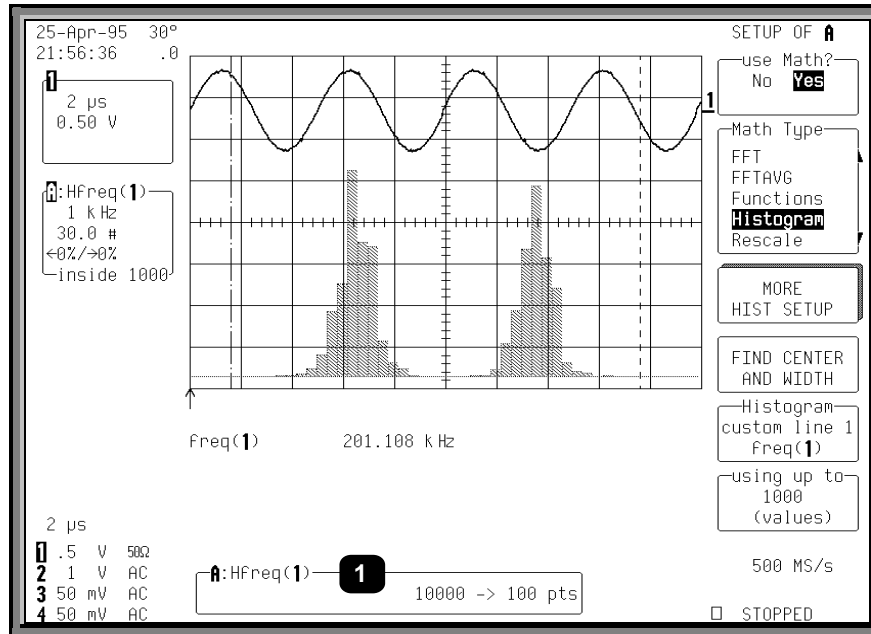

Figure 2.3

If the trace on which you have made the histogram is not a zoom, all bins with events will be displayed.

Otherwise, you can press **RESET** to reset the trace and display all histogram events.

The Information Window (Item 1) at the bottom of the previous figure shows a histogram of the freq parameter for Channel 1 (designated as “A:Hfreq(1)”) for Trace A. The “1000 → 100 pts” in the window indicates that the signal on Channel 1 has 1000 waveform acquisition samples per sweep and is being mapped into 100 histogram bins.

SETTING BINNING AND SCALE

The “Setup” menu allows modification of either the “Binning” or the histogram “Scale” settings. If “Binning” is selected, the “classify into” menu appears, as shown in the figure above.

CHAPTER FOURTEEN: *Making Histograms*

The number of bins used can be set from a range of 20 to 2000 in a 1-2-5 sequence, by pressing the corresponding menu button or turning the associated knob.

If “Scale” is selected from the “Setup” menu, a screen similar to that of Figure 2.4 will be displayed.

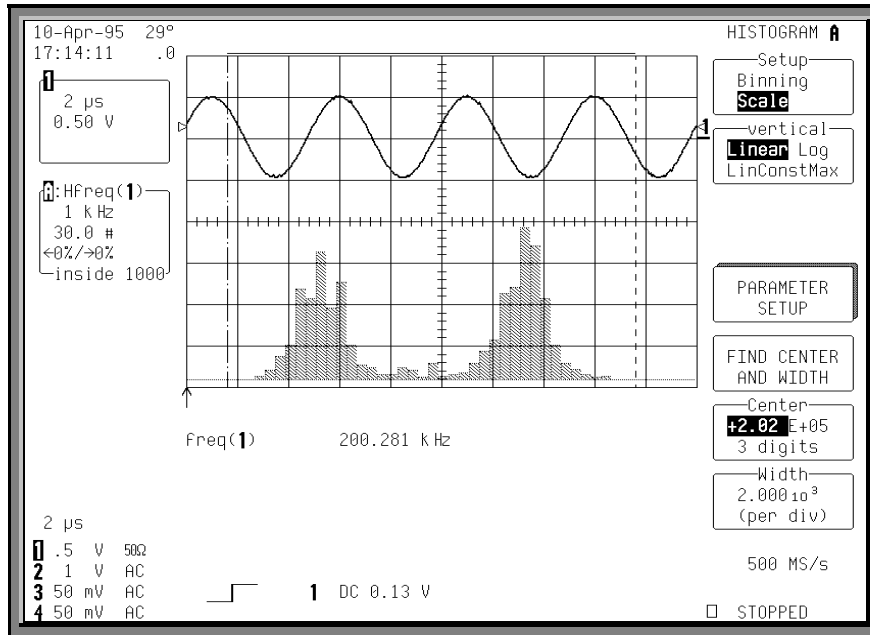

Figure 2.4

The following options are offered by the “vertical” menu for setting the vertical scale:

Linear sets the vertical scale as linear. The baseline of the histogram designates a bin value of 0. As the bin counts increase beyond that which can be displayed on screen using the current vertical scale, this scale is automatically increased in a 1-2-5 sequence.

HISTOGRAMS

Log sets the vertical scale as logarithmic (Fig 2.5). Because a value of '0' cannot be specified logarithmically, no baseline is provided.

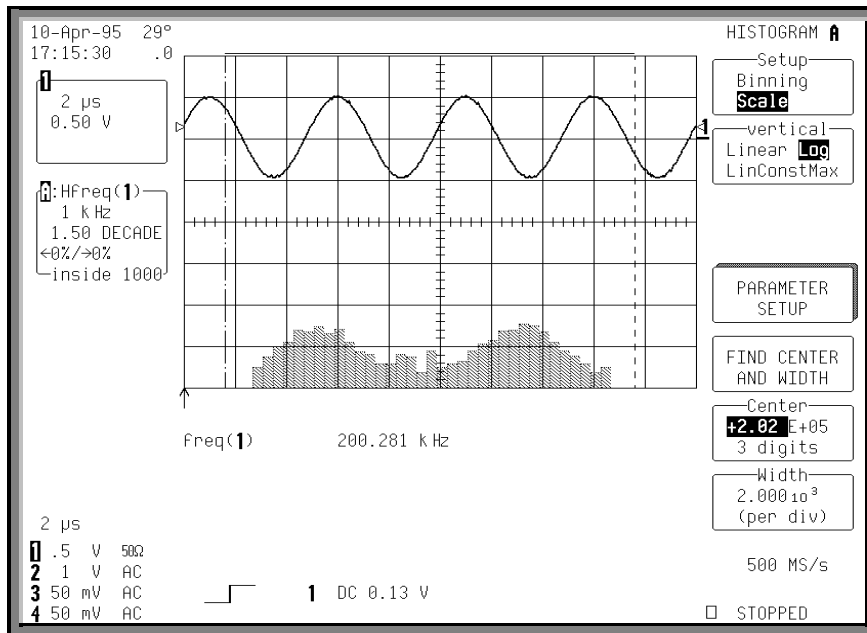

Figure 2.5

LinConstMax sets the vertical scaling to a linear value that uses nearly the full vertical display capability of the scope (Fig. 2.6). The height of the histogram will remain almost constant.

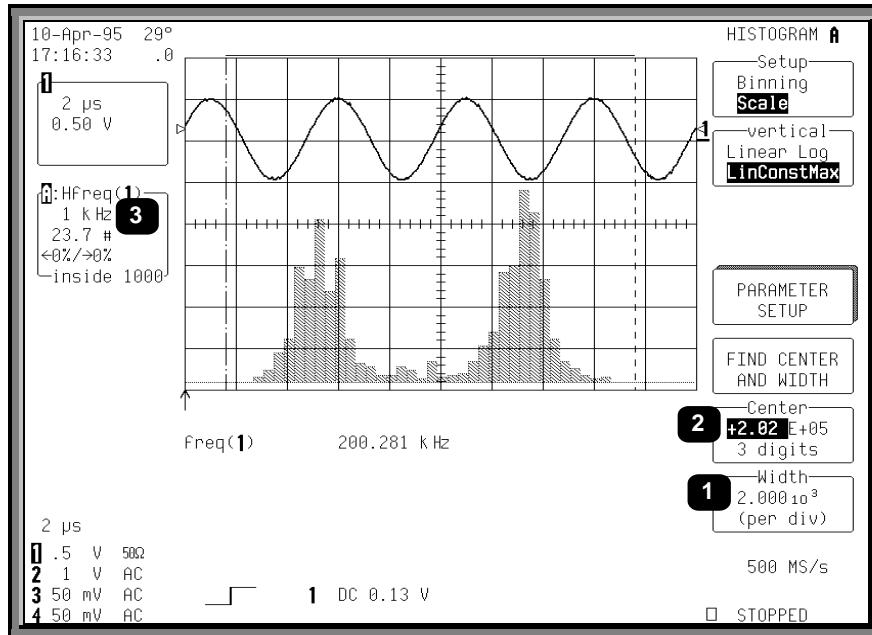

Figure 2.6

For any of these options, the scope automatically increases the vertical scale setting as required, ensuring the highest histogram bin does not exceed the vertical screen display limit.

The “Center” and “Width” menus allow you to specify the histogram center value and width per division. The width per division times the number of horizontal display divisions (10) determines the range of parameter values centered on the number in the **Center** menu, used to create the histogram.

In the previous figure, the width per division is 2.000×10^3 (Item ❶). As the histogram is of a frequency parameter, the measurement parameter is in hertz.

The range of parameter values contained in the histogram is thus $(2 \text{ kHz/division}) \times (10 \text{ divisions}) = 20 \text{ kHz}$, with a center of $2.02 \text{ E}+05 \text{ Hz}$ (❷).

In this example, all freq parameter values within $202 \text{ kHz} \pm 10 \text{ kHz}$ — from 192 kHz to 212 kHz — are used in creating the histogram. The range is subdivided by the number of bins set by the user. Here, the range is 20 kHz , as calculated above, and the number of bins is 100. Therefore, the range of each bin is:

$$20 \text{ kHz} / 100 \text{ bins, or}$$

$$0.2 \text{ kHz per bin.}$$

HISTOGRAMS

The “Center” menu allows you to modify the center value’s mantissa — here 2.02 — exponent (E+05), or the number of digits used in specifying the mantissa (three). The display scale of 1 kHz/division, shown in the Trace Display Field, is indicated by **Ⓢ**. This scale has been set using the horizontal zoom control and can expand the scale for visual examination of the histogram trace.

The use of zoom in this way does *not* modify the range of data acquisition for the histogram, only the display scale. The range of measurement acquisition for the histogram remains based on the center and width scale, resulting in a range of 202 kHz ± 10 kHz for data acquisition.

The width or division can be incremented in a 1-2-5 sequence by selecting “Width.”

CHOOSING HISTOGRAM PARAMETERS

Once you have created the histogram, you can select additional parameter values for measuring particular attributes of the histogram itself.

6. Press the button to select **CHANGE PARAMETERS** and access the CHANGE PARAM menus (Fig 2.7).

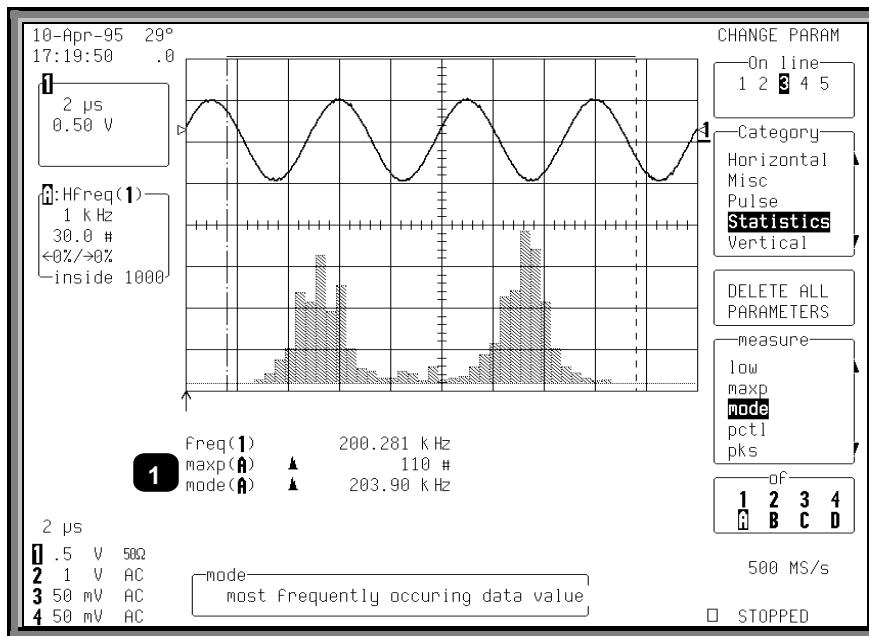

Figure 2.7

CHAPTER FOURTEEN: Making Histograms

You can now select new parameters modify those already selected. In the figure on the previous page, the histogram parameters maxp and mode (Item ❶) have been selected. These determine the count for the bin with the highest peak, and the corresponding horizontal axis value of that bin's center.

Note that both “maxp” and “mode” are followed by “(A)” on the display. This designates the measurements as being made on the signal on Trace A. Also of note:

The value of “maxp(A)” is “110 #”, indicating the highest bin has a count of 110 events.

The value of mode(A) is “203.90 kHz”, indicating that this bin is at 203.90 kHz.

The  icon to the left of “mode” and “maxp” parameters indicates that the parameter is being made on a trace defined as a histogram.

However, if these parameters were to be inadvertently set for a trace with no histogram they would show ‘---’.

USING MEASUREMENT CURSORS

You can use cursors (see Chapter 4) to select a section of a histogram on which a parameter is to be calculated. Figure 2.8 below shows the average, “avg(A)” (Item ❶) of the distribution between the parameter cursors for a histogram of the frequency (“freq”) parameter of a waveform. The parameter cursors (❷) are set “from” 4.70 divisions (❸) “to” 9.20 divisions (❹) of the display.

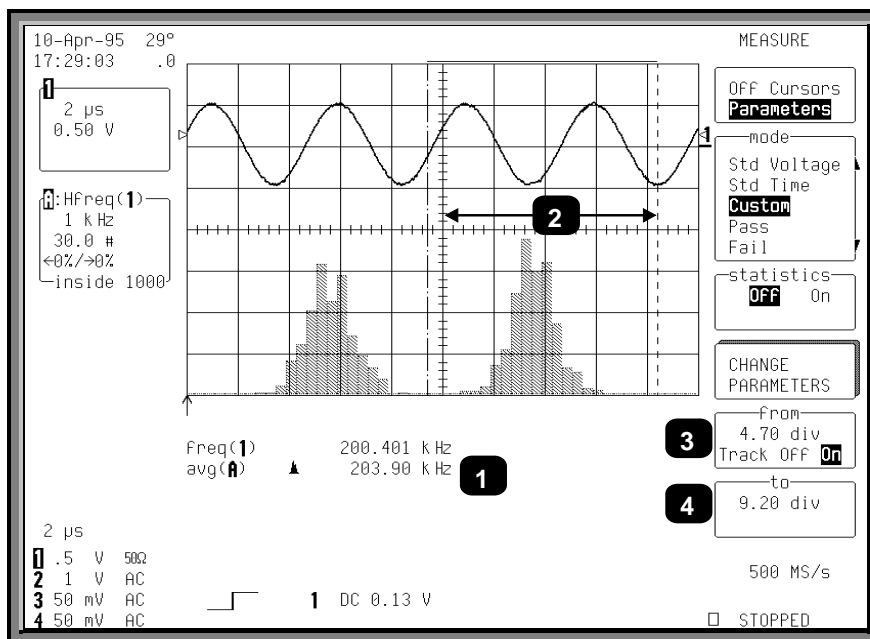

Figure 2.8

HISTOGRAMS

NOTE: It is recommended that you use cursors only after the input waveform acquisition has been completed. Otherwise, the cursors will also select the portion of the input waveform used to calculate the parameter during acquisition, creating a histogram with only the local parameter values for the selected waveform portion.

Cursors are useful for determining the value and population of selected bins. Figure 2.9 shows an absolute time cursor (Item ❶) positioned on a selected histogram bin. The value of the bin (❷) and the population of the bin (❸) are also shown.

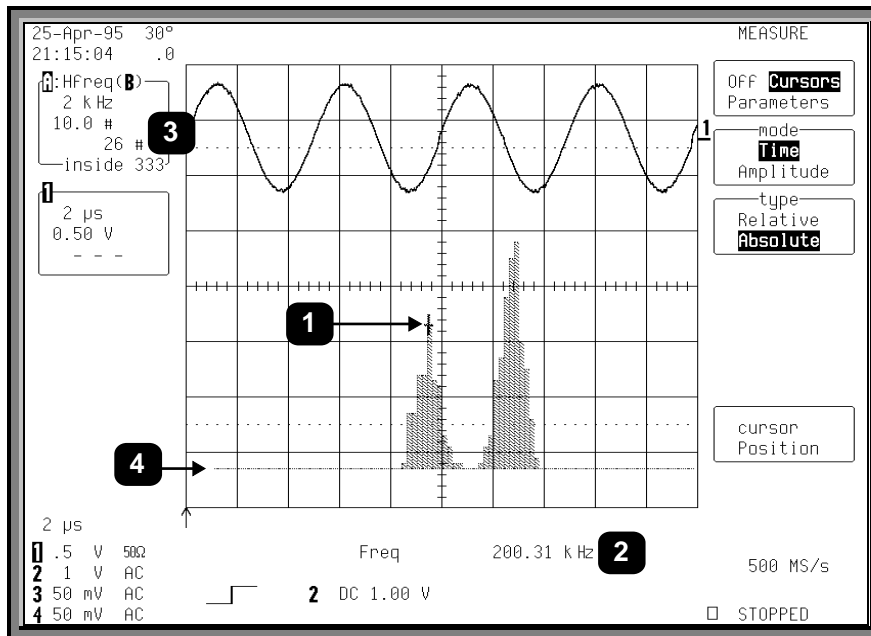



Figure 2.9

A histogram's range is represented by the horizontal width of the histogram baseline. As the histogram is repositioned vertically the left and right sides of the baseline can be seen. In the above figure, the left edge of the range is visible (❹).

CLEAR SWEEPS
TIP: Press  At any time to clear all histogram events in the 20-k parameter buffer at the same time.

ZOOMING SEGMENTED TRACES

You can also display histograms of traces that are zooms of segmented waveforms. When a segment from a zoomed trace is selected, the histogram for that segment will appear. Only the portion of the segment displayed and between the parameter cursors will be used in creating the histogram. The respective displayed trace field will show the number of events captured for the segment.



BLANK PAGE

Theory of Operation

An understanding of statistical variations in parameter values is needed for many waveform parameter measurements. Knowledge of the average, minimum, maximum, and standard deviation of the parameter may often be enough, but in many cases you may need a more detailed understanding of the distribution of a parameter's values.

Histograms allow you to see how a parameter's values are distributed over many measurements. They do this by dividing a range of parameter values into sub-ranges called *bins*. Maintained for each bin is a count of the number of parameter values — events — that fall within ranges of the bin itself.

While such a value range can be infinite, for practical purposes it need only be defined as large enough to include any realistically possible parameter value. For example, in measuring TTL high-voltage values a range of ± 50 V is unnecessarily large, whereas one of 4 V ± 2.5 V is more reasonable. It is the 5 V range that is then subdivided into bins. And if the number of bins used were 50, each would have a range of 5 V / 50 bins or 0.1 V/bin. Events falling into the first bin would then be between 1.5 V and 1.6 V. While the next bin would capture all events between 1.6 V and 1.7 V, and so on.

After a process of several thousand events, the bar graph of the count for each bin — its histogram — provides a good understanding of the distribution of values. Histograms generally use the 'x' axis to show a bin's sub-range value, and the 'y' axis for the count of parameter values within each bin. The leftmost bin with a non-zero count shows the lowest parameter value measurement(s). The vertically highest bin shows the greatest number of events falling within its sub-range.

The number of events in a bin, peak or a histogram is referred to as its *population*. Figure 4.1 on the next page shows a histogram's highest population bin as the one with a sub-range of 4.3 to 4.4 V (which is to be expected of a TTL signal).

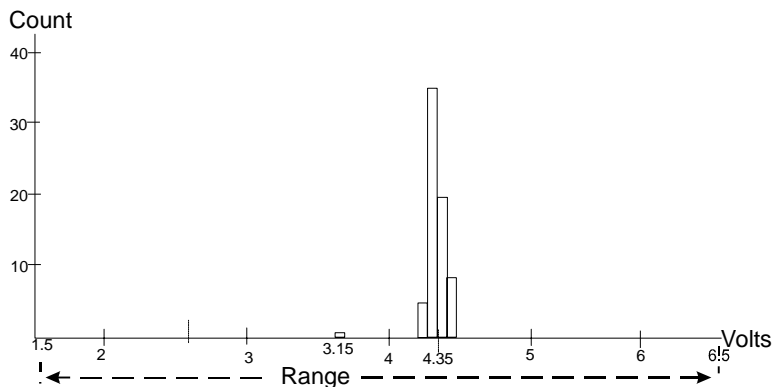

Figure 4.1

HISTOGRAMS

The lowest-value bin with events is that with a sub-range of 3.0 to 3.1 V. As TTL high voltages need to be greater than 2.5 V, the lowest bin is within the allowable tolerance. However, because of its proximity to this tolerance and the degree of the bin's separation from all other values, additional investigation may be required.

DSO PROCESS

The Waverunner digital storage oscilloscope (DSO) with WAVA generates histograms of the parameter values of input waveforms. But first, you must define the following:

1. The parameter to be histogrammed
2. The trace on which the histogram is to be displayed
3. The maximum number of parameter measurement values to be used in creating the histogram
4. The measurement range of the histogram
5. The number of bins to be used

Once these are defined, the oscilloscope is ready to make the histogram. The sequence for acquiring histogram data is as follows:

1. Trigger
2. Waveform acquisition
3. Parameter calculation(s)
4. Histogram update
5. Trigger re-arm.

If you set the timebase for non-segmented mode, a single acquisition occurs prior to parameter calculations. However, in Sequence mode an acquisition for each segment occurs prior to parameter calculations. If the source of histogram data is a memory, saving new data to memory effectively acts as a trigger and acquisition. Because updating the screen can take much processing time, it occurs only once a second, minimizing trigger dead time. Under remote control the display can be turned off to maximize measurement speed.

PARAMETER BUFFER

The oscilloscope maintains a circular parameter buffer of the last 20 000 measurements made, including values that fall outside the set histogram range. If the maximum number of events to be used for the histogram is a number 'N' less than 20 000, the histogram will be continuously updated with the last 'N' events as new acquisitions occur. If the maximum number is greater than 20 000, the histogram will be updated until the number of events is equal to 'N.' Then, if the number of bins or the histogram range is modified, the scope will use the parameter buffer values to redraw the histogram with either the last 'N' or 20 000 values acquired — whichever is the lesser. The parameter buffer thereby allows histograms to be redisplayed, using an acquired set of values and settings that produce a distribution shape with the most useful information.

In many cases the optimal range is not readily apparent. So the scope has a powerful range finding function. If required it will examine the values in the parameter buffer to calculate an optimal range and redisplay the histogram using it. Waverunner will also give a running count of the number of parameter values that fall within, below, or above the range. If any values fall below or above the range, the range finder can then recalculate to include these parameter values, as long as they are still within the buffer.

CAPTURE OF PARAMETER EVENTS

The number of events captured per waveform acquisition or display sweep depends on the parameter type. Acquisitions are initiated by the occurrence of a trigger event. Sweeps are equivalent to the waveform captured and displayed on an input channel (1, 2, or 3 or 4). For non-segmented waveforms an acquisition is identical to a sweep. Whereas for segmented waveforms an acquisition occurs for each segment and a sweep is equivalent to acquisitions for all segments. Only the section of a waveform between the parameter cursors is used in the calculation of parameter values and corresponding histogram events.

The following table provides a summary of the number of histogram events captured per acquisition or sweep for each parameter, and for a waveform section between the parameter cursors.

PARAMETERS (PLUS OTHERS, DEPENDING ON OPTIONS)	NUMBER OF EVENTS CAPTURED
data	All data values in the region analyzed.
duty, freq, period, width,	Up to 49 events per acquisition.
ampl, area, base, cmean, cmedian, crms, csdev, cycles, delay, dur; first, last, maximum, mean, median, minimum, nbph, nbpw, over+, over-, phase, pkpk, points, rms, sdev, Δdly, Δt@ lv	One event per acquisition.
f@ level, f80-20%, fall, r@ level, r20-80%, rise	Up to 49 events per acquisition.

HISTOGRAM PARAMETERS

Once a histogram is defined and generated, measurements can be performed on the histogram itself. Typical of these are the histogram's

- average value, standard deviation
- most common value (parameter value of highest count bin)
- leftmost bin position (representing the lowest measured waveform parameter value)
- rightmost bin (representing the highest measured waveform parameter value)

HISTOGRAMS

Histogram parameters are provided to enable these measurements. Available through selecting “Statistics” from the “Category” menu, they are calculated for the selected section between the parameter cursors (for a full description of each parameter, see Chapter 4):

avg	average of data values in histogram
fwhm	full width (of largest peak) at half the maximum bin
fwxx	full width (of largest peak) at xx% the maximum bin
hamp1	histogram amplitude between two largest peaks
hbase	histogram base or leftmost of two largest peaks
high	highest data value in histogram
hmedian	median data value of histogram
hrms	rms value of data in histogram
htop	histogram top or rightmost of two largest peaks
low	lowest data value in histogram
maxp	population of most populated bin in histogram
mode	data value of most populated bin in histogram
pctl	data value in histogram for which specified ‘x’% of population is smaller
pks	number of peaks in histogram
range	difference between highest and lowest data values
sigma	standard deviation of the data values in histogram
totp	total population in histogram
xapk	x-axis position of specified largest peak

ZOOM TRACES AND SEGMENTED WAVEFORMS

Histograms of zoom traces display all events for the displayed portion of a waveform between the parameter cursors. When dealing with segmented waveforms, and when a single segment is selected, the histogram will be recalculated for all events in the displayed portion of this segment between the parameter cursors. But if “All Segments” is selected, the histogram for all segments will be displayed.

HISTOGRAM PEAKS

Because the shape of histogram distributions is particularly interesting, additional parameter measurements are available for analyzing these distributions. They are generally centered around one of several peak value bins, known, with its associated bins, as a histogram peak.

Example: In Figure 4.2, a histogram of the voltage value of a five-volt amplitude square wave is centered around two peak value bins: 0 V and 5 V. The adjacent bins signify variation due to noise. The graph of the centered bins shows both as peaks.

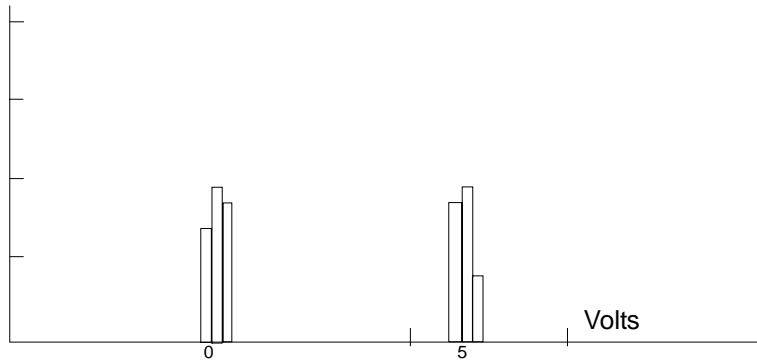

Figure 4.2

Determining such peaks is very useful because they indicate dominant values of a signal.

However, signal noise and the use of a high number of bins relative to the number of parameter values acquired, can give a jagged and spiky histogram, making meaningful peaks hard to distinguish. The scope analyzes histogram data to identify peaks from background noise and histogram definition artifacts such as small gaps, which are due to very narrow bins.

For a detailed description on how the scope determines peaks see the pks parameter description in Chapter 4.

BINNING AND MEASUREMENT ACCURACY

Histogram bins represent a sub-range of waveform parameter values, or events. The events represented by a bin may have a value anywhere within its sub-range. However, parameter measurements of the histogram itself, such as average, assume that all events in a bin have a single value. The scope uses the center value of each bin's sub-range in all its calculations. The greater the number of bins used to subdivide a histogram's range, the less the potential deviation between actual event values and those values assumed in histogram parameter calculations.

Nevertheless, using more bins may require that you perform a greater number of waveform parameter measurements, in order to populate the bins sufficiently for the identification of a characteristic histogram distribution.

In addition, very fine grained binning will result in gaps between populated bins that may make it difficult to determine peaks.

HISTOGRAMS

The oscilloscope's 20 000-parameter buffer is very effective for determining the optimal number of bins to be used. An optimal bin number is one where the change in parameter values is insignificant, and the histogram distribution does not have a jagged appearance. With this buffer, a histogram can be dynamically redisplayed as the number of bins is modified by the user. In addition, depending on the number of bins selected, the change in waveform parameter values can be seen.



avg

Average

Definition:

Average or mean value of data in a histogram.

Description:

The average is calculated by the formula: Avg =

$$\frac{\sum_{i=1}^n (\text{bin count})_i (\text{bin value})_i}{\sum_{i=1}^n (\text{bin count})_i} ,$$

where n is the number of bins in the histogram, bin count is the count or height of a bin, and bin value is the center value of the range of parameter values a bin can represent.

Example::

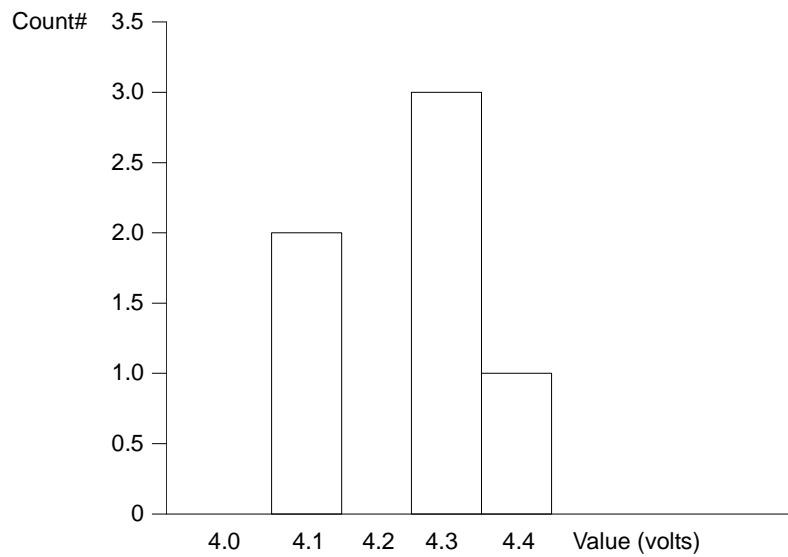

The average value of this histogram is: $(4.1 * 2 + 4.3 * 3 + 4.4 * 1) / 6 = 4.25$.

fwhm

Full Width at Half Maximum

Definition:

Determines the width of the largest area peak, measured between bins on either side of the highest bin in the peak that have a population of half the highest's population. If several peaks have an area equal to the maximum population, the leftmost peak is used in the computation.

Description:

First, the highest population peak is identified and the height of its highest bin (population) determined (for a discussion on how peaks are determined see the pks parameter Description:). Next, the populations of bins to the right and left are found, until a bin on each side is found to have a population of less than 50% of that of the highest bin's. A line is calculated on each side, from the center point of the first bin below the 50% population to that of the adjacent bin, towards the highest bin. The intersection points of these lines with the 50% height value is then determined. The length of a line connecting the intersection points is the value for **fwhm**.

Example:

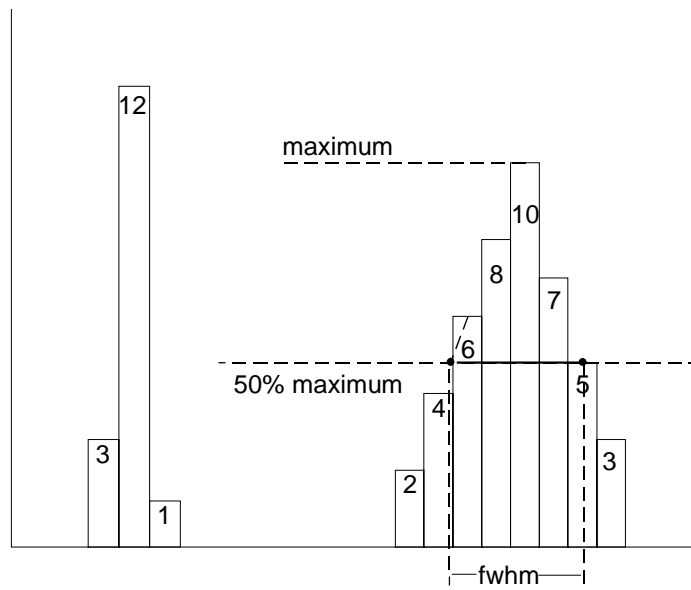

fwxx

Full Width at xx% Maximum

Definition:

Determines the width of the largest area peak, measured between bins on either side of the highest bin in the peak that have a population of xx% of the highest's population. If several peaks have an area equal to the maximum population, the leftmost peak is used in the computation.

Description:

First, the highest population peak is identified and the height of its highest bin (population) determined (see the pks Description:). Next, the bin populations to the right and left are found until a bin on each side is found to have a population of less than xx% of that of the highest bin. A line is calculated on each side, from the center point of the first bin below the 50% population to that of the adjacent bin, towards the highest bin. The intersection points of these lines with the xx% height value is then determined. The length of a line connecting the intersection points is the value for **fwxx**.

Parameter Settings:

Selection of the **fwxx** parameter in the "CHANGE PARAM" menu group causes the "MORE fwxx SETUP" menu to appear. Pressing the corresponding menu button displays a threshold setting menu that enables you to set the 'xx' value to between 0 and 100% of the peak.

Example:

fwxx with threshold set to 35%:

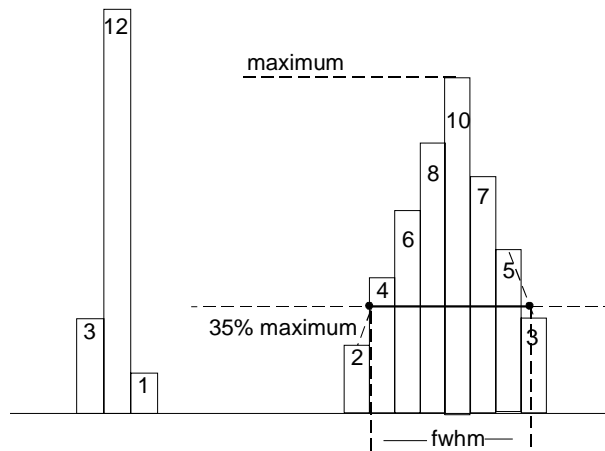

hampl

Histogram Amplitude

Definition: The difference in value of the two most populated peaks in a histogram. This parameter is useful for waveforms with two primary parameter values, such as TTL voltages, where **hampl** would indicate the difference between the binary '1' and '0' voltage values.

Description: The values at the center (line dividing the population of peak in half) of the two highest peaks are determined (see **pks** parameter description:). The value of the leftmost of the two peaks is the histogram base (see **hbase**). While that of the rightmost is the histogram top (see **htop**). The parameter is then calculated as:

$$\text{hampl} = \text{htop} - \text{hbase}$$

Example:

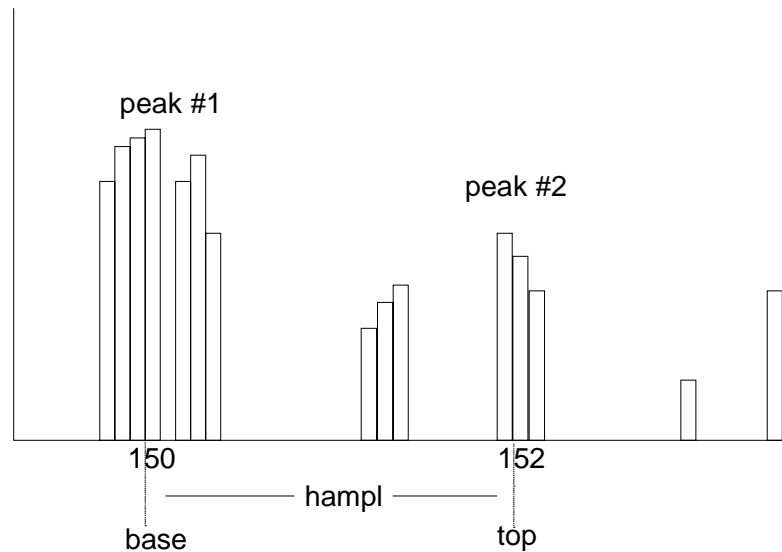

In this histogram, **hampl** is $152 \text{ mV} - 150 \text{ mV} = 2 \text{ mV}$.

Hbase

Histogram Base

Definition: The value of the leftmost of the two most populated peaks in a histogram. This parameter is primarily useful for waveforms with two primary parameter values such as TTL voltages where **hbase** would indicate the binary '0' voltage value.

Description: The two highest histogram peaks are determined. If several peaks are of equal height the leftmost peak among these is used (see **pks**). Then the leftmost of the two identified peaks is selected. This peak's center value (the line that divides the population of the peak in half) is the **hbase**.

Example:

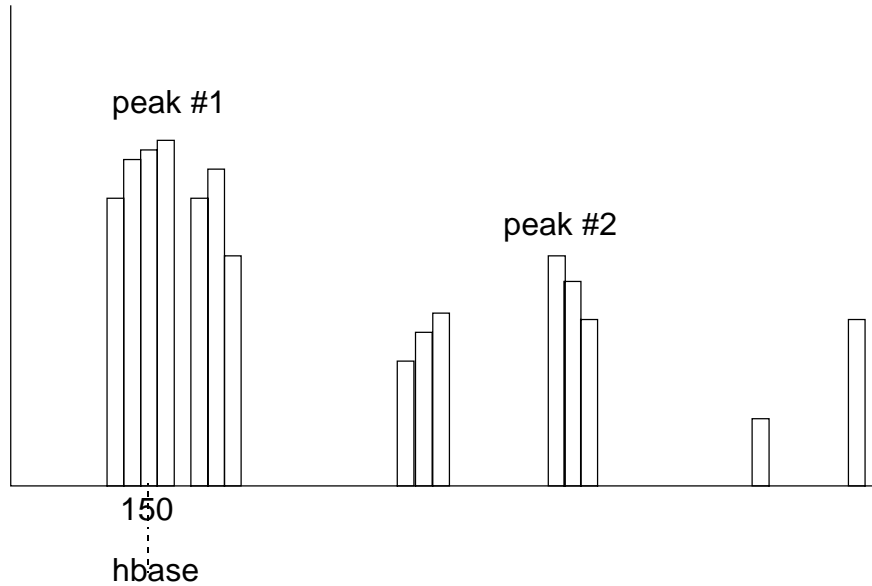

HISTOGRAMS

high

High

Definition: The value of the rightmost populated bin in a histogram.

Description: The rightmost of all populated histogram bins is determined: **high** is its center value, the highest parameter value shown in the histogram.

Example:

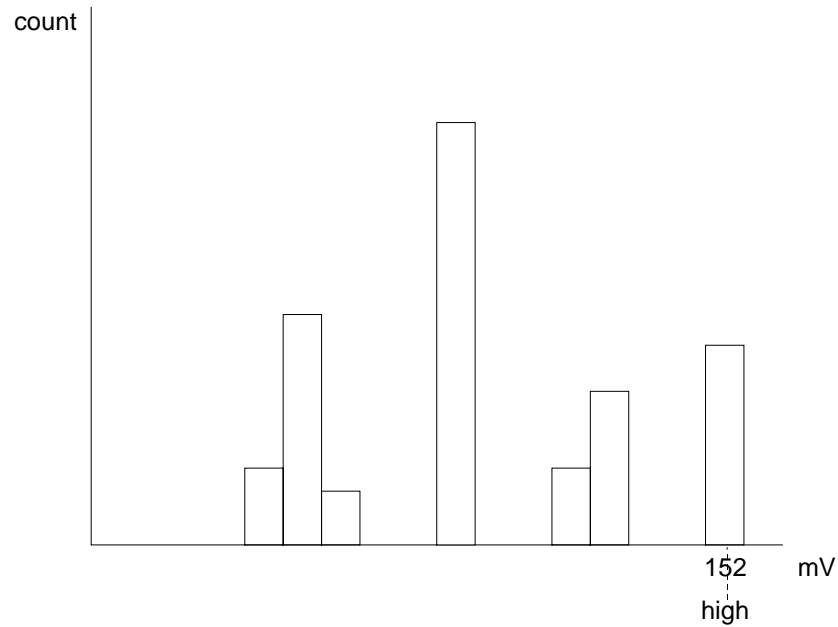

In this histogram **high** is 152 mV.

hmedian

Histogram Median

Definition: The value of the 'x' axis of a histogram, dividing the histogram population into two equal halves.

Description: The total population of the histogram is determined. Scanning from left to right, the population of each bin is summed until a bin that causes the sum to equal or exceed half the population value is encountered. The proportion of the population of the bin needed for a sum of half the total population is then determined. Using this proportion, the horizontal value of the bin at the same proportion of its range is found, and returned as **hmedian**.

Example: The total population of a histogram is 100 and the histogram range is divided into 20 bins. The population sum, from left to right, is 48 at the eighth bin. The population of the ninth bin is 8 and its sub-range is from 6.1 to 6.5 V. The ratio of counts needed for half- to total-bin population is:

$$2 \text{ counts needed} / 8 \text{ counts} = .25$$

The value for **hmedian** is:

$$6.1 \text{ volts} + .25 * (6.5 - 6.1) \text{ volts} = 6.2 \text{ volts}$$

hrms

Histogram Root Mean Square

Definition: The rms value of the values in a histogram.

Description: The center value of each populated bin is squared and multiplied by the population (height) of the bin. All results are summed and the total is divided by the population of all the bins. The square root of the result is returned as **hrms**.

Example: Using the histogram shown here, the value for **hrms** is:

$$\text{hrms} = \sqrt{(3.5^2 * 2 + 2.5^2 * 4)/6} = 2.87$$

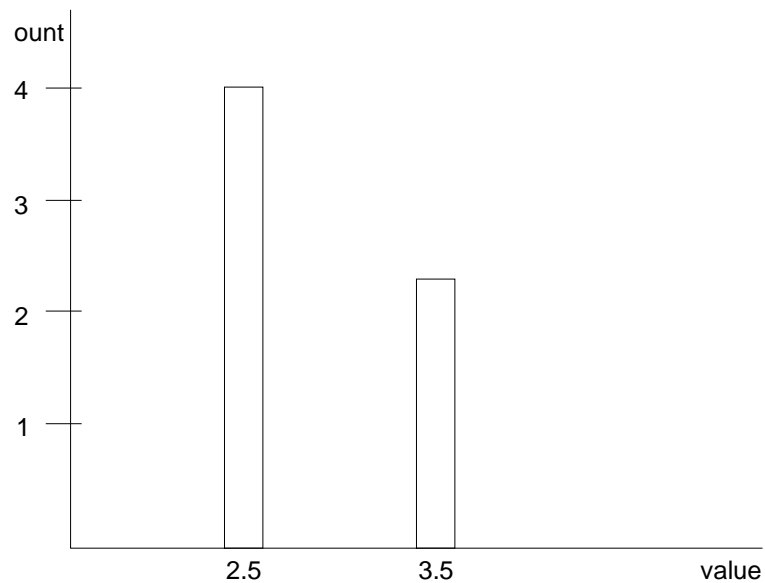

htop

Histogram Top

Definition: The value of the rightmost of the two most populated peaks in a histogram. This parameter is useful for waveforms with two primary parameter values, such as TTL voltages, where **htop** would indicate the binary '1' voltage value.

Description: The two highest histogram peaks are determined. The rightmost of the two identified peaks is then selected. The center of that peak is **htop** (center is the horizontal point where the population to the left is equal to the area to the right).

Example:

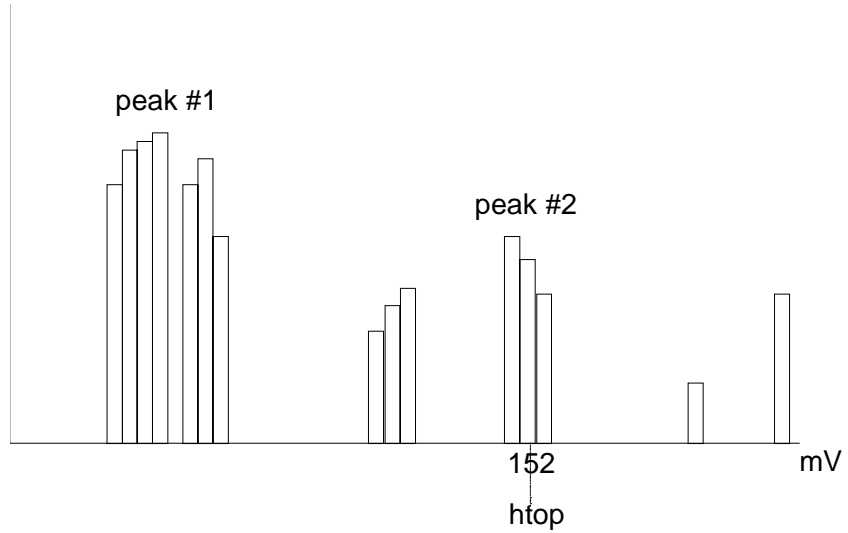

HISTOGRAMS

low

Low

Definition: The value of the leftmost populated bin in a histogram population. It indicates the lowest parameter value in a histogram's population.

Description: The leftmost of all populated histogram bins is determined. The center value of that bin is **low**.

Example:

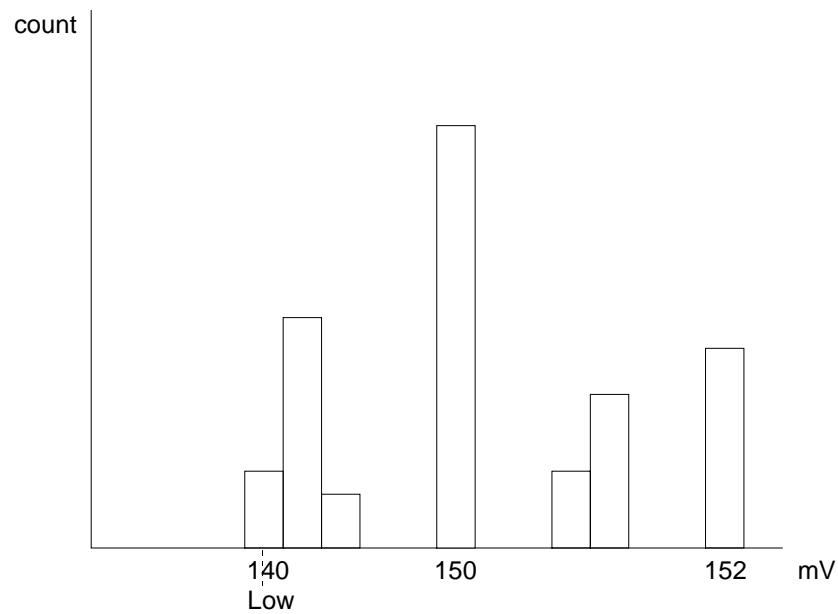

In this histogram **low** is 140 mV.

maxp

Maximum Population

Definition:

The count (vertical value) of the highest population bin in a histogram.

Description:

Each bin between the parameter cursors is examined for its count. The highest count is returned as **maxp**.

Example:

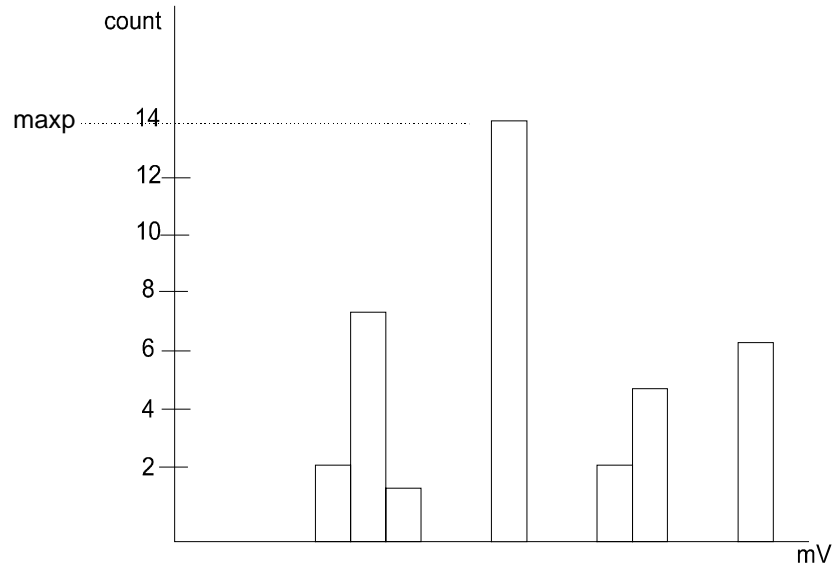

Here, **maxp** is 14.

mode

Mode

Definition: The value of the highest population bin in a histogram.

Description: Each bin between the parameter cursors is examined for its population count. The leftmost bin with the highest count found is selected. Its center value is returned as **mode**.

Example:

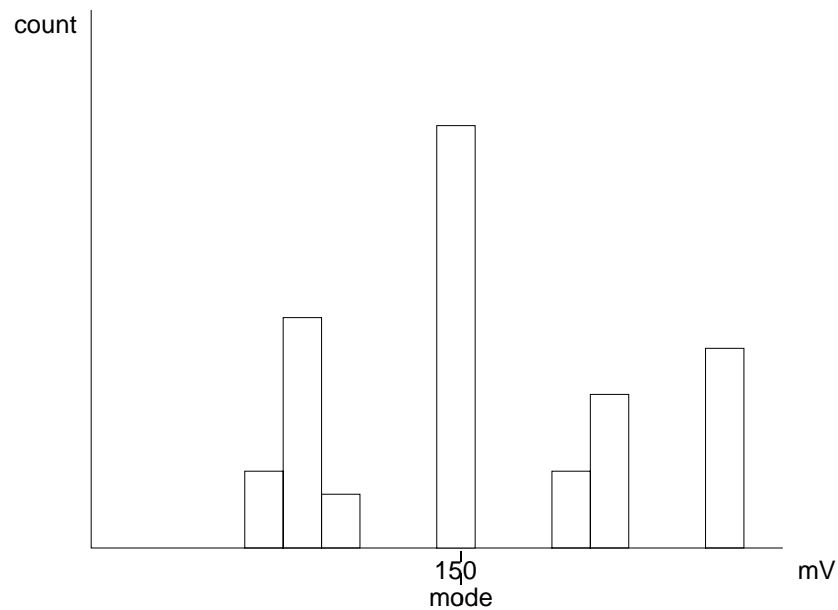

Here, **mode** is 150 mV.

pctl

Percentile

- Definition:** Computes the horizontal data value that separates the data in a histogram such that the population on the left is a specified percentage 'xx' of the total population. When the threshold is set to 50%, **pctl** is the same as **hmedian**.
- Description:** The total population of the histogram is determined. Scanning from left to right, the population of each bin is summed until a bin that causes the sum to equal or exceed 'xx'% of the population value is encountered. A ratio of the number of counts needed for 'xx'% population/total bin population is then determined for the bin. The horizontal value of the bin at that ratio point of its range is found, and returned as **pctl**.
- Example:** The total population of a histogram is 100. The histogram range is divided into 20 bins and 'xx' is set to 25%. The population sum at the sixth bin from the left is 22. The population of the seventh is 9 and its sub-range is 6.1 to 6.4 V. The ratio of counts needed for 25% population to total bin population is:

$$3 \text{ counts needed} / 9 \text{ counts} = 1/3.$$
 The value for **pctl** is:

$$6.1 \text{ volts} + .33 * (6.4 - 6.1) \text{ volts} = 6.2 \text{ volts}.$$
- Parameter Settings:** Selection of the **pctl** parameter in the "CHANGE PARAM" menu group causes the "MORE pctl SETUP" menu to appear. Pressing the corresponding menu button displays a threshold setting menu. With the associated knob you can set the percentage value to between 1% and 100% of the total population.

pks

Peaks

Definition: The number of peaks in a histogram.

Description: The instrument analyzes histogram data to identify peaks from background noise and histogram binning artifacts such as small gaps.

Peak identification is a 3-step process:

1. The mean height of the histogram is calculated for all populated bins. A threshold (T1) is calculated from this mean where:

$$T1 = \text{mean} + 2 \sqrt{\text{mean}}.$$

2. A second threshold is determined based on all populated bins under T1 in height, where:

$$T2 = \text{mean} + 2 * \text{sigma},$$

and where sigma is the standard deviation of all populated bins under T1.

3. Once T2 is defined, the histogram distribution is scanned from left to right. Any bin that crosses above T2 signifies the existence of a peak. Scanning continues to the right until one bin or more crosses below T2. However, if the bin(s) cross below T2 for less than a hundredth of the histogram range, they are ignored, and scanning continues in search of a peak(s) that crosses under T2 for more than a hundredth of the histogram range. Scanning goes on over the remainder of the range to identify additional peaks. Additional peaks within a fiftieth of the range of the populated part of a bin from a previous peak are ignored.

NOTE: If the number of bins is set too high a histogram may have many small gaps. This increases sigma and thereby T2, and in extreme cases can prevent determination of a peak, even if one appears to be present to the eye.

Example:

Here the two peaks have been identified. The peak with the highest population is peak # 1.

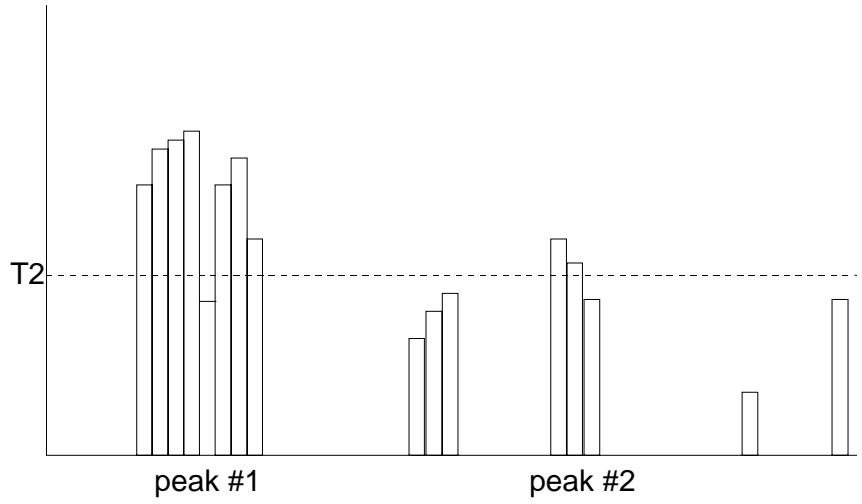

range

Range

Definition: Computes the difference between the value of the rightmost and that of the leftmost populated bin.

Description: The rightmost and leftmost populated bins are identified. The difference in value between the two is returned as the **range**.

Example:

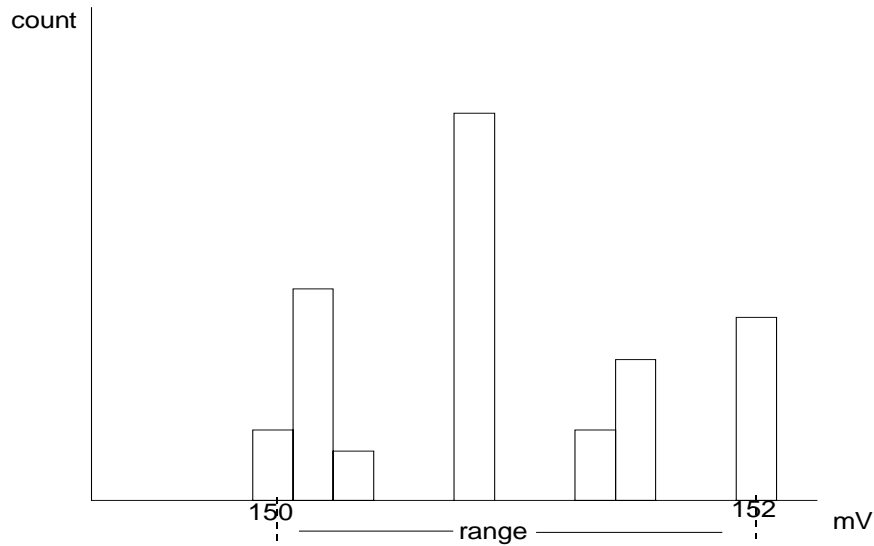

In this example: **range** is 2 mV

sigma

Sigma

Definition: The standard deviation of the data in a histogram.

Description: **sigma** is calculated by the formulas:

$$\text{mean} = \frac{\sum_{i=1}^n [\text{bin count}_i * \text{bin value}_i]}{(\sum_{i=1}^n \text{bin count}_i)};$$

$$\text{sigma} = \sqrt{\frac{\sum_{i=1}^n [\text{bin count}_i * (\text{bin value}_i - \text{mean})^2]}{(\sum_{i=1}^n [\text{bin count}_i] - 1)}};$$

where n is the number of bins in the histogram, bin count is the count or height of a bin, and bin value is the center value of the range of parameter values a bin can represent.

Example: For the histogram:

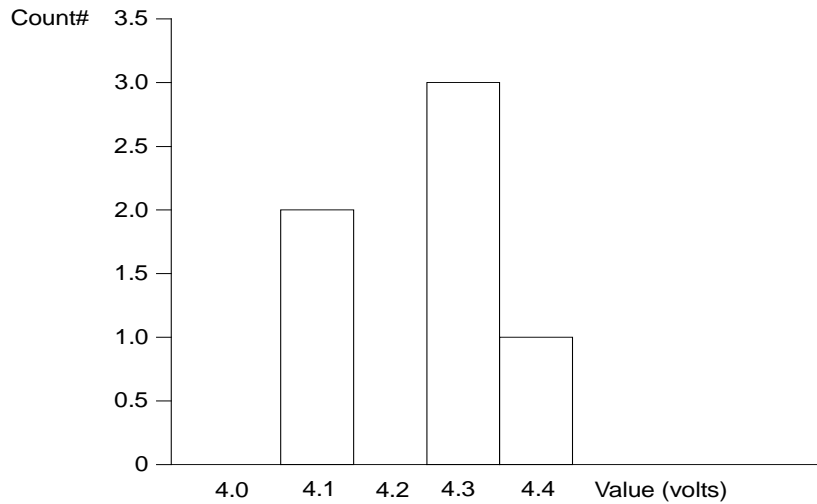

$$\text{mean} = (2 * 4.1 + 3 * 4.3 + 1 * 4.4) / 6 = 4.25$$

$$\text{sigma} = \sqrt{(2 * (4.1 - 4.25)^2 + 3 * (4.3 - 4.25)^2 + 1 * (4.4 - 4.25)^2) / (6 - 1)} = 0.1225$$

totp

Total Population

Definition: Calculates the total population of a histogram between the parameter cursors.

Description: The count for all populated bins between the parameter cursors is summed.

Example:

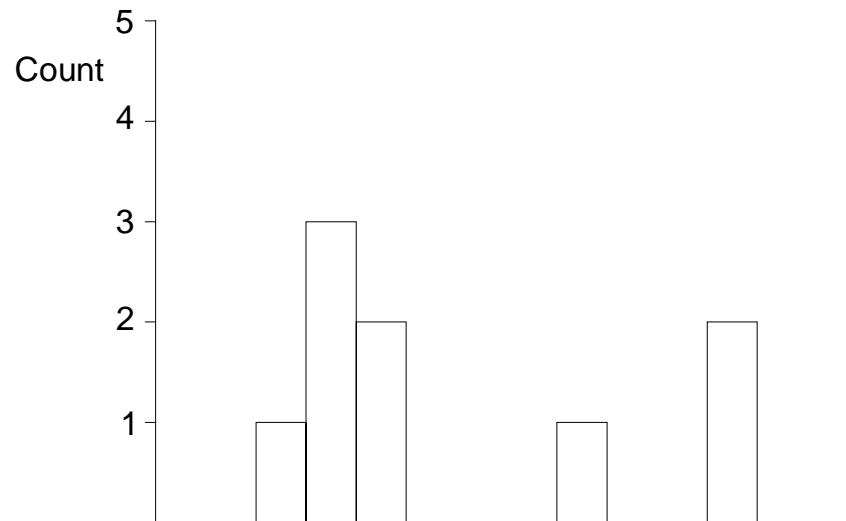

The total population of this histogram is 9.

xapk

X Coordinate of xx'th Peak

Definition:

Returns the value of the xx'th peak that is the largest by area in a histogram.

Description:

First the peaks in a histogram are determined and ranked in order of total area (for a discussion on how peaks are identified see the Description: for the **pks** parameter). The center of the n'th ranked peak (the point where the area to the left is equal to the area to the right), where n is selected by you, is then returned as **xapk**.

Example:

The rightmost peak is the largest, and is thus ranked first in area (1). The leftmost peak, although higher, is ranked second in area (2). The lowest peak is also the smallest in area (3).

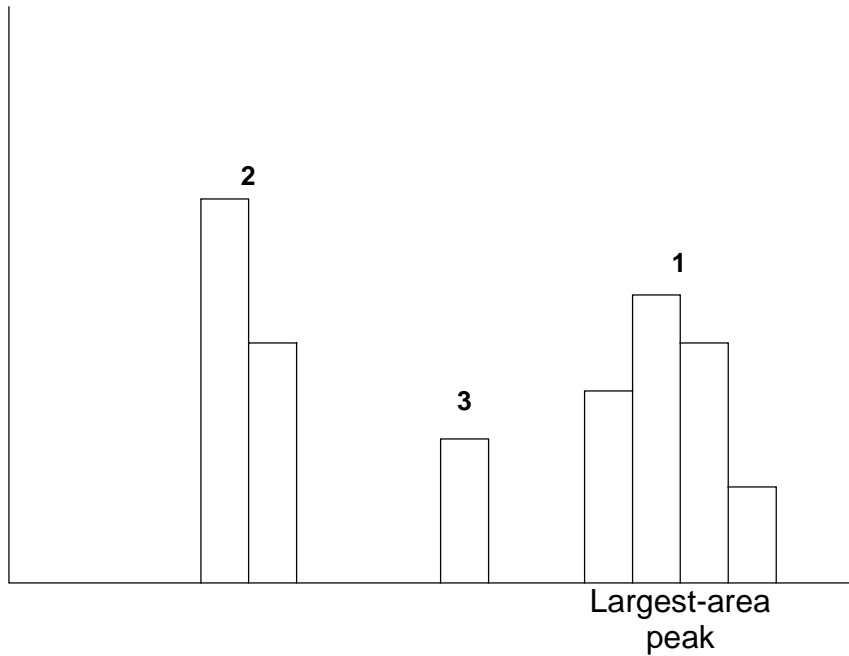

BLANK PAGE



Instrument Architecture Overview

PROCESSORS

The Waverunner central processing unit (CPU), a PowerPC™ microprocessor, performs the oscilloscope's computations, and controls its operation. A range of peripheral interfaces allow you to control remotely, store waveforms and other data, and make hard copies. A support processor constantly monitors the front panel controls. The Waverunner transfers data to display memory for direct waveform display, or stores it to reference memories for fast data processing.

ADCs

Each Waverunner channel has an 8-bit Analog-to-Digital Converter (ADC). The instrument's ADC architecture is designed to give excellent amplitude and phase correlation, maximum analog-to-digital conversion performance, large record lengths, and superior time resolution.

MEMORIES

Waverunner acquisition memories simplify signal acquisition by producing waveform records that allow detailed analysis over large time intervals. There are four memories for temporary storage, and four more for waveform zooming and processing.

RIS

The Waverunner oscilloscope captures and stores repetitive signals at a maximum Random Interleaved Sampling (RIS) rate of 25 GS/s. This advanced digitizing technique enables measurement of repetitive signals with an effective sampling interval of 100 ps, and a measurement resolution of up to 10 ps.

TRIGGER SYSTEM

You can control Waverunner triggering to a highly specialized degree in accordance with waveform characteristics and chosen trigger conditions. The trigger source can be any of the input channels, line (synchronized to scope's main input supply) or external. The coupling is selected from AC, LF REJECT, HF REJECT, HF, and DC; the slope from positive and negative. Waverunner SMART Trigger offers a wide range of sophisticated trigger modes matched to special trigger conditions and sets of conditions.

AUTOMATIC CALIBRATION

The Waverunner's automatic calibration ensures an overall vertical accuracy of typically 1% of full scale. Vertical gain and offset calibration, and horizontal (time) resolution take place each time you change the volts per division setting. Periodic and temperature dependent auto-calibration ensures long-term stability at the current setting.

DISPLAY SYSTEM

You control the display's interactive, user-friendly interface using push buttons and knobs. Display as many as eight different waveforms at once on eight separate grids. The parameters controlling signal capture are simultaneously reported. The Waverunner displays internal status and measurement results, as well as operational, measurement, and waveform analysis menus.

The 8.4-inch color flat panel TFT LCD screen displays waveforms and data by means of advanced color management. Overlap mixing and contrast enhancement functions ensure that overlapping waveforms remain distinct at all times. Preset and personal color schemes are available.

The Analog Persistence function offers display attributes of an analog instrument with all the advantages of digital technology. The Full Screen function expands waveform grids to fill the entire screen.

A hard copy of the screen can be easily produced by pressing the front panel PRINT SCREEN button.

INTERFACE AND PANEL SETUPS

Although the Waverunner is a truly digital instrument, the front panel layout and controls are similar to those of an analog oscilloscope. Rapid response and instant representation of waveforms on the high resolution screen add to this similarity. Four front panel setups can be stored internally, and recalled directly or by remote control, thus ensuring rapid front panel configuration. When power is switched off, the front panel settings are automatically stored for recall when the scope is next powered on.

REMOTE CONTROL

The Waverunner has also been designed for remote control operation in automated testing and computer aided measurement applications. You control the entire measurement process — cursor and pulse-parameter settings, dynamic modification of front panel settings, and display organization — through the rear panel industry standard GPIB (IEEE-488) and standard RS-232-C ports. See Chapter 12, "Use Waverunner with PC," of this manual and the *Remote Control Manual*.

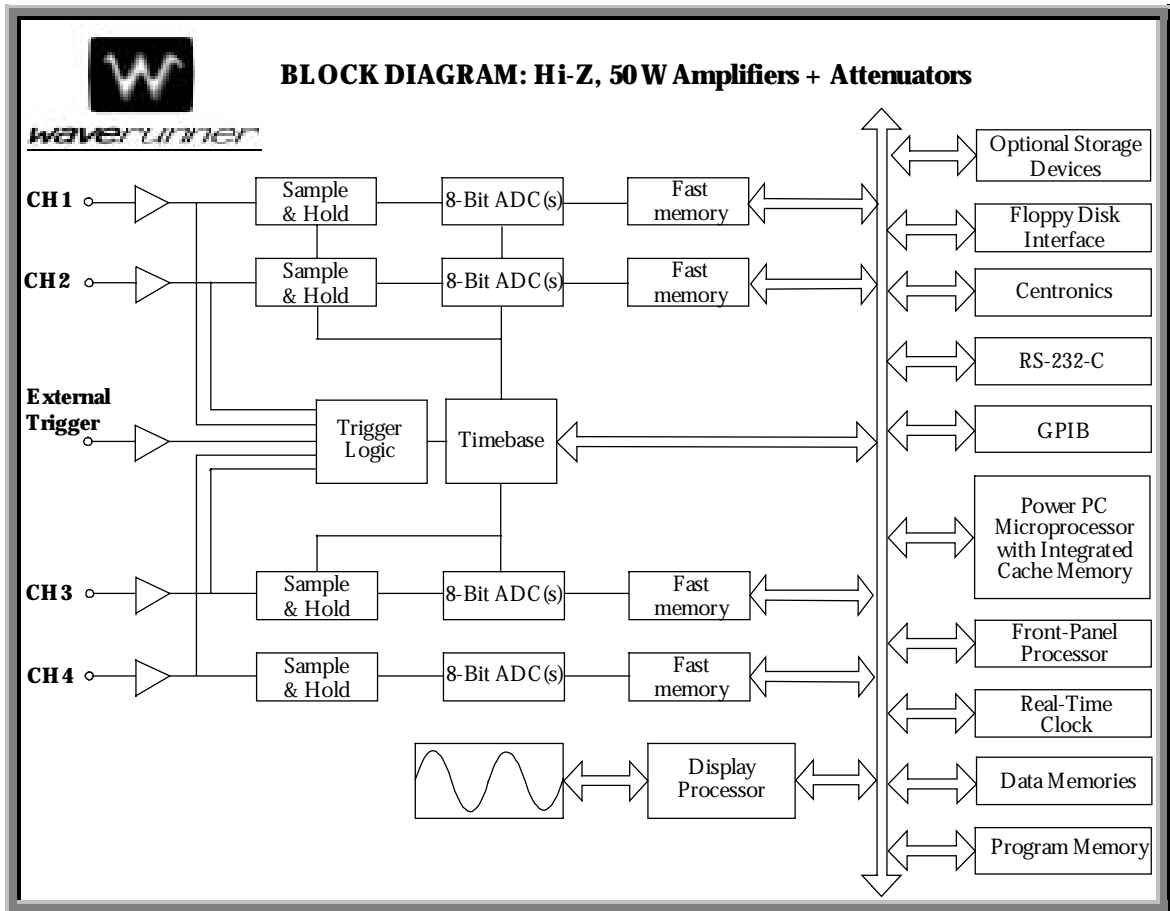

LT22X, LT32X, and LT34X models

Specifications

MODELS

Waverunner LT 342/ LT 322 Series: Two channels

Waverunner LT 344/ LT 244/ LT 364 Series: Four channels

NOTE: Specifications are subject to change without notice. For the most up-to-date information, consult the latest data sheets, available from LeCroy offices.



ACQUISITION SYSTEM

Bandwidth (–3dB): LT 342/ LT 344/ LT 322/ LT 364: 500 MHz; **LT 224:** 200 MHz. Bandwidth @ 50 Ω and at probe tip with PP006. Bandwidth Limiter at 25 MHz (LT224), and 25 MHz or 200 MHz (other models) can be selected for each channel.

Input Impedance: 50 Ω ±1.0%; 1 MΩ ±1.0% // 12 pF typical (using PP006 probe)

Input Coupling: 1 MΩ: AC, DC, GND; 50 Ω: DC, GND



Max Input: 50 Ω: 5 V rms; 1 MΩ: 400 V max (peak AC ≤ 5 kHz + DC)

Single Shot Sampling Rate: LT 342/ LT 344/ LT 364: 500 MS/s; **LT 224/ LT 322:** 200 MS/s

Acquisition Memory (4 channel): LT 342L/ LT 344/ LT 364L: 1 M; **LT 342/ LT 344/ LT 364:** 250k points per channel; **LT 224/ LT 322:** 100k points per channel; 1 M points per channel on L models

Acquisition Memory (2 channel): LT 364: 500k; **LT 364L:** 2 M

Vertical Resolution: 8 bits

Sensitivity: 2 mV to 5 V/ div fully variable; 10 V/ div

DC Accuracy: ±1.5% (0.5% of full scale)

Offset Range:

2 mV to 50 mV/ div: ±1 V

100 mV to 500 mV/ div: ±10 V

1 V to 10 V/ div: ±100 V

Interleaved Channels: LT 364 Series: 2

ACQUISITION MODES			
MODE	TIMEBASE SETTING	MAXIMUM RATE	DESCRIPTION
Single Shot	5 ns to 1000 s/ div (LT364)	1 GS/s (LT364)	One ADC per channel
	10 ns to 1000 s/ div (LT342/LT344)	500 MS/s	
	20 ns to 1000 s/ div (LT224/LT322)	200 MS/s (LT224)	
Repetitive	1 ns to 5 μ sec/ div (LT342/LT344/LT364)	25 GS/s	Random Interleaved Sampling (RIS)
	5 ns to 5 μ sec/ div (LT224/LT322)	10 GS/s	
Sequence			
LT 342/ LT 344/ LT 364	2–1000 segments	500 MS/s	Stores Multiple Events with time stamp in segmented acquisition memories
LT 224/ LT 322	2–400 segments	500 MS/s 200 MS/s (LT224)	Stores Multiple Events with time stamp in segmented acquisition memories
LT 342L / LT 344L / LT 364L	2–4000 segments	500 MS/s	Stores Multiple Events with time stamp in segmented acquisition memories
Roll	≤ 500 kpts: 500 ms to 1000s/ div	100 kS/s	Waveform slowly rolls across display when used with slow time bases.
	≥ 500 kpts: 1 s to 1000 s/ div		

TIMEBASE SYSTEM

Timebases: Main and up to four zoom traces simultaneously

Time/ Div Range: 1 ns/ div to 1000 s/ div

Clock Accuracy: ≤ 10 ppm

Interpolator Resolution: 5 ps

External Clock: **LT 342/ LT 344/ LT 322:** ≤ 500 MHz; **LT 224:** ≤ 200 MHz; 50 Ω , or 1 M Ω impedance

TRIGGERING SYSTEM

Modes: NORMAL, AUTO, SINGLE and STOP

Sources: Any input channel, External, EXT 10 or line; slope, level, coupling unique to each except line.

Coupling Modes: DC, AC, HF, HFREJ, LFREJ (reject frequency 50 kHz typical)

Pre-Trigger Recording: 0–100% of horizontal time scale

Post Trigger Delay: 0–10 000 divisions

Holdoff by Time or Events: Up to 20 s or from 1 to 99 999 999 events

Internal Trigger Range: ± 5 div

Maximum Trigger Frequency: Up to 500 MHz with HF coupling



External Trigger Input: ± 0.5 V, ± 5 V with Ext 10; max input same as input channels

SMART TRIGGER TYPES (ALL MODELS)

Signal or pulse width: Triggers on glitches down to 2 ns. Pulse widths are selectable between < 2.5 ns to 20 s.

Signal interval: Triggers on intervals selectable between 10 ns and 20 s.

TV: Triggers on line (up to 1500) and field 1 or 2 (odd or even) for PAL (SECAM), NTSC, or non-standard video (**LT 364 Series:** a choice of 1, 2, 4, or 8 fields is offered).

State/ Edge qualified: Triggers on any input source only if a given state (or transition) has occurred on another source. Delay between sources is selectable by time or number of events.

Dropout: Triggers if the input signal drops out for longer than a selected time-out between 25 ns and 20 s.

Window: Triggers when the signal crosses the window boundaries, which extend above and below the selected trigger level. A trigger event will occur when the signal leaves this window region in either direction and passes into the upper or lower region. The next trigger will occur when the signal again passes into the window region.

SMART TRIGGER TYPES (LT 364 SERIES ONLY)

Pattern (5 inputs): Enables triggering on a logical combination of the five inputs CH 1, CH 2, CH 3, CH 4 and EXT. This combination, called a pattern, is defined as the logical AND of trigger states.

AUTOSETUP

Automatically sets timebase, trigger, and sensitivity to display a wide range of repetitive signals.

Vertical Find: Automatically sets sensitivity for the selected input signal

PROBES

Model PP006: PP006 with auto-detect: 10:1, 10 M Ω ; one probe per channel

Probe System: ProBus Intelligent Probe System supports active, high voltage, current, and differential probes, and differential amplifiers

COLOR WAVEFORM DISPLAY

Type: Color 8.4-inch flat panel TFT LCD with VGA, 640 x 480 resolution

Screen Saver: Display blanks after 10 minutes

Real Time Clock: Date, hours, minutes, and seconds displayed with waveform

Number of Traces: Maximum eight on LT344, LT224 Series, six on LT342, LT322 Series; simultaneously display channel, zoom, memory, and math traces

Grid Styles: Single, Dual, Quad, Octal, XY, Single+XY, Dual+XY; Full Screen gives enlarged view of each style

Waveform Display Styles: Sample dots joined or dots only — regular or bold

ANALOG PERSISTENCE DISPLAY

Analog Persistence and Color Graded Persistence: Variable saturation levels; stores each trace's persistence data in memory

Trace Display: Opaque or transparent overlap

ZOOM EXPANSION TRACES

Style: Display up to four zoom traces

Vertical Zoom: Up to 5x expansion, 50x with averaging

Horizontal Zoom: Expand to 2 pts/div, magnify to 50 000x

Autoscroll: Automatically scan and display a captured signal

RAPID SIGNAL PROCESSING

Processor: 96 MHz Power PC

LT 342/ LT 322	LT 364/ LT 344/ LT 224	LT 342L	LT 364/ LT 344L
16 MBYTES	16 MBYTES	32 MBYTES	32 MBYTES
64 MBYTE SYSTEM MEMORY OPTIONAL FOR ALL MODELS			

INTERNAL WAVEFORM MEMORY

Waveform: M1, M2, M3, M4; memory length equal to acquisition memory

Zoom and Math: A, B, C, D; memory length equal to acquisition memory

Memories M1-4 and A-D store full-length waveforms with 16 bits/ data point

SETUP STORAGE

For front panel and instrument status: Four non-volatile memories and floppy drive are standard; hard drive and memory card are optional

MATH TOOLS

Simultaneously perform up to four math processing functions; traces can be chained together to perform math on math. Standard functions: add, subtract, multiply, divide, negate, identity, summation, averaging to 1000 sweeps, ERES low-pass digital filters for 11-bit vertical resolution, FFT of 50 kpoint waveforms, Extrema for displaying envelope roof and floor, physical units, rescale (with units), sin x/ x, resample (deskew).

MEASURE TOOLS

Cursor Measurements:

Relative Time: Two arrow cursors measure time and voltage differences relative to each other with a resolution of $\pm 0.05\%$ full scale.

Relative Amplitude (Voltage): Two horizontal bars measure voltage differences at $\pm 0.2\%$ fs resolution.

Absolute Time: Cross-hair marker measures time relative to trigger and voltage with respect to ground.

Absolute Amplitude (Voltage): A horizontal reference line cursor measures voltage with respect to ground.

Automated Measurements: Display any five parameters together with their average, high, low and standard deviations.

Pass/Fail: Test any five parameters against selectable thresholds. Limit testing is performed using masks created on the scope or on a PC. Setup a pass or fail condition to initiate actions such as hardcopy output, save waveform to memory, GPIB SRQ, or pulse out.

EXTENDED MATH AND MEASUREMENTS OPTION

Adds math and advanced measurements for general purpose applications. Math Tools is expanded to include all standard math plus integration, derivative, log and exponential (base e and base 10), square, square root, absolute value, plus data log when using the trend function.

WAVEANALYZER OPTION

Adds math processing to include FFTs of 1 Mpoint waveforms, power spectrum density, spectrum averaging, waveform averaging to one million sweeps, continuous averaging, waveform histograms, and histogram parameters. Includes the Extended Math and Measurement option.

SPECIAL APPLICATION SOLUTIONS

Jitter and Timing Analysis (JTA): Precision cycle-to-cycle timing measurements with enhanced accuracy, histograms on persistence traces, persistence to waveform tracing and full statistical analysis.

PowerMeasure™: A complete solution for the power conversion engineer. Includes timing deskew of voltage and current, and rescale to electrical units.

INTERFACE

Remote Control: Full control via GPIB and RS-232-C*

Floppy Drive: Internal, DOS format, 3.5" high density

PC Card Slot: Supports memory and hard drive cards

External Monitor Port: 15-pin D-Type VGA compatible*

Centronics Port: Parallel printer interface*

Internal graphics printer (optional): 25 mm/s max, 112 mm paper width; provides hardcopy output in < 10 seconds

Ethernet (optional): 10BASE-T



* Shielded cables of less than 3 m length are required to conform with EMC Directive 89/336/EEC.

OUTPUTS

Calibrator signal: 500 Hz–1 MHz square wave, –1.0 to +1.0, test point, and ground lug on front panel

Control signals: Choice of trigger ready, trigger out, or Pass/Fail status; TTL levels into 1 M Ω at rear panel BNC (output resistance 300 Ω \pm 10%)



GENERAL

Operating Conditions: Temperature 5–40° C; Humidity 80% RH max (non-condensing) at 40° C; Altitude \leq 2000 m

Shock and Vibration: Conforms to selected sections of MIL-PRF-28800F, Class 3

Power Requirements: 90–132 V AC and 180–250 V AC; 45–66 Hz; automatic AC voltage selection; Power dissipation: 230 VA max

Dimensions (HWD): 210 mm x 350 mm x 300 mm (8.3" x 13.8" x 11.8"); height excludes scope feet

Weight: 8 kg (18 lbs)

Warranty and Calibration: Three years; calibration recommended yearly

Certifications: CE, UL and cUL

CE Declaration of Conformity: The oscilloscope meets requirements of the EMC Directive 89/336/EEC for Electromagnetic Compatibility and Low Voltage Directive 73/23/EEC for Product Safety.

EMC Directive

EN61326-1: 1997

EMC requirements for electrical equipment for measurement, control, and laboratory use.

Electromagnetic Emissions:	EN55011: 1991, Class A	Radiated and conducted emissions
	EN61000-3-2: 1995	Harmonic Current Emissions
	EN61000-3-3: 1995	Voltage Fluctuations and Flickers

Warning: This is a Class A product. In a domestic environment this product may cause radio interference, in which case the user may be required to take adequate measures.

Electromagnetic Immunity:	ENV 50204: 1995	900 MHz Keyed Carrier RF Field
	EN 61000-4-2: 1995	Electrostatic Discharge
	EN 61000-4-3: 1996*	RF Radiated Electromagnetic Field
	EN 61000-4-4: 1995*	Electrical Fast Transient/ Burst
	EN 61000-4-5: 1995*	Surges
	EN 61000-4-6: 1996*	RF Conducted Electromagnetic Field
	EN 61000-4-8: 1994	Power Frequency Magnetic Field
	EN 61000-4-11: 1994**	Mains Dips and Interruptions

* Meets Performance Criteria “B” limits — at certain test levels, during the disturbance, product undergoes a temporary degradation or loss of function of performance which is self recoverable.

** Meets Performance Criteria “C” limits — at certain test levels, during the disturbance, product undergoes a temporary degradation or loss of function of performance which requires operator intervention or system reset.

Low Voltage Directive:	EN61010-1: 1993 + Amd.2: 1995
	Safety requirements for electrical equipment for measurement, control, and laboratory use.
	The oscilloscope has been qualified to the following EN61010-1 category: Installation (Overvoltage) Category II.
	Pollution Degree 2

UL and cUL Certifications:	UL Standard: UL 3111-1
	Canadian Standard: CSA-C22.2 No. 1010.1-92



BLANK PAGE



Acquisition Time: In a sample-and-hold or track-and-hold circuit, the time required after the sample or track command for the output to slew through a full-scale voltage change and settle to its final value within a specified error band.

ACSN: auto-correlation signal-to-noise

ADC: analog-to-digital converter.

Aliasing: Whenever a dynamic signal is synchronously sampled, a possibility of misunderstanding its frequency content exists. This difficulty is termed “aliasing” and occurs whenever the sampling rate is less than twice the highest frequency component in the signal being measured.

AND: Logical designation or circuit function meaning that all inputs must be in the TRUE state for a TRUE output.

Aperture Jitter: In a sample-and-hold or ADC, the jitter between the time of the sample (or convert) command pulse and the time the input signal is actually sampled. This jitter is usually due to thermal noise. It leads to an uncertainty in the sampled amplitude equal to $\Delta t \cdot dV/dt$, where Δt is the aperture jitter, and dV/dt is the rate of change of the input voltage at the time of sampling. The terms “aperture jitter” and “aperture uncertainty” are often used interchangeably.

Aperture Uncertainty: In a sample-and-hold or ADC, the total uncertainty in the time of the sample (or convert) command pulse and the time the input signal is actually sampled, due to all causes including noise, signal amplitude-dependent delay variation (as in a flash ADC), temperature, etc. Often used interchangeably with “aperture jitter,” but “aperture uncertainty” is the more inclusive term.

Area: In a time domain DSO waveform measurement, area is the sum of the sampled values between the cursors times the duration of a sample.

Artifact Rejection: Used in summed averaging to exclude waveforms that have exceeded the dynamic range of the recording system.

Automatic Setup: In an oscilloscope, automatic scaling of the timebase, trigger, and sensitivity settings. Provides a stable display of repetitive input signals.

Average: See Mean Value, Summed Averaging and Continuous Averaging

AWG: arbitrary wave generator

Bandwidth: In normal use, the frequency range over which the gain of an amplifier or other circuit does not vary by more than 3 dB.

BER: See Bit Error Rate.

Binning: A technique for combining points in a histogram to be compatible with the resolution of the display device.

Bit: An abbreviation of “binary digit,” one of the two numbers, 0 and 1, used to encode data. A bit is often expressed by a high or low electrical voltage.

Bit Error Rate: Ratio of the number of bits of a message incorrectly received to the total number received.

CCD: Charge Coupled Device. An integrated circuit that allows the transfer of a variable amount of charge through a series of cells; an analog shift register.

CCTM: clock certification test module

Channel: A path through an arrangement of components (modules and electrical or optical cabling or both) along which signals can be sent.

Clamping: Holding a circuit point to some reference level (frequently ground) by means of a low-impedance element such as a saturated transistor, FET, forward-biased diode, relay, etc.

Coherent Gain: The normalized coherent gain of a filter corresponding to each window function is 1.0 (0 dB) for the rectangular window and less than 1.0 for other windows. It defines the loss of signal energy due to the multiplication by the window function.

Common Mode Range: The maximum range (usually voltage) within which differential inputs can operate without a loss of accuracy.

Common Mode Rejection Ratio: The ratio of the common-mode input voltage to the output voltage expressed in dB. The extent to which a differential amplifier does not provide an output voltage when the same signal is applied to both inputs.

Common Mode Signal (Noise): The signal (usually noise) that appears equally and in phase on each of the differential signal conductors to ground. See Differential Input.

Continuous Averaging: Sometimes called “exponential averaging,” the technique consists of the repeated addition, with unequal weight, of successive source waveforms. Each new waveform is added to the accumulated average according to the formula: $S(i, \text{new}) = N / (N + 1) * [S(i, \text{old}) + 1 / (N + 1) * W(i)]$ where i = index over all data points of the waveforms; $W(i)$ = newly acquired wave form; $S(i, \text{old})$ = old accumulated average; $S(i, \text{new})$ = new accumulated average; N = weighting factor (1,3,7...).

Conversion Cycle: Entire sequence involved in changing data from one form to another, e.g., digitizing an analog quantity, changing binary data to BCD, etc.

Crosstalk: Unwanted coupling of a signal from one channel to another.

Cursor: A visible marker that identifies a horizontal or vertical position, or both, on an oscilloscope display. LeCroy DSOs offer “waveform riding” cursors that conveniently give both the horizontal and vertical values without selecting one or the other.

DAC: digital-to-analog converter

Data Logger: An instrument that accepts input signals (usually slow analog), digitizes them, and stores the results in memory for later readout. The digital equivalent of a strip-chart recorder.

DC: Direct current. Normally means a voltage or current that remains constant.

DC Level Shift: A change in the nominal DC voltage level present in a circuit.

DC Offset: See DC Level Shift. This term may imply that the shift is intentional, for example, adjustable by a control knob.

DC Overload: An overload signal of long duration compared to the normal input pulse width or duty ratio of a circuit.

Dead Time: In a digital oscilloscope, the dead time is the time from the end of one acquisition of data to the start of the next acquisition.

Decimation: The process of reconstructing a source waveform with a reduced number of data points by using only every n th data point, where n is an integer.

Differential Input: A circuit with two inputs that is sensitive to the algebraic difference between the two.

Differential Linearity: A term often inappropriately used to mean differential non-linearity.

Differential Non-Linearity: **1.** The percentage departure from the average of the slope of the plot of output versus input from the slope of a reference line; **2.** The percentage of variation in ADCs or TDCs from the mean of the analog (or time) width of any single digital step. It is usually measured by driving the input with a large number of random amplitude pulses and then measuring the relative number of events in each digital bin.

Differential Output: A circuit with two outputs supplying one normal and one complementary level of output signal.

Differential Pulses: Two opposite polarity pulses coincident in time.

Dithering: Typically used when averaging signals (which have low noise content) to improve vertical resolution and decrease the effects of an ADC's non-linearities. The technique applies different offsets to each incoming waveform to ensure the signal is not always digitized by the same portion of the ADC. The offsets must be subtracted from the recorded signals before being included in the summed average.

Digital Filtering: The manipulation of digital data to both enhance desirable and to remove undesirable aspects of the data.

Dropout Trigger: A trigger that occurs if the input signal drops out for a time period longer than a preset amount (between 25 ns to 20 s on some LeCroy DSOs). This is very useful for triggering on microprocessor crashes, network hangups, bus contention problems or other phenomena where a signal stops occurring.

Duty Cycle: A computed value in digital scopes representing the average duration above midpoint value as a percentage of the period for time domain waveforms.

Dynamic Range: The ratio of the largest to smallest signal that can be accurately processed by a module.

Dynamic RAM (DRAM): A random access memory in which the internal memory must be refreshed periodically.

ECL: Emitter-coupled logic, an unsaturated logic performed by emitter-coupled transistors. Usually, ECL LOGICAL 1 = -1.6 V and LOGICAL 0 = -0.8 V.

EMI: Electromagnetic interference caused by current or voltage induced into a signal conductor by an electromagnetic field.

ENBW (Equivalent Noise Bandwidth): For a filter associated with each frequency bin, ENBW is the bandwidth of an equivalent rectangular filter (having the same gain at the center frequency) that would collect the same power from a white noise signal.

Enhanced Resolution (ERES): A facility in LeCroy DSOs to increase the amplitude resolution of single-shot waveform measurements. This technique, which applies digital filtering to achieve resolution enhancement at a reduced bandwidth, is optimum when the sampling rate of the instrument exceeds that required for the input signal bandwidth. For repetitive signals, either ERES or Signal Averaging, or both, can be used to achieve higher resolution with substantially smaller loss of bandwidth than for single-shot signals.

Envelope: The maximum, minimum, or maximum and minimum values of a sequence of measured waveforms. In LeCroy DSOs, the number is programmable from 1 to 10^6 .

EPROM: Erasable, programmable read-only memory. An integrated circuit memory array that is made with a pattern of either all logical zeros or ones and has a pattern written into it by the user with a special hardware program.

Equivalent Time Sampling (EQT): (Also known as ETS.) A means of exploiting multiple acquisitions of a repetitive signal to increase the usable bandwidth of a digitizer by making it appear to sample more rapidly than its maximum single-shot sample rate. Works only with stable, repetitive signals.

Extrema: The computation of a waveform envelope, by repeated comparison of successive waveforms, of all maximum points (roof) and all minimum points (floor). Whenever a given data point of the new waveform exceeds the corresponding maximum value in the roof record, it is used to replace the previous value. Whenever a given data point of the new waveform is smaller than the corresponding floor value, it is used to replace the previous value.

Falltime: Unless otherwise defined, the time required for a pulse to go from 90 % to 10 % of full amplitude. Can also refer generally to the trailing edge of a pulse.

Fast Fourier Transform (FFT): In signal processing applications, an FFT is a mathematical algorithm that takes a discrete source waveform, defined over n points, and computes n complex Fourier coefficients, which are interpreted as harmonic components of the input signal. For a “real” source waveform (imaginary part equals 0), there are $n/2$ independent harmonic components.

Feedthrough: An unwanted signal that passes a closed gate or disabled input.

FFT: See Fast Fourier Transform.

FFT Frequency Bins: A Fast Fourier Transform (FFT) corresponds to analyzing the input signal with a bank of $n/2$ filters, all having the same shape and width, and centered at $n/2$ discrete frequencies. Each filter collects the signal energy that falls into the immediate neighborhood of its center frequency, and thus it can be said that there are $n/2$ “frequency bins.” The distance, in Hz, between the center frequencies of two neighboring bins is always: $\Delta f = 1/T$, where T is the duration of the time-domain records in seconds. The nominal width of bin is equal to Δf .

FFT Frequency Range: The range of frequencies computed and displayed in an FFT is 0 Hz to the Nyquist frequency.

FFT Frequency Resolution: In a narrow sense, the frequency resolution is equal to the bin width, Δf . That is, if the input signal changes its frequency by Δf , the corresponding spectrum peak will be displaced by Δf . For smaller changes of frequency, only the shape of the peak will change. However, the effective frequency resolution (i.e., the ability to resolve two signals whose frequencies are almost the same) is further

limited by the use of window functions. The ENBW value of all windows other than the rectangular is greater than Δf (i.e., greater than the bin width).

FFT Number of Points: FFT is computed over the number of points (Transform Size) whose upper bound is the source number of points. FFT generates spectra having $n/2$ output points.

FFT Total Power: Area under the power density spectrum in frequency-domain measurements.

FIFO: First-in, first-out shift registers (sometimes called first-in, first-out memory).

Filter: An electronic circuit or digital data manipulation routine that either enhances desirable or removes undesirable aspects of an analog waveform or its digital representation. Filters are used to block specific frequency components from passing through a circuit, to linearize otherwise identical components (such as CCDs) used in a common circuit, or to perform waveform integration, differentiation, or smoothing, just to name a few types.

Flash ADC: A very fast analog-to-digital converter, usually consisting of a large set of fast comparators and associated logic, in which the analog signal simultaneously is compared to $2^n - 1$ different reference voltages, where n is the ADC resolution. Also called a parallel converter.

Floor: The record of points that make the bottom (or minimum) of an envelope created from a succession of waveforms.

FWHM: Full-Width Half Maximum. The width of a pulse or waveform at 50 % amplitude used to measure the duration of a signal.

Gate: 1 A circuit element used to provide a logical function (e.g., AND, OR); **2** An input control signal or pulse enabling the passage of other signals.

Glitch: A spike or short-time duration structural aberration on an otherwise smooth waveform that is normally characterized by more gradual amplitude changes. In digital electronics, where the circuit under test uses an internal clock, a glitch can be considered to be any pulse narrower than the clock width.

Glitch Trigger: A trigger on pulse widths smaller than a given value.

Ground Loop: A long ground connection along which voltage drops occur due either to heavy circuit current or external pick-up, with the result that circuit elements referred to different points along it operate at different effective ground references.

HF Sync: Reduces the trigger rate by including a frequency divider in the trigger path, enabling the input trigger rate to exceed the maximum for repetitive signals.

Histogram: A graphical representation of data such that the data is divided into intervals or bins. The intervals or bins are then plotted on a bar chart where the height is proportional to the number of data points contained in each interval or bin.

Holdoff by Events: Selects a minimum number of events between triggers. An event is generated when the trigger source meets its trigger conditions. A trigger is generated when the trigger condition is met after the selected number of events from the last trigger. The hold-off by events is initialized and started on each trigger.

Holdoff by Time: Selects a minimum time between triggers. A trigger is generated when the trigger condition is met after the selected delay from the last trigger. The timing for the delay is initialized and started on each trigger.

HPGL: Hewlett-Packard Graphics Language Format; Hewlett-Packard Company.

Hybrid Circuit: A small, self-contained, high-density circuit element usually consisting of screened or deposited conductors, insulating areas, resistors, etc., with welded or bonded combinations of discrete circuit elements and integrated circuit chips.

IC: Integrated Circuit. A self-contained, multiple-element circuit such as a monolithic or hybrid.

Integral Linearity: A term often used inappropriately to mean integral non-linearity.

Integral Non-Linearity: Deviation of ADC response from an appropriate straight line fit. The specification is sometimes defined as maximum deviation, expressed as a fraction of full scale. More recent ADCs have a specification expressed as a percent of reading plus a constant.

Interleaved Clocking: Supplying clock pulses of equal frequency but different identical circuits or instruments in order to increase the system sample rate. For example, use of two transient recorders with inputs in parallel but complementary clocks to allow operation at twice the maximum rate of a single unit.

Interval Trigger: Selects an interval between two edges of the same slope. The trigger can be generated on the second edge if it occurs within the selected interval or after the selected interval. The timing for the interval is initialized and restarted whenever the selected edge occurs.

Jitter: Short-term fluctuations in the output of a circuit or instrument that are independent of the input.

Leakage: When observing the Power Spectrum of a sine wave having an integral number of periods in the time window using the rectangular window, leakage is the broadening of the base of the peak spectral component that accurately represents the source waveform's amplitude.

Limiter: A circuit element that limits the amplitude of an input (used for input protection, pulse standardizing, etc.).

Logical 1: A signal level indicating the TRUE state; corresponds to the unit being set (i.e., if interrogated, the answer is yes).

Logical 0: A signal level indicating the FALSE state; corresponds to the unit NOT being set (i.e., if interrogated, the answer is no).

Long-Term Stability: Refers to stability over a long time, such as several days or months.

MCA: multichannel analyzer (e.g., pulse height analyzer)

Mean Value: Average or DC level of all data points selected in a waveform.

Median Value: The data value of a waveform above and below which there are an equal number of data points.

Mode Value: The most frequently occurring data value of a waveform.

Monolithic IC: An integrated circuit whose elements (transistors, diodes, resistors, small capacitors, etc.) are formed on or within a semiconductor substrate.

Monotonic: A function with a derivative that does not change sign.

Multiplexer: A device used to selectively switch a number of signal paths to one input or output.

NAND: An AND circuit, except with a complementary (negative true) output.

Negation: The process of transposing all negative values into positives and all positive values into negatives.

NLTS: non-linear transition shift

Noise Equivalent Power: NEP (W); the RMS value of optical power that is required to produce unity RMS signal-to-noise ratio.

NOR: An OR circuit, except with a complementary (negative true) output.

NRZ: non-return to zero

Nyquist Frequency: The Nyquist frequency ($f/2$) is the maximum frequency that can be accurately measured by a digitizer sampling at a rate of f . In other terms, a digitizer sampling at a rate of f cannot measure an input signal with bandwidth components exceeding $f/2$ without experiencing "aliasing" inaccuracies.

Offset: The amount by which an analog or digital output or input baseline is shifted with respect to a specific reference value (usually zero).

OR: A logic circuit having the property that if at least one input is true, the output is true.

Overshoot, Negative: A time-domain parameter in waveform measurements, equal to the base value of a waveform minus the minimum sample value, expressed as a percentage of the amplitude.

Overshoot, Positive: A time-domain parameter in waveform measurements, equal to the maximum sample value minus the top value, expressed as a percentage of the amplitude. The top value is the most probable state determined from a statistical distribution of data point values in the waveform.

Parallel Converter: A technique for analog-to-digital conversion in which the analog signal is simultaneously compared to $2^n - 1$ different reference voltages, where n is the ADC resolution.

Pass/Fail Testing: Post-acquisition testing of a waveform against a reference mask or of waveform parameters against reference values.

PCMCIA: Personal Computer Memory Card Industry Association standard for PC memory cards. Also known as JEIDA in Japan.

PCX: The PC Paintbrush Format for graphic images; ZSoft Corporation, Marietta, GA.

Peak Spectral Amplitude: Amplitude of the largest frequency component in a waveform in frequency domain analysis.

Period: A full period is the time measured between the first and third 50 % crossing points (mesial points) of a cyclic waveform.

Persistence: A display operating mode of a DSO where a user-determined number of measured traces remain on the display without being erased and overwritten.

PES: position error signal

PHA (Pulse Height Analyzer): A device that gives a measure of the amplitude of a signal applied to its input.

Picket Fence Effect: In FFT, if a sine wave has a whole number of periods in the time-domain record, the Power Spectrum obtained with the rectangular window will have a sharp peak, corresponding exactly to the frequency and amplitude of the sine wave. If it does not, the spectrum obtained will be lower and broader. The highest point in the power spectrum can be 3.92 dB lower (1.57 times) when the source frequency is halfway between two discrete bin frequencies. This variation of the spectrum magnitude is called the Picket Fence Effect (the loss is called the Scallop Loss). All window functions compensate this loss to some extent, but the best compensation is obtained with the Flat Top window.

Power Spectrum: The square of the magnitude spectrum (V^2). The Power Spectrum is displayed on the dBm scale, with 0 dBm corresponding to $V_{\text{ref}}^2 = (0.316 \text{ V peak})^2$, where V_{ref} is the peak value of the sinusoidal voltage which is equivalent to 1 mW into 50 (ohms).

Power Density Spectrum: The Power Spectrum divided by the equivalent noise bandwidth of the filter (V^2/Hz), in Hz. The Power Density Spectrum is displayed on the dBm scale, with 0 dBm corresponding to ($V_{\text{ref}}^2/\text{Hz}$).

Pre-trigger Sampling: A design concept used in transient recording in which a predetermined number of samples taken before a stop trigger are preserved.

PRML: pulse response maximum likelihood

Pulse Width: Determines the duration between the Pulse Start (mesial point, i.e., the 50 % magnitude transition point, on the leading edge) and the Pulse Stop (mesial point on the trailing edge) of a pulse waveform.

Pulse Start: The 50 % magnitude transition point (mesial point) on the leading edge of a pulse waveform.

Pulse Stop: The 50 % magnitude transition point (mesial point) on the trailing edge of a pulse waveform.

Pulse Trigger: Selects a pulse width, either maximum or minimum. The trigger is generated on the selected edge when the pulse width is either greater than or less than the selected width. The timing for the width is initialized and restarted on the edge opposite to the edge selected.

RAM: A memory in which each data address can either be written into or read from at any time.

Random Interleaved Sampling (RIS): One method of EQT (or ETS). Acting upon stable, repetitive signals, it represents the process of storing different full sampling sweeps in a DSO or digitizer system, where each sweep is slightly offset from the other to achieve a higher effective sampling rate than the single-shot rate. A major advantage of RIS over other EQT techniques is “pretrigger viewing”

Real Time: A process that occurs without having to pause for internal conversions and references. Real Time processes usually have little or no intrinsic dead time and are able to proceed at a rate that permits almost simultaneous transitions from inputs to outputs.

Reciprocal: The division of unity by the data value being processed.

Reflection Coefficient: The amount of signal amplitude that is reflected from an input, expressed as a percentage of the original input signal.

Resolution: The minimum measurable increment, such as one bit level of an ADC.

Reverse Termination: An output so constructed that pulses reflected back from the rest of the system meet a matching impedance and are absorbed.

RF (Radio Frequency): Normally in the megahertz range.

RFI (Radio Frequency Interference): A special case of EMI wherein the field causing the induced signal falls into the radio portion of the electromagnetic spectrum.

Risetime: Unless otherwise defined, the time required for a pulse to go from 10 % to 90 % of full amplitude. Can also refer generally to the leading edge of a pulse.

RMS (Root Mean Square): Is derived from the square root of the average of the squares of the magnitudes, for all the data as described above. For time-domain waveforms, the square root of the sum of squares divided by the number of points for the part of the measured waveform between the cursors. For histogram waveforms, the square root of sum of squares divided by number of values computed on the distribution.

ROM: Read-only memory is any type of memory that cannot be readily rewritten. The information is stored on a permanent basis and used repeatedly. Usually randomly accessible.

Roof: The record of points that make the top (or maximum) of an envelope created from a succession of waveforms.

SAM: sequenced amplitude margin

Sample and Hold: A circuit that, on command, stores on a capacitor the instantaneous amplitude of an input signal.

Sampling Frequency: The clock rate at which samples are taken during the process of digitizing an analog signal in a DSO or digitizer.

Scallop Loss: Loss associated with the picket fence effect.

SECAM: sequence and memory color television system

Sensitivity: **1.** The minimum signal input capable of causing an output signal with the desired characteristics. **2.** The ratio of the magnitude of the instrument response to the input magnitude (e.g. a voltage ADC has a sensitivity that is usually measured in counts/mV). Often, sensitivity is referred to the input and is therefore stated as the inverse.

Shot Noise: Noise caused by current fluctuations, due to the discrete nature of charge carriers and random emission of charged particles from an emitter. Many refer to shot noise loosely, when speaking of the mean square shot noise current (amps) rather than a noise power (watts).

SMART Trigger: The SMART Trigger allows the setting of additional qualifications before a trigger is generated. These qualifications can be used to capture rare phenomena such as glitches or spikes, specific logic

states or missing bits. One qualification can include, for example, generating a trigger only on a pulse wider or narrower than specified.

Smoothing, N-Point: The process of evening out the display of a waveform by displaying a moving average of “N” adjacent data points added to each other.

SNR: Signal-to-Noise Ratio is the ratio of the magnitude of the signal to that of the noise.

Square: The process of multiplying a value by itself.

Stage Delay: The time delay in a circuit between input and output, usually measured between the front edges (half maximum) of the respective signals.

Standard Deviation: The standard deviation of the measured points from the mean. It is calculated from the following formula:

Standard Trigger: Standard Trigger causes a trigger to occur whenever the selected trigger source meets its conditions, which are defined by the trigger level, coupling, high-frequency sync, and slope. Edge trigger is Waverunner’s standard trigger type.

State Qualified: State-Qualified triggering generates a trigger when the trigger source meets its conditions during the selected pattern. A pattern is defined as a logical AND combination of trigger states. A trigger state is either high or low — high when a trigger source is greater than the trigger level, and low if it is less than the trigger level.

Stop Trigger: A pulse that is used to stop a transient recording or similar sequence.

Summed, or Summation, Averaging: The repeated addition, with equal weight, of successive waveforms divided by the total number of waveforms acquired.

TAA: track average amplitude

TDC: Time-to-digital converter.

Terminate: Normally, to provide a matching impedance at the end of coaxial cable to prevent reflections.

Test Template: A general form of waveshape limit test, which defines an arbitrary limit (or non-uniform tolerance) on each measured point in a waveform.

TFT: thin film transistor

Threshold: The voltage or current level at which a circuit will respond to a signal at its input. Also referred to as trigger level.

TIE: time interval error

TIFF (Tagged Image File Format): Industry standard for bit-mapped graphic files.

Time Between Patterns: Selects a delay, either maximum or minimum, between exiting one pattern and entering the next. The trigger is generated on entering the second pattern either within the selected time or after the selected minimum time.

Timeout: A Timeout occurs when a protective timer completes its assigned time without the expected event occurring. Timeouts prevent the system from waiting indefinitely in case of error or failure.

Time Qualified: Time-Qualified triggering generates a trigger when the trigger source meets its trigger condition after entering or exiting the pattern. The trigger can occur even if the pattern disappears before the trigger meets its trigger conditions.

Tolerance Mask: A form of waveshape limit test that defines a maximum deviation equal to a uniform tolerance on each measured point in a waveform.

Track and Hold: A circuit preceding an analog-to-digital converter that has the ability on command to store instantaneous values of a rapidly varying analog signal. Allows the ADC to accurately digitize within tighter time domains.

Transient Recorder: See Waveform Digitizer.

TTL (Transistor-Transistor Logic): Signal levels defined as follows: LOGICAL 0 = 0 to 0.8 V and LOGICAL 1 = 2.0 to 5.0 V.

Trend: Plot of a parameter value or other characteristic of a measurement over a period of time.

VIS: Viterbi input samples

Waveform Digitizer: An instrument that samples an input waveform at specified intervals, digitizes the analog values at the sampled points, and stores the results in a digital memory.

Window Functions: Used to modify the spectrum of a truncated waveform prior to Fourier analysis. Alternately, window functions determine the selectivity (filter shape) in a Fourier transform spectrum analyzer. In LeCroy scopes, all window functions belong to the sum of cosines family with one to three non-zero cosine terms [$W = \dots a_m \cos(2^{1/4} k/N)$, where N is the number of points in the decimated source waveform, and k is the time index].

X-Y Display: A plot of one trace against another trace. This technique is normally used to compare the amplitude information of two waveforms. It can reveal phase and frequency information through the analysis of patterns called Lissajous figures.



BLANK PAGE